

AMiLA®

ELDICO
sport

1978 **45** ΧΡΟΝΙΑ 2023

καταλόγος και
τιμολογιαρχαίο

2024

Σύμβουλος Αγορών

AMiLA®

in impulse

ReNeGaDE

SPIRIT

SOLE

TOTAL GYM 

BODYCRAFT





Οι Επιλογές Μας Δηλώνουν Ποιοί Είμαστε

Στην **ΕΛΔΙΚΟ** όλα είναι μία αλυσίδα αποτελούμενη από συνεργάτες και προμηθευτές, η οποία στηρίζεται σε διαδικασίες δοκιμασμένες στο χρόνο.

Σε επίπεδο brand name δημιουργήσαμε τα **ESCAPE** και **AMILA**, τα οποία αυτή τη στιγμή αναπτύσσουμε περαιτέρω. Βάζοντας τον πελάτη στο κέντρο των διαδικασιών μας, επιδιώκουμε να γίνουμε πρότυπο πελατοκεντρικής εταιρείας και πρώτη επιλογή των πελατών μας.

Αγαπάμε τους ανθρώπους μας, αγαπάμε και σεβόμαστε τους πελάτες μας και προσπαθούμε μέσα από την ομαδική εργασία να τους υπηρετήσουμε σωστά **κερδίζοντας έτσι επάξια και τον δικό τους σεβασμό.**

ISO 9001:2015

Για να εξασφαλίσει την ποιότητα και ασφάλεια των προϊόντων της, η **ΕΛΔΙΚΟ** φρόντισε να εγκαταστήσει στις λειτουργίες της Σύστημα Διασφάλισης Ποιότητας [ΣΔΠ] σύμφωνα με το Διεθνές πρότυπο **ISO 9001:2015**.

Πρακτικά, αυτό σημαίνει ότι η **ΕΛΔΙΚΟ** πέρασε από όλα τα απαιτούμενα στάδια προετοιμασίας και πλέον περνάει με επιτυχία τις επιθεωρήσεις που πραγματοποιούνται μία ή δύο φορές το χρόνο.

Με το **ISO 9001:2015** διασφαλίζεται η εισαγωγή, η παραλαβή, η παραγγελιοληψία, η συσκευασία και αποστολή των προϊόντων της μέσα από **συνεχείς, αυστηρούς ελέγχους** που αποτελούν αναπόσπαστο κομμάτι της λειτουργίας της.

Η δέσμευση **ISO 9001:2015** συνάδει με την επιθυμία της **ΕΛΔΙΚΟ** να δείχνει τον μέγιστο σεβασμό στον πελάτη της, να αντιμετωπίζει με σοβαρότητα και επαγγελματισμό κάθε πιθανό πρόβλημα και να κινείται ανοιχτά για την επικοινωνία και την επίλυσή του.

Εφαρμόζοντας τη νομοθεσία τόσο του ελληνικού κράτους, όσο και της Ευρωπαϊκής Ένωσης σχετικά με την ασφαλή φύση των προϊόντων της και την ασφάλεια των καταναλωτών, η **ΕΛΔΙΚΟ** εκπληρώνει ουσιαστικά τη φιλοδοξία της να έχει στο επίκεντρο της προσοχής της τον πελάτη, οικοδομώντας γύρω του ένα **Σύστημα Διασφάλισης Ποιότητας** που τον εξασφαλίζει σε όλα τα επίπεδα.



Το Όραμά Μας

Να είμαστε μια πρωτοπόρα εταιρεία με ισχυρό brand name και καινοτόμα προϊόντα, πρότυπο για πελάτες και ανταγωνιστές, πρώτη επιλογή για συνεργάτες. Μέσω της μάθησης, της προσωπικής ανέλιξης και της ουσιαστικής συμμετοχής στην πρόοδό της να καλλιεργεί στους εργαζομένους της κουλτούρα οργάνωσης, καινοτομίας, ομαδικής εργασίας και πνεύμα αλληλοσεβασμού εντός και εκτός εταιρείας.



Εταιρική Κοινωνική Ευθύνη

Η **ΕΛΔΙΚΟ ΣΠΟΡ ΜΟΝ. ΑΕΕ** πρωτοπορεί στον κλάδο των εισαγωγών και της εμπορίας αθλητικών, εποχιακών και ειδών εξοχής, ενώ παράλληλα πρωτοστατεί στο σύστημα Εναρτηλακτικής Διαχείρισης.

Η προστασία του περιβάλλοντος αποτελεί σημαντική της βίβληση, γι' αυτό και συμμετέχει στο **Σύστημα Συη. Εναρτηλακτικής Διαχείρισης "ΑΝΑΚΥΚΛΩΣΗ"** της Ελληνικής Εταιρείας Αξιοποίησης Ανακύκλωσης ενώ παράλληλα υλοποιεί **πρόγραμμα μείωσης του πλαστικού στις συσκευασίες**, αντικαθιστώντας το με ανακυκλώσιμο χαρτί.

Η **ΕΛΔΙΚΟ ΣΠΟΡ ΜΟΝ. ΑΕΕ**, στα πλαίσια της **Εταιρικής Κοινωνικής Ευθύνης**, έχει τη χαρά να βοηθά την προσπάθεια του φοιτητικού σωματείου **"Circle Club"**, που δραστηριοποιείται στους τομείς του μπάσκετ, του ποδοσφαίρου, του τένις, και του cheerleading, μέσα από τα προϊόντα που παρέχει δωρεάν για τις προπονήσεις και τα πρωταθλήματα που συμμετέχουν.





- ◀ Επίσκεψη στο εργοστάσιο κατασκευής πάγκων της AMILA. Επιθεώρηση βαφής και laser cut.



- ▲ Η ποιότητα της συσκευασίας και της προστασίας των προϊόντων πριν συσκευαστούν σε κουτιά, είναι ζωτικής σημασίας για την προστασία των προϊόντων κατά την μεταφορά και αποθήκευση. Η γνώση για όλα τα στάδια της συσκευασίας είναι σημαντική για την κατανόηση της προσφερόμενης ποιότητας από το εργοστάσιο.

Επιλογή Προμηθευτών

Η επιλογή των κατάλληλων προμηθευτών γίνεται μέσα από μια εκτεταμένη τράπεζα πληροφοριών η οποία **εμπλουτίζεται συνεχώς από τις επισκέψεις και επαφές μας σε διεθνείς εκθέσεις.**

Τα κριτήρια μας είναι αυστηρά αναφορικά με την ποιότητα των προσφερόμενων προϊόντων και βασίζονται σε μια δυνατή - αμφίδρομη σχέση επικοινωνίας.

Συνεργαζόμαστε με εργοστάσια που κατασκευάζουν ποικίλα προϊόντα, τα οποία προμηθεύουν, επίσης, επώνυμα brands και φυσικά είναι **πιστοποιημένα με ISO**, ώστε να έχουμε εξασφαλισμένη την οργάνωση και την εξυπηρέτηση από μέρους τους.

Έχουμε επιλέξει ορισμένα από τα καλύτερα εργοστάσια της Κίνας, της Ταϊβάν και του Πακιστάν, με στελέχη που γνωρίζουν καλά την αγγλική γλώσσα, προς αποφυγή παρανοήσεων, τα οποία ανταποκρίνονται σε κάθε μας αίτημα, ηλεκτρονικώς, εντός μίας ημέρας.

Πάγια πολιτική μας είναι να παραμένουμε πιστοί στους προμηθευτές μας, καθώς **επενδύουμε χρόνο και χρήμα στη συνεργασία μας** -με πολυημερές επισκέψεις στα εργοστάσιά τους για επιτόπου έρευνα- ώστε να έχουμε τη βέλτιστη συνεργασία.

Επιλογή Προϊόντων

Το τμήμα πωλήσεων μας μεταφέρει τις δικές σας προτάσεις ώστε να καλύψουμε τυχόν κενά στην αγορά, ενώ το τμήμα εισαγωγών συγκεντρώνει στοιχεία, ώστε να καθορίσει τόσο τις προδιαγραφές των νέων προϊόντων, όσο και την επιθυμητή τιμή αγοράς.



- ▲ Επίσκεψη στο εργοστάσιο κατασκευής δίσκων της AMILA. Επιθεώρηση διαδικασίας πλαστικοποίησης.

Οι διαδικασίες μας αποτελούν εγγύηση επιτυχίας

Η ΕΛΔΙΚΟ ΣΠΟΡ ΜΟΝ. ΑΕΕ έχει καθορίσει διαδικασίες τις οποίες ακολουθεί προκειμένου να πετύχει:

- Ποιότητα Προϊόντων
- Διαθεσιμότητα Προϊόντων
- Αποθέματα Ανταλλακτικών

Εξασφαλίζουμε τους Συνεργάτες μας

Η πολυχρόνη εμπειρία μας, η βαθιά γνώση της ελληνικής αγοράς και κυρίως κάθε προϊόντος, είναι στη διάθεσή σας ώστε να είμαστε πάντα σε θέση να σας εξασφαλίσουμε κάτι ακόμα καλύτερο. Απόδειξη το γεγονός ότι **έχουμε βελτιώσει όλα τα προϊόντα που εισάγουμε**, ώστε να ανταποκρίνονται στις απαιτήσεις μας και να είναι όλα λειτουργικά, ακόμα και αυτά που διατίθενται σε ιδιαίτερα ελκυστικές τιμές.

1. Σας παρέχουμε ποιοτικά σωστά **προϊόντα με συγκεκριμένες προδιαγραφές**, χωρίς λάθη, από έμπειρους προμηθευτές που έχουμε εκπαιδεύσει.
2. Σας προμηθεύουμε με προϊόντα **σταθερά υψηλής ποιότητας**.
3. Σας εξασφαλίζουμε **διαχρονικά σωστό service**.
4. Κερδίζουμε την εμπιστοσύνη σας στα προϊόντα μας χάρη στην **απόρροια ομαλή συνεργασία μας**.



Μηχανογράφηση

Η **ELDICO** είναι πλήρως μηχανογραφημένη στα πρότυπα **ERP [Enterprise Resource Planning]** και διαθέτει 3 servers, τελευταίας γενιάς, με 5 δίσκους έκαστος (raid) για μεγαλύτερη ασφάλεια.



Ζύγιση
ποιοτικός έλεγχος
και έλεγχος με
χρήση barcode scanner

Άφιξη

1. Κατά την άφιξη του κοντέινερ στα ειδικά ντοκ, γίνεται προσεκτική εκφόρτωση των προϊόντων χρησιμοποιώντας τα πλέον κατάλληλα μέσα, ανάλογα με το είδος και την συσκευασία του εμπορεύματος.
2. Κατά την διάρκεια της εκφόρτωσης γίνεται ένας συνοπτικός έλεγχος που αφορά:
 - Προδιαγραφές, χρώματα, barcodes και κωδικούς.
 - Ελέγχεται η συσκευασία ώστε να είναι σε άριστη κατάσταση. Εάν βρεθεί απόκλιση, αποθηκεύεται σε ιδιαίτερο μέρος.
3. Στο τέλος, ακολουθεί καταχώρηση και εισαγωγή στην αποθήκη με χρήση barcode scanners.



Φύλαξη

Η αποθήκη που φιλοξενεί τα προϊόντα είναι καθαρή και τακτοποιημένη, ενώ η ύπαρξη υπευθύνων περιοχών και οι εβδομαδιαίοι έλεγχοι μας έχουν αποφέρει 98% σωστές θέσεις/ράφι και 97% καθαρά εμπορεύματα.

Σε έναν ιδιόκτητο χώρο συνολικής έκτασης 4200m² για γραφεία και αποθήκες, στο Βοτανικό, βρίσκεται το κεντρικό κτήριο της ΕΛΔΙΚΟ.



Αποψη της αποθήκης μας στη Θεσ/νίκη, συνολικής έκτασης 4300m² με δυνατότητα αποθήκευσης 85 container 40HQ.

Παραγγελιοδηψία

Γίνεται από τη γραμματεία πωλήσεων και από τους πωλητές σε Αθήνα και Θεσ/νίκη. Τόσο οι πωλητές όσο και η γραμματεία πωλήσεων και οι συντονιστές παραγγελιών εκτός της πολυετούς πείρας (οι περισσότεροι πάνω από 15 χρόνια), εκπαιδεύονται διαρκώς και είναι σε θέση να απαντούν στις ερωτήσεις σας και να σας συμβουλεύουν για την αγορά ή τη χρήση των προϊόντων που σας ενδιαφέρουν.

Το ψηφιακό τηλεφωνικό κέντρο μας επιτρέπει να **ανοίγουμε αυτομάτως την καρτέλα** και να **εισάγουμε άμεσα την παραγγελία σας**, η οποία ενδέχεται ακόμα και να καταγραφεί, για την αποφυγή οποιουδήποτε πιθανού λάθους.



Οι εγκαταστάσεις και ο στόλος οχημάτων των αποθηκών της ΕΛΔΙΚΟ στη Βόρεια Ελλάδα.

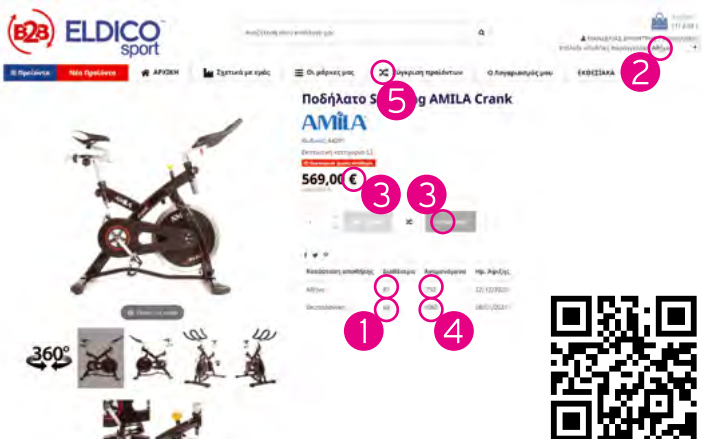

Η ανανεωμένη πλατφόρμα B2B (Business to Business)

Η υπηρεσία είναι συνδεδεμένη με το εμπορικό πρόγραμμα της εταιρίας ώστε να παρέχει άμεσα και σε πραγματικό χρόνο πληροφόρηση.

Εκτός από τις διαθεσιμότητες των προϊόντων, σε κάθε μια από τις δύο αποθήκες μας (1), οι εγγεγραμμένοι χρήστες μπορούν να επιλέξουν την αποθήκη παραγγελίας τους (2) και να δουν την χονδρική τιμή καταλόγου και την τιμή αγοράς τους (3). Επίσης, παρέχεται η πληροφόρηση για την αναμενόμενη ποσότητα καθώς και για την ημερομηνία επόμενης παραλαβής (4).

Επιπλέον, από την λίστα των προϊόντων κάθε κατηγορίας, μπορούν να προστεθούν προϊόντα στη λίστα σύγκρισης (5) και να εμφανιστούν, σε στήλες, τα χαρακτηριστικά των επιλεγμένων προϊόντων.

Δείτε το δίκτυο **επιλεγμένων συνεργατών** μας στη διεύθυνση **eldico.gr/partners** ▶



Τα προϊόντα της ΕΛΔΙΚΟ βρίσκονται σε περισσότερα από 5.000 σημεία πώλησης. Από αυτά περίπου 1.600 αφορούν απ' ευθείας πωλήσεις και 3.500 είναι σημεία πώλησης μέσω 50 μεγάλων συνεργατών. Στα Βαλκάνια και στην Κύπρο η ΕΛΔΙΚΟ έχει παρουσία σε 50 επιπλέον σημεία πώλησης, κυρίως απ' ευθείας.

Με **έμφαση στην ποιότητα**, η αποστολή των εμπορευμάτων αποτελεί πολύ σημαντικό κριτήριο για την ΕΛΔΙΚΟ ΣΠΟΡ ΜΟΝ. ΑΕΕ και ένα από τα τρία (3) βασικότερα κριτήρια για την πιστοποίησή μας.



Εκτέλεση Παραγγελιών

Το προσωπικό της αποθήκης μας διαθέτει εμπειρία ετών, γι' αυτό και μπορεί να κάνει picking του σωστού κωδικού, **χωρίς οποιοδήποτε ελάττωμα** στα προϊόντα ή την συσκευασία τους.

Στη συνέχεια, κάθε παραγγελία κατεβαίνει στον χώρο συσκευασίας και **σκανάρεται τεμάχιο προς τεμάχιο**, ώστε να γίνει **οργανωμένη και σωστή αποστολή**, μηδενίζοντας έτσι την εμφάνιση λαθών.

Μετά τον τελικό έλεγχο ποσότητας και την επιβεβαίωση του κωδικού, συμπληρώνεται ο αριθμός του κιβωτίου και ο υπεύθυνος το συσκευάζει καλά, δίνοντας σημασία στη σωστή αναγραφή ονομάτων και αριθμού δεμάτων, ενώ παράλληλα φροντίζει να γίνει με ταχύτητα και ασφάλεια η φόρτωση.

Σημαντικό είναι το γεγονός πως **το τιμολόγιό μας αποτελεί ταυτόχρονα packing list** ώστε η παραλαβή να γίνεται χωρίς λάθη και απρόοπτα.



Στην προσπάθειά μας να βελτιώσουμε την έκδοση του καταλόγου μας, λαμβάνουμε πάντοτε σοβαρά υπόψη μας τα σχόλια και τις παρατηρήσεις σας, για τις οποίες σας ευχαριστούμε θερμά.

Βελτιώνουμε συνεχώς τον κατάλογο μας ακολουθώντας τις βέλτιστες πρακτικές στην παρουσίαση προϊόντων, και φροντίζοντας να τον κάνουμε κάθε χρόνο πιο λειτουργικό. Πιστεύουμε ακράδαντα ότι ο παρών κατάλογος θα γίνει χρήσιμο εργαλείο στα χέρια σας για την ολοκληρωμένη ενημέρωσή σας, εφόσον μπορεί να σας βοηθήσει στην σωστή επιλογή των προϊόντων σας.

Επίσκεψη του τεχνικού μας στο εργοστάσιο κατασκευής κινητήρων ► για ενημέρωση και έλεγχο της ποιότητας των διαδικασιών του εργοστασίου.

Φόρτωση

Τα προϊόντα αναχωρούν **άριστα συσκευασμένα** από τις εγκαταστάσεις μας, ώστε να αποφεύγεται κάθε δυσάρεστη έκπληξη από εμπλεκόμενες εταιρείες μεταφορών.



Διανομή

Η διανομή πραγματοποιείται με **3 μεγάλα (10T)** και **3 μικρότερα ιδιόκτητα φορτηγά (5T)**, που εξασφαλίζουν την απαιτούμενη ταχύτητα εξυπηρέτησης, την αμεσότητα και -κυρίως- την ασφάλεια στις μεταφορές.

Ο συντονισμός της παράδοσης είναι αρμοδιότητα του υπεύθυνου της αποθήκης ώστε να είμαστε σίγουροι ότι θα είμαστε **απόλυτα συνεπείς απέναντί σας**.



Έρευνα και Εξέλιξη

Σε συνεργασία με τη **Σχολή Επιστημών Υγείας & Πρόνοιας του Πανεπιστημίου Δυτικής Αττικής**, για το πρόγραμμα "Εκπαίδευση και Θεραπευτική Άσκηση με την εφαρμογή της μεθόδου Clinical Pilates" του **Κέντρου Δια Βίου Μάθησης η ΕΛΔΙΚΟ** βρίσκεται σε διαρκή επαφή, διαθέτοντας τα προϊόντα **AMILA** για τις ανάγκες των προγραμμάτων και των εργαστηριακών μετρήσεων που εκπονούνται, λαμβάνοντας σημαντικές πληροφορίες για την εξέλιξη των βοηθημάτων που παρέχει.



Διαρκής Εκπαίδευση

Στην προσπάθειά μας να σας εξυπηρετούμε καλύτερα, ακολουθούμε τη **φιλοσοφία διαρκούς εκπαίδευσης**. Το προσωπικό της αποθήκης εκπαιδεύεται τακτικά σε θέματα logistics, συσκευασίας, μηχανογράφησης, ασφάλειας αποθήκης και πυρόσβεσης. Η γραμματεία πωλήσεων και οι πωλητές εκπαιδεύονται τακτικά και έχουν τη δυνατότητα να απαντήσουν στις περισσότερες ερωτήσεις σας, καθώς και να σας βοηθήσουν να επιλέξετε τα σωστά εμπορεύματα για τις ανάγκες των πελατών σας.

Δημιουργία Περιεχομένου

Οι σύγχρονες απαιτήσεις της ψηφιακής εποχής δημιουργούν συνεχώς ανάγκες για ορθότατα και πλουσιότερο περιεχόμενο. Το τμήμα Marketing της **ΕΛΔΙΚΟ** επανδρώθηκε με νέο προσωπικό που εξειδικεύεται στην **κατασκευή φωτογραφιών 360 μοιρών***, **videos συναρμολόγησης και λειτουργίας, ασκησιοδημιουργιών και κειμένων** σε συνεργασία με επιστήμονες φυσικής αγωγής και personal trainers, που σκοπό έχουν τη δημιουργία **εργαλείων προώθησης** τα οποία θα κάνουν τον υποψήφιο χρήστη να αισθάνεται όχι απλά ότι γνωρίζει αλλά πως **κρατά στα χέρια του το προϊόν, πριν καν το αποκτήσει**.



* Επικοινωνήστε μαζί μας για να σας κατευθύνουμε για την παροχή και χρήση των φωτογραφιών 360°.

Επενδύοντας διαρκώς στο ανθρώπινο δυναμικό, η ΕΛΔΙΚΟ ΣΠΟΡ ΜΟΝ. ΑΕΕ στελεχώνεται από **καταρτισμένο προσωπικό**, με **υψηλή εξειδίκευση** (οικονομολόγους, γυμναστές, μηχανικούς, τεχνολόγους) και **πολυετή εμπειρία** στο αντικείμενο ενασχόλησής τους.

Στοχεύοντας πάντα στις σύγχρονες ανάγκες της εποχής και τις απαιτήσεις που έχουν σε πολυσιχιδείς γνώσεις, η εταιρεία, παράλληλα με τις επενδύσεις σε τεχνολογικά μέσα, εφαρμόζει συνεχές πρόγραμμα επιμόρφωσης του προσωπικού μέσω των εσωτερικών διαδικασιών εκπαίδευσης του Συστήματος Ποιότητας (ISO 9001:2015) και συμμετοχών σε επιμορφωτικά σεμινάρια τρίτων φορέων.

ΑΚ ΧΕΙΡΙΣΤΗΣ SCANNER



Αγνης ΚΑΦΡΙΤΣΑΣ

Αποθηκάριος

Εσωτερικός Αριθμός: 114
nth@eldico.gr

ΝΘ ΜΗΧΑΝΟΓΡ. ΑΠΟΘΗΚΗΣ



Νίκος ΘΩΜΑΪΔΗΣ

Υπ. Μην/φρησης Αποθήκης

Εσωτερικός Αριθμός: 114
nth@eldico.gr

ΒΔ ΕΚΤΕΛΕΣΗ ΠΑΡΑΓΓΕΛΙΩΝ



Βασίλης ΔΕΜΠΗ

Εκτέλεση Παραγγελιών

Εσωτερικός Αριθμός: 124

ΘΒ ΧΕΙΡΙΣΤΗΣ SCANNER



Αθανάσιος ΒΑΡΔΑΚΑΣ

Χειριστής Scanner

Εσωτερικός Αριθμός: 124

ΑΤ ΕΚΤΕΛΕΣΗ ΠΑΡΑΓΓΕΛΙΩΝ



Αθηνάο ΤΡΕΜΠΙΣΚΑ

Εκτέλεση Παραγγελιών

Εσωτερικός Αριθμός: 124

Το δυνατότερο κομμάτι της εταιρείας είναι οι άνθρωποί της...
...και οι Πελάτες η Πρώτη μας Προτεραιότητα

ΓΜ ΟΔΗΓΟΣ



Γιάννης ΜΑΓΙΝΑΣ

Οδηγός

Εσωτερικός Αριθμός: 124
Τηλέφωνο: 6945 934803

ΔΜ ΟΔΗΓΟΣ



Δημ. ΜΑΣΤΡΟΓΙΑΝ/ΛΟΣ

Οδηγός

Εσωτερικός Αριθμός: 124
Τηλέφωνο: 6959 997120

ΑΚ ΟΔΗΓΟΣ



Άγνης ΚΟΛΙΑΣ

Οδηγός

Εσωτερικός Αριθμός: 124

ΜΜ ΒΟΗΘΟΣ ΑΠΟΘΗΚΗΣ



Μαρίνος ΜΗΤΡΟΣΗΣ

Βοηθός Αποθήκης

Εσωτερικός Αριθμός: 124

ΠΣ ΒΟΗΘΟΣ ΑΠΟΘΗΚΗΣ



Πέτρος ΣΚΕΜΠΙ

Βοηθός Αποθήκης

Εσωτερικός Αριθμός: 124

ΑΤ ΑΠΟΘΗΚΑΡΙΟΣ



Λευτέρης ΤΣΑΜΠΟΥΡΑΣ

Αποθηκάριος

Εσωτερικός Αριθμός: 210
Τηλέφωνο: 6955 440986

ΧΤ ΒΟΗΘΟΣ / ΟΔΗΓΟΣ



Χρήστος ΤΖΙΜΑΣ

Οδηγός - Βοηθός Αποθήκης

Εσωτερικός Αριθμός: 210
Τηλέφωνο: 6956 036266

ΑΜ ΒΟΗΘΟΣ ΑΠΟΘΗΚΗΣ



Αναστ. ΜΗΤΣΙΚΟΥΔΗΣ

Βοηθός Αποθήκης

Εσωτερικός Αριθμός: 210

ΘΜ ΒΟΗΘΟΣ ΑΠΟΘΗΚΗΣ



Θανάσης ΜΠΑΚΙΡΤΖΗΣ

Βοηθός Αποθήκης

Εσωτερικός Αριθμός: 210

ΜΔ ΕΣΩΤΕΡΙΚΕΣ ΕΡΓΑΣΙΕΣ



Μαρία ΔΕΛΗ

Εσωτερικές Εργασίες

Εσωτερικός Αριθμός: 210

Η εταιρεία δεν φέρει καμία ευθύνη για τυχόν τυπογραφικά λάθη και χρωματικές διαφορές λόγω εκτύπωσης που μπορεί να υπάρξουν στο συγκεκριμένο κατάλογο. Δεν υπάρχει δυνατότητα προεπιλογής χρωματισμού εκτός από αυτά που ήδη παράγει κάθε συνεργάτης της.

Η εταιρεία δεν ευθύνεται σε περίπτωση εξάντλησης των αποθεμάτων στα είδη και διατηρεί το δικαίωμα αλλαγής των αναγραφόμενων τιμών καθ' όλη τη διάρκεια του έτους. Παρακαλούμε για οποιαδήποτε απορία απευθυνθείτε στον πωλητή σας ή στο eMail: support@eldico.gr

✎ ΧΓ ΤΙΜΟΛΟΓΗΣΗ-ΕΞΥΠΗΡΕΤΗΣΗ



Χρήστος ΓΚΟΓΚΑΚΗΣ
Τιμολόγηση - Εξυπηρέτηση
Εσωτερικός Αριθμός: 208
cg@eldico.gr
Τηλέφωνο: 6945 896511

✎ ΓΒ ΣΥΜΒΟΥΛΟΣ ΑΓΟΡΩΝ



Γιάννης ΒΑΦΕΙΑΔΗΣ
Σύμβουλος Αγορών
Εσωτερικός Αριθμός: 207
vi@eldico.gr
Τηλέφωνο: 6974 142224

✎ ΓΝ ΣΥΜΒΟΥΛΟΣ ΑΓΟΡΩΝ



Γιώργος ΝΤΑΝΑΣΗΣ
Σύμβουλος Αγορών
Εσωτερικός Αριθμός: 105
gdan@eldico.gr
Τηλέφωνο: 6951 953364

✎ ΓΛ ΣΥΜΒΟΥΛΟΣ ΑΓΟΡΩΝ



Γιώργος ΛΑΝΤΖΑΚΗΣ
Σύμβουλος Αγορών
Εσωτερικός Αριθμός: 110
geolan@eldico.gr
Τηλέφωνο: 6948 208581

✎ ΘΡ ΣΥΜΒΟΥΛΟΣ ΑΓΟΡΩΝ



Θοδωρής ΡΟΚΑΣ
Σύμβουλος Αγορών
Εσωτερικός Αριθμός: 111
rokas@eldico.gr
Τηλέφωνο: 6945 558854

✎ ΙΚ ΤΗΛΕΦΩΝΙΚΟ ΚΕΝΤΡΟ



Ιωάννα ΚΑΣΣΑΡΗ
Τηλεφωνικό Εξυπηρέτηση
Εσωτερικός Αριθμός: 104
joanna@eldico.gr

✎ ΚΦ ΥΠ. ΜΗΧΑΝΟΓΡΑΦΗΣΗΣ



Κώστας ΦΡΑΓΚΟΥΛΗΣ
Τιμολόγηση - Μηχαν/φισα
Εσωτερικός Αριθμός: 112
fragoulis@eldico.gr
Τηλέφωνο: 6946 904595

✎ ΘΜ ΥΠΟΣΤΗΡΙΞΗ ΠΩΛΗΣΕΩΝ



Θωμάς ΜΑΝΤΖΙΟΣ
Υποστήριξη Πωλήσεων
Εσωτερικός Αριθμός: 126
sbo@eldico.gr

✎ ΧΖ ΥΠΕΥΘΥΝΟΣ ΑΓΟΡΩΝ



Χρήστος ΖΕΡΒΑΣ
Υπεύθυνος Αγορών
Εσωτερικός Αριθμός: 125
buyer@eldico.gr

✎ ΝΔ ΥΠΕΥΘΥΝΟΣ ΕΙΣΑΓΩΓΩΝ



Νίκος ΔΟΥΛΟΥΓΕΡΗΣ
Υπεύθυνος Εισαγωγών
Εσωτερικός Αριθμός: 107
imports@eldico.gr

✎ ΜΣ ΤΙΜΟΛΟΓΗΣΗ - ΜΗΧ/ΦΙΣΗ



Μανώλης ΣΟΥΡΗΣ
Τιμολόγηση - Μηχαν/φισα
Εσωτερικός Αριθμός: 209
sales.the@eldico.gr

✎ ΒΣ ΤΕΧΝΙΚΟΣ - ΟΔΗΓΟΣ



Βασίλης Χ΄ΚΑΜΑΡΗΣ
Τεχνικός - Οδηγός
Εσωτερικός Αριθμός: 215
service.the@eldico.gr
Τηλέφωνο: 6943 076045

✎ ΒΜ ΤΕΧΝΙΚΟΣ



Βασίλης ΜΑΝΕΤΖΗΣ
Τεχνικός
Εσωτερικός Αριθμός: 122
service.ath@eldico.gr
Τηλέφωνο: 6946 904598

✎ ΧΓ ΤΕΧΝΙΚΟΣ

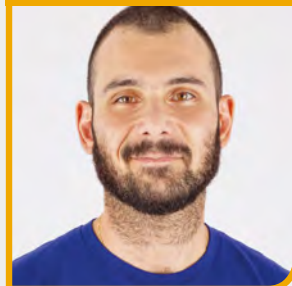

Χριστόφ. ΓΙΑΛΛΑΜΙΔΗΣ
Τεχνικός
Εσωτερικός Αριθμός: 122
service.ath@eldico.gr
Τηλέφωνο: 6951 959708

✎ ΠΞ ΛΟΓΙΣΤΗΣ



Πάρης ΞΕΝΟΣ
Λογιστής
Εσωτερικός Αριθμός: 102
xenos@eldico.gr
Τηλέφωνο: 6949 956704

✎ ΑΚ ΓΕΝΙΚΗ ΕΠΙΣΤΑΣΙΑ



Αλέκος ΚΑΤΣΙΛΙΔΗΣ
Γενική Επιστάσια
Εσωτερικός Αριθμός: 124
Τηλέφωνο: 6946 950638

✎ ΔΜ DESIGNER ΚΑΤΑΛΟΓΟΥ



Δημήτρης ΜΑΝΔΕΛΙΑΣ
Designer Καταλόγου
Εσωτερικός Αριθμός: 119
mandelias@eldico.gr

✎ ΚΣ B2B DESIGNER



Κώστας ΣΤΑΥΡΟΠΟΥΛΟΣ
Web & Graphics Designer
Εσωτερικός Αριθμός: 103
gd@eldico.gr

✎ ΘΑ GRAPHICS DESIGNER



Θοδωρής ΑΡΑΠΗΣ
Graphics Designer
Εσωτερικός Αριθμός: 113
gd@eldico.gr

✎ ΓΑΒ R&D, GDPR, IT, ISO, ΜΚΤΑ



Γιώργος Α. ΒΕΡΑΝΗΣ
Marketing, R&D, IT, ISO
Εσωτερικός Αριθμός: 106
veranis@eldico.gr

“ Δεν θα πρέπει απλώς να ακούμε τη φωνή των πελατών μας και δεν θα πρέπει να ανταποκρινόμαστε μόνο σε αυτή, αλλά θα πρέπει να κάνουμε και το κάτι παραπάνω, που θα κάνει τους πελάτες μας πραγματικά ευτυχισμένους. ”

από την εναρκτήρια ομιλία του Γ. Μουσταφέλου για το έτος 2012

Πελατο-Μανία!

ΕΤΟΙΜΟΙ ΝΑ ΣΑΣ
ΕΞΥΠΗΡΕ-
ΤΗΣΟΥΜΕ

Νέα ριζική αλλαγή στον τρόπο που προσεγγίζουμε την συνεργασία μας με τους πελάτες μας Σύμβουλος Αγορών & "Πελατομανία"

Μέσα σε αυτά τα πλαίσια, σας παραδίνουμε το νέο ανανεωμένο μας κατάλογο που έχει φτιαχτεί πάνω σε μια διαφορετική φιλοσοφία. Αυτός ο κατάλογος φιλοδοξεί, κάποτε, να γίνει ένας πλήρης και σωστός **Σύμβουλος Αγορών**. Ο κύριος σκοπός του είναι να σας δίνει συμβουλές που αφορούν τις αγορές σας και τις πωλήσεις, και να βοηθά με τον τρόπο του στη δημιουργία για εσάς νέων ευκαιριών για αύξηση πωλήσεων. Οι απαντήσεις στις απορίες σας, καθώς και οι συμβουλές στην επιλογή των αγορών σας, θα ενσωματώνονται στις νέες βελτιωμένες εκδόσεις.

Οι Πελάτες μας στο Επίκεντρο της Προσοχής μας

Στην κορυφή της εταιρείας μας δεν είναι η διοίκηση αλλά οι **Πελάτες μας**. Το πραγματικό "αφεντικό"! Οι **Πελάτες** μας είναι αυτοί, που η συνεχής υποστήριξή τους εξασφαλίζει το παρόν και το μέλλον μας. Αντιλαμβανόμαστε πλήρως την ευθύνη μας σε όλους εσάς που μας **τιμήσατε με την επιλογή σας** και σας διαβεβαιώνουμε ότι θα κάνουμε τα πάντα για να ανταποκριθούμε σε αυτή την ευθύνη. Σαν αναγνώριση της υποστήριξής σας όλα αυτά τα χρόνια, με τον σημερινό **Κατάλογο - Σύμβουλο Αγορών** σας δίνουμε τη θέση που σας αξίζει και δεν είναι άλλη από την κορυφή της διοικητικής μας Πυραμίδας. Δεν είναι τυχαίο ότι δεύτεροι στη **Διοικητική Πυραμίδα** είναι οι εσωτερικοί μας πωλητές, είναι οι άνθρωποί μας που έρχονται σε καθημερινή επαφή μαζί σας. Κάνουμε τα πάντα και τους παρέχουμε ότι είναι δυνατόν ώστε να σας προσφέρουν κορυφαίες υπηρεσίες που αξίζετε.

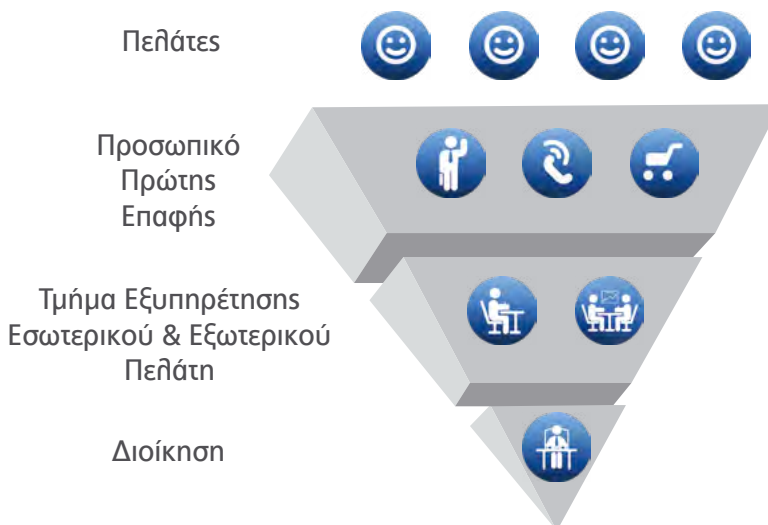

Η οικογένεια της **ΕΛΔΙΚΟ ΣΠΟΡ ΜΟΝ. Α.Ε.Ε.**, παρότι μεγάλωσε αρκετά τα τελευταία χρόνια, εξακολουθεί να μην συγκαταλέγεται στις απρόσωπες εταιρείες. Και είμαστε υπερήφανοι γι' αυτό! Είναι συνειδητή επιλογή μας να σας παρουσιάζουμε κάθε χρόνο τα πρόσωπα των συναδέλφων - συνεργατών που είναι έτοιμα και εκπαιδευμένα να σας προσφέρουν την καλύτερη δυνατή εξυπηρέτηση.

Περνώντας και το τεσσαρακοστό έτος της λειτουργίας μας συνεχίζουμε να μαθαίνουμε και να επενδύουμε συνεχώς.



Ευχόμαστε υγεία και καλές δουλειές
Με εκτίμηση,
Γ. ΜΟΥΣΤΑΦΕΛΟΣ



AMILA impulse ReNegaDE SPIRIT SOLE TOTALGYM BODYCRAFT MIKASA FOX40 SUNFLEX Butterfly STAG

ΣΥΝΟΠΤΙΚΟΣ ΚΑΤΑΛΟΓΟΣ ΕΠΙΚΟΙΝΩΝΙΑΣ ΕΛΔΙΚΟ ΣΠΟΡ ΜΟΝ. ΑΕΕ

ΑΘΗΝΑ

210 34 78 279

ΟΝΟΜΑΤΕΠΩΝΥΜΟ	ΕΣΩΤ.	ΚΙΝ. ΤΗΛ/ΝΟ	eMAIL	SKYPE NAME
---------------	-------	-------------	-------	------------

ΔΙΟΙΚΗΣΗ

Γιώργος Μουσταφέλος	155	—	gm@eldico.gr	georgemoustafelos
Ειρήνη Μουσταφέλου	101	—	me@eldico.gr	irene.moustafelou
Διονύσιος Μουσταφέλος	100	—	dm@eldico.gr	live:dionisaras13

ΣΥΜΒΟΥΛΟΙ ΑΓΟΡΩΝ

Γιώργος Λαντζάκης	110	6948 208 581	geolan@eldico.gr	george.lantzakis1
Γιώργος Ντάνασης	105	6951 953 364	gdan@eldico.gr	Γιώργος Ντάνασης
Θεόδωρος Ρόκας	111	6945 558 854	rokas@eldico.gr	rokas.eldico

ΤΗΛΕΦΩΝΙΚΗ ΕΞΥΠΗΡΕΤΗΣΗ

Κώστας Φραγκούλης	112	6946 904 595	fragoulis@eldico.gr	kos.fragoulis
Ιωάννα Κάσσαρη	104	—	joanna@eldico.gr	live:joanna.kassari

ΕΙΣΑΓΩΓΕΣ

Νίκος Δουλουγέρης	107	—	imports@eldico.gr	ndoulougeris
Μιχάλης Παπαϊωάννου	125	—	buyer@eldico.gr	live:.cid.64aa5b5df2e8ac1b

ΑΠΟΘΗΚΗ

Δημήτρης Παντελίδης	114	6955 584 472	—	—
Νίκος Θωμάϊδης	114	—	nth@eldico.gr	nth.eldico
Άγης Καφρίτσας	114	—	—	—
Αλέκος Κατσιλίδης	124	6946 950 638	—	—

ΜΕΤΑΦΟΡΕΣ

Θαδωρή Κανδηλιώτης	124	6959 997 120	—	—
Γιάννης Μαγγίνας	124	6945 934 803	—	—
Κώστας Καρίτζης	124	—	—	—

ΤΕΧΝΙΚΗ ΥΠΟΣΤΗΡΙΞΗ

Αυγέρης Αυγερινός	122	6946 904 598	service.ath@eldico.gr	—
Πέτρος Γρηγοριάδης	122	6951 959 708	service.ath@eldico.gr	—

ΟΝΟΜΑΤΕΠΩΝΥΜΟ	ΕΣΩΤ.	ΚΙΝ. ΤΗΛ/ΝΟ	eMAIL	SKYPE NAME
ΛΟΓΙΣΤΗΡΙΟ				
Πάρης Ξένος	102	6949 956 704	xenos@eldico.gr	—

ΚΑΤΑΛΟΓΟΙ, ΗΛΕΚΤΡΟΝΙΚΕΣ ΣΕΛΙΔΕΣ

Δημήτρης Μανδελιάς	119	—	mandelias@eldico.gr	mandelias
Κώστας Σταυρόπουλος	103	—	gd@eldico.gr	live:fb11e1e3d478a5af
Θοδωρής Αράπης	113	—	gd@eldico.gr	live:.cid.8c174d92813f9be3

R&D, GDPR, IT, ISO, MARKETING

Γιώργος Α. Βεράνης	106	6942 260 670	veranis@eldico.gr	georgeveranis
--------------------	-----	--------------	-------------------	---------------

ΘΕΣΣΑΛΟΝΙΚΗ 2310 57 00 37

ΟΝΟΜΑΤΕΠΩΝΥΜΟ	ΕΣΩΤ.	ΚΙΝ. ΤΗΛ/ΝΟ	eMAIL	SKYPE NAME
ΣΥΜΒΟΥΛΟΙ ΑΓΟΡΩΝ				
Γιάννης Βαφειάδης	207	6974 142 224	vi@eldico.gr	john_vafiadis

ΤΗΛΕΦΩΝΙΚΗ ΕΞΥΠΗΡΕΤΗΣΗ

Χρήστος Γκογκάκης	208	6945 896 511	cg@eldico.gr	live:cg_1290
Μανώλης Σουρής	209	—	sales.the@eldico.gr	eldico.sales.the

ΑΠΟΘΗΚΗ

Λευτέρης Τσάμπουρας	210	6955 440 986	—	—
Γιάννης Τσιφτσής	210	—	—	—
Χαράλαμπος Κεσκινιδής	210	—	—	—
Μαρία Δελή	210	—	—	—

ΜΕΤΑΦΟΡΕΣ

Χρήστος Τζίμας	210	6956 036 266	—	—
----------------	-----	--------------	---	---

ΜΕΤΑΦΟΡΕΣ / ΤΕΧΝΙΚΗ ΥΠΟΣΤΗΡΙΞΗ

Βασίλης Χατζικαμάρης	215	6943 076 045	service.the@eldico.gr	eldico.service.the
----------------------	-----	--------------	-----------------------	--------------------

1978

Ιδρύεται, από τους Χ. Μουσταφέηλο και Μ. Πινακουλάκη, η ELDICO ΕΠΕ ως πρώτη εταιρεία χονδρικής πώλησης ειδών camping με έδρα το Νέο Ψυχικό. Τα αρχικά της είναι παράγωγα των λέξεων hEllenic DIstribution COmpany.



1989

Έτος ορόσημο για την ΕΛΔΙΚΟ. Μετακομίζει σε νέες μεγάλες αποθήκες 3.800m² στο Βοτανικό. Στο σημείο που βρίσκεται ως σήμερα.



1995

Δεύτερο έτος ορόσημο, κατά το οποίο το κτήριο περνά στην ιδιοκτησία της εταιρείας, ενώ παράλληλα η οικογένεια Μουσταφέηλου αγοράζει το μερίδιο του κ. Πινακουλάκη.

2000

Εισάγονται για πρώτη φορά έπιπλα εξωτερικού χώρου. Η εταιρεία αρχίζει να επενδύει σε ανθρώπινο δυναμικό, πληροφορικά συστήματα και εκσυγχρονισμό των εγκαταστάσεων.



2008

Αλλάζει το λογιστικό και εμπορικό πρόγραμμα της εταιρείας σε ERP. Η εξυπηρέτηση και η παραγγελιοληψία γίνονται ακόμα πιο ευέλικτες. Παράλληλα αλλάζει και η οργανωτική δομή της ΕΛΔΙΚΟ ΣΠΟΡ ΑΕΕ.

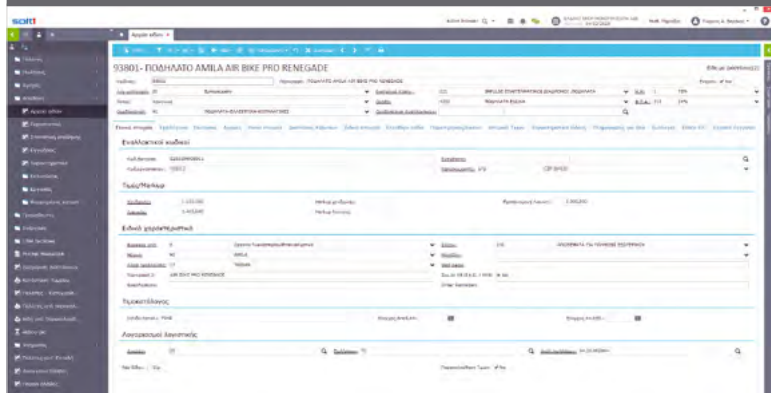

45 Χρόνια Ιστορίας

Η ΕΛΔΙΚΟ ΣΠΟΡ ΜΟΝ. ΑΕΕ στο πέρασμα του χρόνου



1981

Η εταιρεία μεταφέρεται στα νέα μεγάλα γραφεία στους Αμπελόκηπους με τα νέα της ονόματα: NEW ELDICO ΕΠΕ & ELDICO CAMPING.



1990

Η γκάμα των προϊόντων μεγαλώνει σημαντικά. Προστίθενται αθλητικά και είδη θαλάσσης, παίρνοντας, πλέον, την ονομασία ΕΛΔΙΚΟ ΣΠΟΡ ΑΕΕ.



1998

Μια πολύ σημαντική στρατηγική πολιτική της εταιρείας πραγματοποιείται. Η ΕΛΔΙΚΟ ΣΠΟΡ ΑΕΕ εισέρχεται στον χώρο των οργάνων γυμναστικής.



2007

Εκπληρώνεται ένα μεγάλο όνειρο. Η ΕΛΔΙΚΟ ΣΠΟΡ ΑΕΕ επενδύει στη βόρεια Ελλάδα κατασκευάζοντας ένα κτήριο 3.200m² στην περιοχή της Σίνδου Θεσσαλονίκης. Οι ακόμα πιο έγκαιρες και οικονομικότερες αποστολές γίνονται πραγματικότητα.



2012

Πραγματοποιούνται νέες μεγάλες επενδύσεις σε στόλο και εξοπλισμό. Δημιουργείται το eldico-ric.gr για την άμεση αποστολή φωτογραφιών και προσπέκτους.

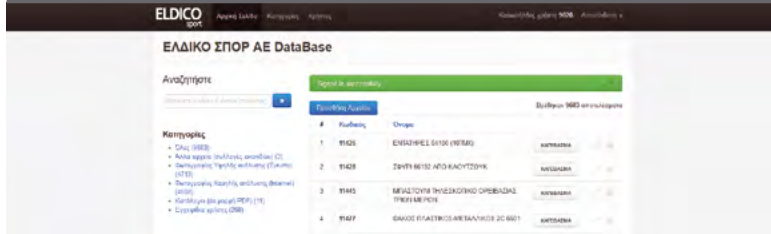

2019

Νέα επέκταση αποθηκευτικού χώρου στις εγκαταστάσεις της Θεσσαλονίκης δημιουργεί διαθέσιμο 4.000m², αυξάνοντας τον συνολικό αποθηκευτικό χώρο της εταιρίας πλέον των 8.000m².

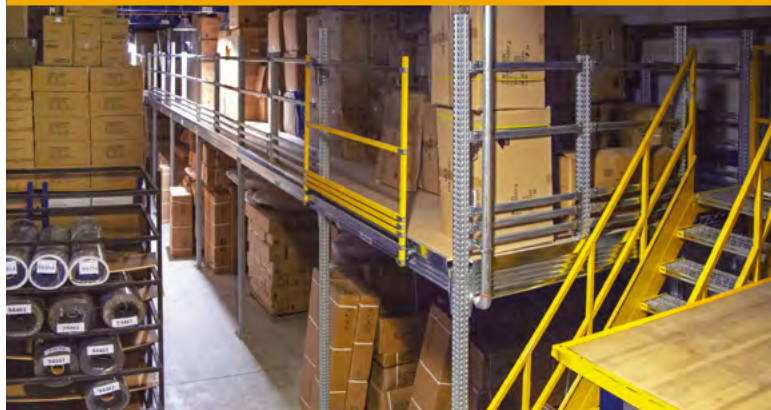

2011

Η ΕΛΔΙΚΟ ΣΠΟΡ ΑΕΕ πιστοποιεί την ποιότητα των υπηρεσιών της, προσθέτοντας στα ήδη υπάρχοντα συμφωνητικά με την Ελληνική Εταιρεία Αξιοποίησης Ανακύκλωσης ΑΕ και την εταιρία Ανακύκλωσης Συσκευών ΑΕ, το Πρότυπο ISO 9001:2000.

2013

Δημιουργείται ο δικτυακός χώρος B2B που δίνει OnLine πληροφόρηση σε όλους τους συνεργάτες.

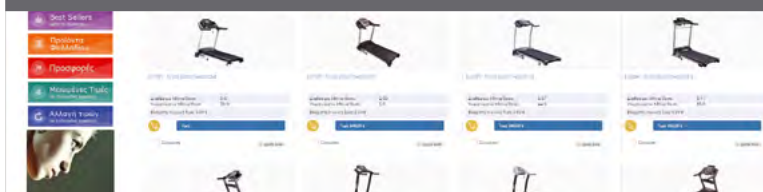

2020

Η εταιρία μετονομάζεται. Η νέα της επωνυμία είναι ΕΛΔΙΚΟ ΣΠΟΡ ΜΟΝΟΠΡΟΣΩΠΗ Α.Ε.Ε. Η οροφή του κεντρικού κτηρίου οικοδομείται, προσφέροντας επιπλέον προστασία στα προϊόντα. Παράλληλα διαμορφώνονται νέοι λειτουργικοί χώροι έκθεσης και συνομιλίας.



eldico-b2b.gr Η νέα on-line εποχή έφτασε!

Δεν πρόκειται για μια απλή on-line υπηρεσία. Η νέα πλατφόρμα της ΕΛΔΙΚΟ ΣΠΟΡ ΜΟΝ. ΑΕΕ σχεδιάστηκε από την αρχή, όχι για να προστεθεί απλά στις υπάρχουσες δομές αλλά για να αλλάξει εξολοκλήρου τον τρόπο με τον οποίο γινόντουσαν όλες οι ηλεκτρονικές συναλλαγές μέχρι σήμερα.

STAY TUNED!

Το 2020 ήταν η χρονιά μετάβασης στις νέες on-line B2B υπηρεσίες μας. Μια μόνο πλατφόρμα ενοποιεί πλέον στιδήποτε μέχρι σήμερα υπάρχει σε ξεχωριστές σελίδες, σχεδιασμένη για να εξυπηρετεί κάθε ανάγκη με τον πιο λειτουργικό τρόπο. Μείνετε όμως συντονισμένοι: Η νέα B2C σελίδα καταφθάνει κι αυτή!



eldico-b2b.gr

Το 2013 δημιουργήσαμε την πρωτοποριακή διαδικτυακή υπηρεσία B2B (Business to Business) η οποία είναι συνδεδεμένη on-line με το εμπορικό πρόγραμμα της επιχείρησης προσφέροντας έγκυρη, άμεση και γρήγορη πληροφόρηση οποιαδήποτε στιγμή κι αν την χρειαστεί ο χρήστης.



Η πλατφόρμα B2B της ΕΛΔΙΚΟ έχει σχεδιαστεί έχοντας κατά νου τον πελάτη και τις σύγχρονες ανάγκες του.

Μέσα από την πλατφόρμα B2B ο χρήστης μπορεί να δει τα προϊόντα της ΕΛΔΙΚΟ, να ενημερωθεί για ό,τι νέο υπάρχει και όλα όσα αναμένονται σύντομα. Ταυτόχρονα υπάρχει η δυνατότητα να

ελέγξει **Best Sellers, Προϊόντα Φυλλιαδίου** με όσα περιέχονται στα τρέχοντα προωθητικά έντυπα που εκδίδονται από την εταιρεία. Στο B2B, επίσης, βρίσκονται διαθέσιμες οι **Προσφορές, τα Προϊόντα με Μειωμένες Τιμές και καρτέλες που περιέχουν είδη με μεταβλητή τιμή.** Η πλατφόρμα B2B είναι ένα «ζωντανό» cloud application το οποίο αναβαθμίζεται

και γίνεται καλύτερο μέρα με τη μέρα. Αυτό επιτυγχάνεται ακόμα γρηγορότερα εαν εσείς, οι συνεργάτες μας, μας στέλνετε feedback με απορίες, προτάσεις και παρατηρήσεις.



on-line οδηγός χρήσης:
eldico-b2b.gr/content/18-usage_manual

XML

Οι σύγχρονες ανάγκες για ακόμα πιο γρήγορη καταχώρηση δεδομένων, αλλά και για άμεση και αδιάκοπη ενημέρωση τιμών, διαθεσιμότητας (στις 2 αποθήκες ξεχωριστά), φωτογραφιών και 22 ακόμα στοιχείων, δημιούργησε την υπηρεσία XML.

Μην παραλείψετε να συγχρονίσετε το XML της ΕΛΔΙΚΟ ΣΠΟΡ ΜΟΝ. ΑΕΕ με το e-shop σας, για να έχετε την ταχύτερη και πιο έγκυρη πληροφόρηση όλων όσων σας ενδιαφέρουν. Το XML είναι πολύτιμος συνεργάτης και για όσους δεν διαθέτουν ηλεκτρονικό κατάστημα (e-shop). Οι πληροφορίες του μπορούν να σας χρησιμεύσουν σχεδόν σε όλες τις συναλλαγές σας. Απευθυνθείτε στον σύμβουλο αγορών που σας εξυπηρετεί και ζητήστε του το XML link σας.

Δείτε ένα σύντομο οδηγό της on-line υπηρεσίας στη διεύθυνση: eldico.gr/xml

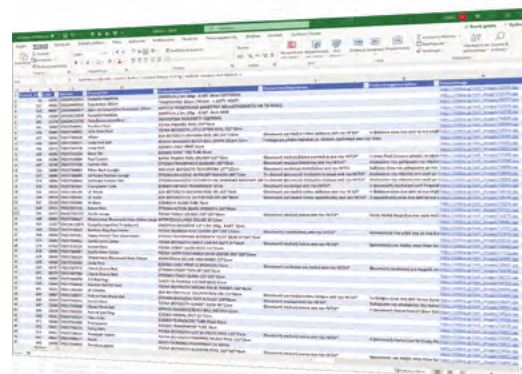

AMILA.GR

OnLine Υπηρεσίες

XML: Το 2017 προσθέσαμε, στις ήδη υπάρχουσες ηλεκτρονικές υπηρεσίες (B2B, eldico-pic.gr, dropbox.k.ln), τη λίστα XML κάνοντας ακόμα πιο εύκολη την καταχώρηση δεδομένων.

eldico.gr: Σκοπός του ολοκαίνουριου κεντρικού site είναι η **σταδιακή ενοποίηση όλων των on-line υπηρεσιών** που σας παρέχουμε (καταλόγους, οδηγίων χρήσης, εικόνων, xml), έτσι ώστε να γίνει πιο φιλική η χρήση τους. Επιπλέον να προωθηθούν και κεντρικά (κοινωνικά δίκτυα, έντυπο και ηλεκτρονικό τύπο) τα προϊόντα που προσφέρετε και, έτσι, να διευκολύνουν τις πωλήσεις σας.

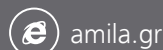



Κατάλογοι, προϊόντα, ενημερωμένες πληροφορίες και τιμές, απ' όπου κι αν βρίσκεστε, άμεσα κι απλά.

Dropbox: Η νέα μας on-line υπηρεσία ενημέρωσης

Η ΕΛΔΙΚΟ ΣΠΟΡ ΜΟΝ. ΑΕΕ στην προσπάθειά της να γίνει όσο το δυνατόν πιο φιλική και άμεση στις ανάγκες σας, εισήγαγε την υπηρεσία Dropbox στις on-line παροχές της, προσφέροντας κάθε στιγμή, όπου κι αν βρίσκεστε, **την πιο ενημερωμένη έκδοση των καταλόγων της**.

Έτσι, όταν χρειάζεται να ανατρέξετε σε προϊόντα και τιμές, με το Dropbox μπορείτε να έχετε έγκυρη πληροφόρηση, από τον υπολογιστή ή το κινητό σας, **με ένα μόνο click**.

Τι είναι το Dropbox;

Το Dropbox είναι μια δωρεάν on-line υπηρεσία αποθηκευτικού χώρου που επιτρέπει την κοινή χρήση αρχείων μεταξύ διαφορετικών συσκευών και χρηστών. Με απλά λόγια είναι **ένας σκληρός δίσκος στο internet**.

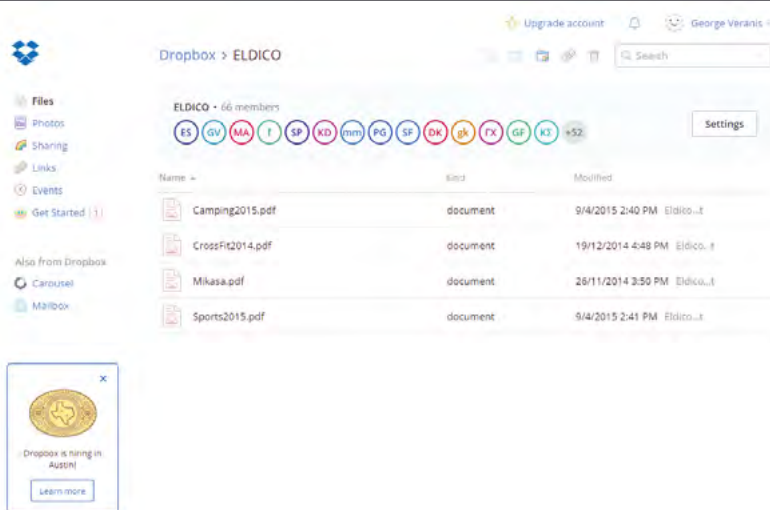

Γιατί όμως να χρησιμοποιήσω το Dropbox;

Ο κυριότερος λόγος είναι η **αμεσότητα**. Ενημερώνεται αυτόματα και προσφέρει, όποτε το χρειαστείτε, πολύ γρήγορα, με ελάχιστες απαιτήσεις, σε οποιαδήποτε συσκευή σας, **την πιο ενημερωμένη έκδοση όλων των καταλόγων μας**.

Φανταστείτε ότι βρίσκεστε στο κατάστημα σας και δεν μπορείτε να βρείτε που έχετε αφήσει τον κατάλογο της ΕΛΔΙΚΟ ΣΠΟΡ ΜΟΝ. ΑΕΕ ή σε κάποιο ραντεβού για δειγματισμό ή ακόμα και στον δρόμο ή το σπίτι και θέλετε να σημειώσετε κάποια από τα προϊόντα ή να ελέγξετε την τρέχουσα τιμή τους.

Χωρίς να χρειάζεται να κάνετε κάποια άλλη ενέργεια, ανοίγοντας απλά τον υπολογιστή ή το κινητό σας, έχετε τα ίδια ακριβώς αρχεία με αυτά που έχουμε κι εμείς.

Εγκαταστήστε τώρα την υπηρεσία Dropbox και μείνετε ενημερωμένοι για πάντα.

Επικοινωνήστε με την ΕΛΔΙΚΟ ΣΠΟΡ ΜΟΝΟΠΡΟΣΩΠΗ ΑΕΕ και ένας συνεργάτης μας θα βρίσκεται πάντοτε διαθέσιμος για να σας βοηθήσει στην δημιουργία του λογαριασμού σας, με απλές οδηγίες και επεξηγηματικά videos.

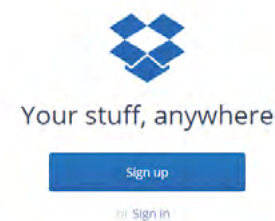
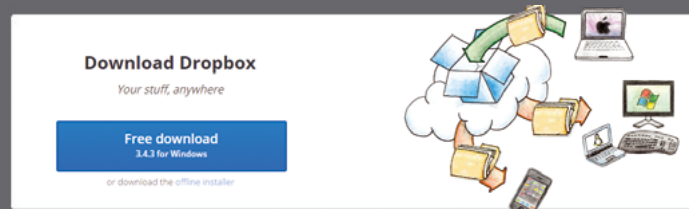

username



password

Συμβατότητα

Είναι συμβατό με υπολογιστές που χρησιμοποιούν windows, linux ή και MAC, με κινητά τηλέφωνα iPhone, Android, BlackBerry και ταμπλέτες.

Εκμεταλλευτείτε τις δυνατότητες του solefitness.gr και βοηθήστε τους πελάτες σας να δουν όλα τα προϊόντα SOLE και να λύσουν τις απορίες τους.



▲ ανακαλύψτε τα προϊόντα της SOLE μέσα από τα videos στο solefitness.gr/support

Σκοπός του solefitness.gr είναι να βοηθήσει στην κατά το δυνατόν μεγαλύτερη και πιο αναλυτική εξερεύνηση των εξαιρετικών Ποδημάτων και Ελληπτικών της SOLE και των δυνατοτήτων που παρέχουν στους χρήστες τους.

Η σελίδα χωρίζεται σε πέντε (5) βασικά μέρη πλοήγησης:

- α Σχετικά με τη SOLE**
Σύντομη παρουσίαση της εταιρίας SOLE Fitness.
- β Προϊόντα**
Επιλέγοντας "Διάδρομοι" ή "Ελληπτικά" ανακαλύψτε κάθε πτυχή των κορυφαίων οργάνων της SOLE.
- γ SOLE Fitness App**
Μάθε τις απεριόριστες δυνατότητες που σου προσφέρονται συνδέοντας την iOS ή Android συσκευή σου στον αγαπημένο σου SOLE.
- δ Υποστήριξη**
Αναλυτικά videos παρουσιάσεων και εγχειριδίων χρήσης για όλα τα προϊόντα SOLE Fitness.
- ε Συνεργάτες**
Το Δίκτυο Συνεργατών αποτελεί το σημαντικότερο κρίκο μιας άψογης εμπειρίας.

SOLE

Δημιουργούμε τα κατάλληλα εργαλεία για την προώθηση των πωλήσεών σας.



Εγχειρίδια Χρήσης

Δεν χρειάζεται να ψάχνεις. Όλα τα εγχειρίδια χρήσης των διαδρόμων και των ελληπτικών της SOLE Fitness βρίσκονται πλέον συγκεντρωμένα και διαθέσιμα όποτε κι αν τα χρειαστείς.

Τιμές Λιανικής

Στην αρχή κάθε παρουσί-σας αναγράφεται η προτεινόμενη λιανική τιμή.

footer

◀ Μην ξεχάσεις να ρίξεις μια ματιά στα χαρακτηριστικά!



Αναγνωρισιμότητα, Ανταπόκριση, Παρουσίαση, Προώθηση, Πώληση!

Ψηφιακό Κανάλι: eldico.gr/youtube

Η ΕΛΔΙΚΟ ΣΠΟΡ ΜΟΝ. ΑΕΕ ανταποκρινόμενη στις συνεχώς αυξανόμενες ανάγκες ενός σύγχρονου επιχειρηματικού περιβάλλοντος, βελτιώνει διαρκώς τις υπηρεσίες της, εκπέμποντας μέσα από το δικό της **κανάλι** στο eldico.gr/youtube

Αυξήστε τις πωλήσεις σας με Video Marketing

Το YouTube δημιουργήθηκε το 2005. Ένα μόλις χρόνο μετά ονομάστηκε "η εφεύρεση της χρονιάς" από το περιοδικό Times. Σύμφωνα με την Έρευνα Κοινωνικής Δικτύωσης 2013-14 του Οικονομικού Πανεπιστημίου Αθηνών και του ELTRUN το **YouTube είναι πρώτο από όλα τα Social Media. Οι επιχειρήσεις βρίσκουν συνεχώς ολοένα και περισσότερους τρόπους για να χρησιμοποιήσουν τα videos ώστε να προσεγγίσουν τους πελάτες τους.**



Το Video Marketing με αριθμούς

Σύμφωνα με έρευνα του Ascend2 (Research-Based Marketing) για το 2015, **τα videos αυξάνουν:**
κατά 47% την αναγνωρισιμότητα (brand awareness)
κατά 45% τη αλληλεπίδραση των ακολούθων σας (engagement)
κατά 43% την ενημέρωση των πελατών
κατά 41% τις ενέργειες
κατά 34% το ποσοστό ανταπόκρισης (conversion rate)
κατά 26% τα έσοδα από πωλήσεις

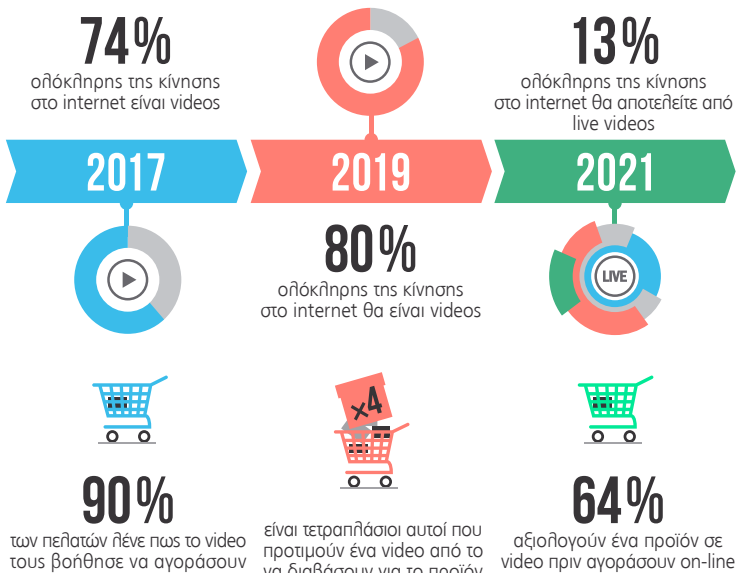
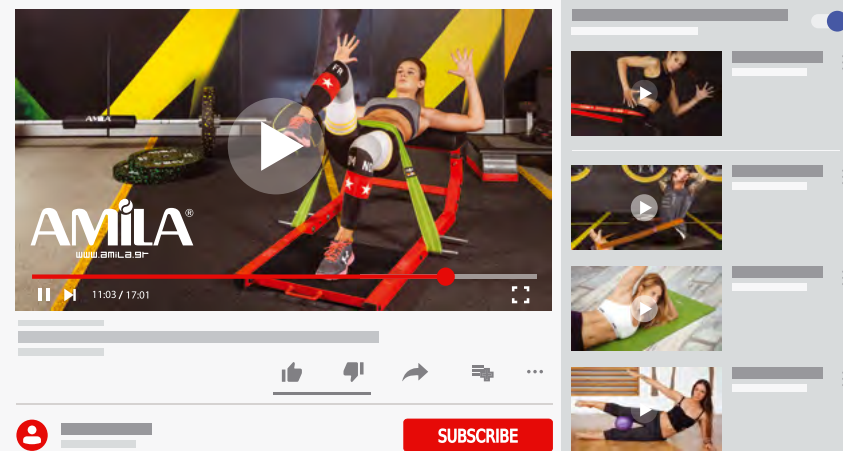

Για να **μπείτε** στο κανάλι της ΕΛΔΙΚΟ ΣΠΟΡ ΜΟΝ. ΑΕΕ, πληκτρολογήστε στη γραμμή διεύθυνσεων: eldico.gr/youtube

Για να διαλέξετε **συγκεκριμένο φάκελο με videos** επιλέξτε από το menu το "PLAYLISTS".

Μην ξεχάσεις να κάνεις **SUBSCRIBE (ΕΓΓΡΑΦΗ)** στο κανάλι **ELDICO SPORT SA** για να μαθαίνεις πρώτος τα νέα videos και να τα προωθείς, μέσω των δικών σου καναλιών ή του eShop σου, **αυξάνοντας τις πωλήσεις σου!**

Τι περιμένεις; Ξεκίνησε Τώρα!

Το 85% των εταιρειών δηλώνει ότι το video marketing είχε επιτυχία για την επιχείρησή τους.

Εμπλουτίστε τη σελίδα ή το eShop σας με τα videos από το κανάλι της ΕΛΔΙΚΟ και βοηθήστε τις πωλήσεις σας όσο τίποτε.

eldico.gr/youtube



Διάδρομος

Όλα όσα θα πρέπει να ξέρεις για τον κατασκευαστή και την χώρα παραγωγής

Ένας από τους πλέον σημαντικούς παράγοντες για την ποιότητα ενός διαδρόμου είναι ο κατασκευαστής [εργοστάσιο κατασκευής] αλλά και η χώρα κατασκευής.

Το μεγαλύτερο ποσοστό των διαδρόμων κατασκευάζεται σε δυο χώρες: την Ταϊβάν και την Κίνα.

Τα εργοστάσια κατασκευής χωρίζονται σε τέσσερις [4] κύριες κατηγορίες, με την ακόλουθη κατάταξη ως προς την ποιότητα κατασκευής:

1. Εργοστάσια στην Ταϊβάν.
2. Ταϊβανέζοι κατασκευαστές με εργοστάσιο συναρμολόγησης στην Κίνα.
3. Μεγάλοι Κινέζοι κατασκευαστές με εμπειρία και συνεργασία με μεγάλους οίκους.
4. Λοιποί Κινέζοι κατασκευαστές.

Treadmill Doctor
The Most Trusted Name In
Fitness Equipment

Οι διάδρομοι της **AMILA** κατασκευάζονται σε 3 Ταϊβανέζικα εργοστάσια που παράγουν για μεγάλους και επώνυμους οίκους της Αμερικής και της Ευρώπης, των οποίων τα προϊόντα είναι ανάμεσα στις καλύτερες επιλογές, σύμφωνα με τις λίστες Αμερικανικών οίκων αξιολόγησης (Dr. Treadmill κλπ).

Ορισμένοι ενδιάμεσοι διάδρομοι AMILA και όλοι οι οικονομικοί, κατασκευάζονται στα εργοστάσια των Ταϊβανέζων κατασκευαστών που βρίσκονται στην Κίνα.

Η **ΕΛΛΗΚΟ ΣΠΟΡ ΑΕ** πιστεύει ότι παρόλο που οι Κινέζοι κατασκευαστές έχουν βελτιωθεί τα τελευταία χρόνια, ωστόσο εξακολουθούν τα προϊόντα και οι υπηρεσίες τους να υπολείπονται σημαντικά από αυτά των Ταϊβανέζων κατασκευαστών.

Πόση σημασία έχει η ιπποδύναμη του μοτέρ σε ένα διάδρομο;

Το κόστος ενός μοτέρ μεγαλύτερης ιπποδύναμης είναι συγκριτικά μικρό ενώ το κόστος του επιπλέον βάρους, της βελτίωσης στην ακαμψία του διαδρόμου και της μεγαλύτερης άνεσης είναι πολλαπλάσιο.

Το κόστος για τον κατασκευαστή προκύπτει από τη διαπλάτυνση και το βάρος του διαδρόμου, και όχι από την ιπποδύναμη.

Μεγαλώνοντας το πλάτος ενός διαδρόμου, μεγαλώνει αναλογικά το μήκος, ο ιμάντας, τα ρουλά και μεγαλώνει η κοσδόλα που πλέον έχει πολύ περισσότερες λειτουργίες.

Ποια η διαφορά των μοτέρ AC με τα DC;

Η διαφορά βρίσκεται στην πηγή τροφοδοσίας τους.

Τα μοτέρ AC τροφοδοτούνται με εναλλασσόμενο ρεύμα που ελέγχεται από ηλεκτρονικό κύκλωμα και πρόγραμμα (inverter).

Τα μοτέρ DC τροφοδοτούνται με συνεχές ρεύμα ελεγχόμενο από ένα ηλεκτρονικό κύκλωμα μετατροπής του εναλλασσόμενου ρεύματος σε συνεχές.

Τα μοτέρ AC είναι πιο δυνατά, έχουν πολύ μεγαλύτερη διάρκεια ζωής και θέλουν πολύ λιγότερη συντήρηση, είναι όμως πιο ακριβά και σε συνδυασμό με τον inverter που χρησιμοποιούν το κόστος τους είναι αυξημένο.



Ιμάντας Τρεξίματος Το μέγεθος μετράει!

Στην Αμερική αλλά και στην Ευρώπη οι διάδρομοι πουλιούνται πλέον ΟΧΙ με βάση την Ιπποδύναμη του μοτέρ, αλλά με βάση την διάσταση του ιμάντα τρεξίματος.

Μέτρηση Ιπποδύναμης

Το μοτέρ είναι αρκετά σημαντικός παράγοντας, οφείλουμε όμως να είμαστε προσεκτικοί. Υπάρχει πολύ παραπληροφόρηση όσο αφορά την ιπποδύναμη του.

Λόγω της ιδιαιτερότητας του διαδρόμου (απαιτεί από το μοτέρ πλήρη ισχύ μόνο για ορισμένα

μόνο κλάσματα του δευτερολέπτου) η ιπποδύναμη μετριέται με πολλούς τρόπους. Έτσι έχουμε δύο τύπους ιπποδύναμης, την συνεχή και την στιγμιαία αποδιδόμενη.

Πολλοί κατασκευαστές, εκμεταλλεύονται αυτή τη σύγχυση, αναφέρουν σκόπιμα μόνο τη μέγιστη στιγμιαία ισχύ,

Ιπποδύναμη και Ιμάντας

Στο εμπρός μέρος του διαδρόμου βρίσκεται το μοτέρ, ο μηχανισμός ανύψωσης και ο ελεγκτής (controller).

Ο χώρος, πολλές φορές είναι δεσμευτικός του μεγέθους του μοτέρ. Για ένα μοτέρ 2Hp το ελάχιστο πλάτος του ιμάντα είναι 45cm. Εάν ο ιμάντας είναι στενότερος των 45cm, το πιο πιθανόν είναι η ιπποδύναμη του μοτέρ να είναι μικρότερη από 2Hp.

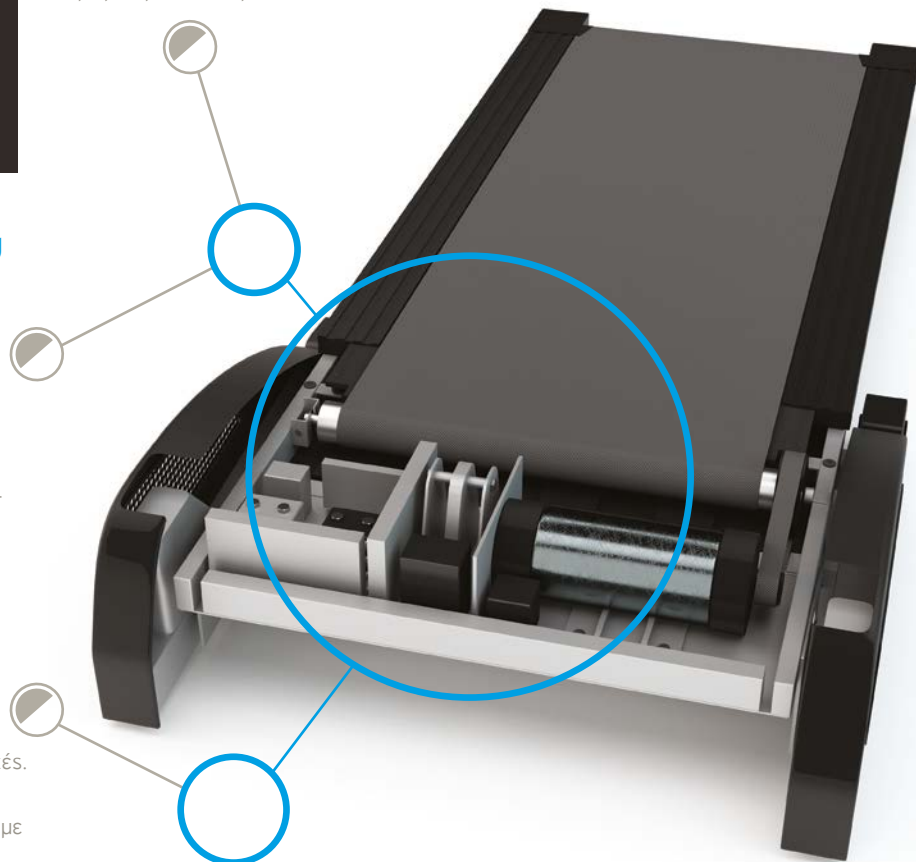

Ιμάντας Τρεξίματος

Όσο πιο παχύς είναι ο ιμάντας τόσο πιο ανθεκτικός και άνετος (αντικραδασμικός) γίνεται

Τα συνήθη πάχη του είναι: 1.6 -2.5mm και 3.0mm ο ορθοπεδικός.

Όλοι οι ιμάντες της AMILA, παρέχουν αντιστατική προστασία, και διοχετεύουν το στατικό ηλεκτρισμό στην γείωση, ώστε να προστατεύονται τα ηλεκτρονικά μέρη του διαδρόμου.

Τελευταία οι εταιρείες αυξάνουν τον ιμάντα τρεξίματος με πλασματικό τρόπο χωρίς να αυξήσουν το πλάτος του διαδρόμου. Η αύξηση αυτή γίνεται καταλαμβάνοντας το κενό που υπήρχε παλαιότερα μεταξύ του ιμάντα και των πλαϊνών κουπαστών.

Έτσι ένας ιμάντας που παλαιότερα ήταν 43cm, τώρα μπορεί να φτάσει τα 45cm μειώνοντας μόνο τα κενά.

Κύλινδροι

Όσο μεγαλύτεροι είναι οι κύλινδροι τόσο περισσότερο βοηθούν το μοτέρ να ανταποκριθεί στις καταπονήσεις. Το μέγεθος των κυλίνδρων ποικίλει. Μπορούμε να τους συναντήσουμε από 48 μέχρι 100mm.

Κυλίνδρους 48mm βρίσκουμε σε μικρούς διαδρόμους 1.25-1.50hr ενώ των 60mm συναντούμε συνήθως σε μοτέρ 2.5hr και άνω.

Το μέγεθος των 100mm χρησιμοποιείται για διαδρόμους επαγγελματικής χρήσης.

Δάπεδο διαδρόμου

Εξίσου σημαντικός ποιοτικός παράγων είναι ο κατάλληλος συνδυασμός δαπέδου, και ιμάντα τρεξίματος, ώστε να έχουμε μικρότερη τριβή, μικρότερη θερμοκρασία, και μικρότερη καταπόνηση του μοτέρ.



Κονσόλα

Τα κύρια σημεία που πρέπει να ελέγξουμε σε μια κονσόλα είναι:

- Κουμπιά κλίσης και ταχύτητας στις χειρολαβές
- Μεγάλη οθόνη πολλαπλών ενδείξεων για άμεση ενημέρωση των παραμέτρων της άσκησης
- Μπλε οθόνη για ομορφιά, αλλά και για άνετη ανάγνωση των παραμέτρων της άσκησης
- Προγράμματα. Πρακτικώς είναι το λιγότερο αναγκαίο χαρακτηριστικό.
- Δέκτη καρδιακών παλμών για να μπορεί να δεχθεί ζώνη καρδιακών παλμών.
- Χειρολαβές αισθητήρων καρδιακών παλμών με εργονομική κλίση.
- Κουπαστές από ειδικά υλικά που να μπορούν να παρέχουν προστασία.

* τέσσερις πρόχειροι και απλοί μέθοδοι σύγκρισης της ποιότητας των μοτέρ

1. : Μετρώντας το καθαρό μήκος του μοτέρ
2. : Μετρώντας το βάρος του μοτέρ
3. : Ζυγίζοντας ή ρωτώντας το καθαρό βάρος του διαδρόμου

Το σημαντικότερο στοιχείο είναι το πλάτος του ιμάντα τρεξίματος.

Ένας διάδρομος 2hr θα πρέπει να έχει τουλάχιστον 45cm ιμάντα, αναγκαία συνθήκη αλλά όχι και ικανή (θα μπορούσε δηλαδή να υπάρξει ιμάντας 50cm για παράδειγμα με μοτέρ μικρότερο των 2hr).

Βάρος διαδρόμου	Maximum βάρος αναβάτη	Ιπποδύναμη	"Min. Size ιμάντα τρεξίματος"	Βάρος Μοτέρ [Kg]	Μήκος Μοτέρ [cm]
60	90 - 100	1,25 - 1,50	40 cm	6,80	23,5
67 - 67	100	1,50 - 1,75	40 cm	7,97	21,5
75 - 78	100	1,75	42 cm	11,13	26,5
82	110	2,00	45 cm	11,80	25,0
92	120	2,00 - 2,50	48 cm	12,66	27,0
105	130	3,00	50 cm	14,05	28,5

Πίνακας βαρών και διαστάσεων μοτέρ.



Cushion Flex Whisper Deck

The deck of the **SOLE** treadmills provides a comfortable and quiet workout.

The correct combination of anti-vibration materials, deck and belt has proven according to a study to **reduce noise and foot vibration/impact by 40%** compared to running on asphalt.

Thus the user is protected in the best possible way..

SOLE
FITNESS



Easy to fold/unfold and transport

SOLE Fitness has improved the way it folds/unfolds its treadmill's deck. It will slowly unfold at the push of a switch Με το πάτημα ενός διακόπτη θα ξεδιπλωθεί αργά, without needing any help and will fold **securely** and **easily** into an upright position. The integrated wheels at the bottom makes its transport a childs play.



Treadmill Doctor
The Most Trusted Name in Fitness Equipment

Doctor Treadmill's BEST BUY

SOLE Fitness has won dozens of awards.

All its models are always in the top 3 of the most review sites.

But its biggest success is that its **F80 model, for the last 4 years, has been in the list of the 3 best treadmills in the US market** from the most prominent treadmill review website, **Doctor Treadmill**.

Out of those 4 years, for 2 in the row it was the number 1 on the list.

Its elliptical, E35, according to **Doctor Treadmill** and other review websites, is characterised as **the best elliptical in the largest and most competitive category** of a price range between \$1.000-1.300.



The irrefutable quality of **SOLE** was the reason it was **selected by HILTON to equip all of its suites and Luxury Business Rooms worldwide** with its treadmills. **SOLE** further developed its technology so that anyone (even a woman) can fold, unfold and move the treadmill, an advantage which was deemed necessary for the ease of cleaning the room. After that, **SOLE** was chosen by many more hotels πηλέχτηκε to equip their suites.

Increase your sales by integrating the SOLE Fitness videos into your eShop



Program Select Buttons

Incline Change Buttons

Audio In

Twin Turbo Fans

Speakers

Ergonomic Grips with integrated Heart Rate Sensors

Phone and Tablet stand

LCD screen

You may charge your phone or MP3 player during the workout with the integrated USB charging station.



Speed Adjust Buttons

Double Cup Holders Storage for small items

Audio Out

Safety Key

Research by the **American Society of Sports Medicine** has concluded that the placement of the Heart Rate Sensors directly affects the body posture. It is extremely important for the correct execution of the exercise that the grips are ergonomical.

Adjustable Pedals

SOLE Fitness, taking into account that not all users walk the same way, in addition to the fact that the best exercise is achieved when the sole move parallel to the ground. For these reasons, it enabled the user to adjust the incline of the pedals up to 10° degrees.



<http://solefitness.gr>

SOLE

For many years, SOLE Fitness, an American company designing and manufacturing fitness equipment, has proven to be one of the basic protagonists in the fitness equipment market, both for beginners and the very advanced users. SOLE continues unabated to design and develop fitness equipment for home and semi-commercial use for small gyms and hotels.

Electronic Incline

The electronic incline provides **extra resistance** and **variable positioning** to your workout at the touch of a button.



The incline can be adjusted from 0 to 30 degrees, allowing you to exercise all lower body muscle groups.

0-30°

Kinomap

Kinomap, the world's largest video sharing platform, provides training apps that enable runners, cyclists and rowers to train on **existing routes**. The app will change the **incline** or the **resistance** of your machine **in real time**, depending on the conditions on the route you have chosen.



SOLE Fitness APP

The **SOLE Fitness APP** connects to the treadmill, bike or elliptical by **Bluetooth**.

You may see the current exercise data on 3 distinct screens on your **Android** or **Apple** device.

Upon completion of the exercise, the data is automatically saved in your personal diary.

Available on the **Google Play**

Download on the **App Store**

2° Internal Slope

According to research, the exercise on the elliptical becomes more ergonomic (more comfortable, efficient and safer from ankle injuries) when the incline of the sole is 2° inwards, which inclination **aligns more correctly the legs to the body** and **reduces the pressure on the ankles and knees**.



Warranty & Quality

All **SOLE Fitness** products are made in a simple way, emphasising

- the high-quality materials and components,
- the perfect combination of design and technology [e.g. not only quality of materials and the combination of running belt with the deck, as well as the size and quality of

the rollers to be able to cope with the demanding hotel environment] but mainly

- at competitive—in relation to their quality— prices.

SOLE Fitness backs all its parts—electrical and mechanical—with a 2 year warranty. Specifically for the motor, the warranty is extended to 10 years.



F85 (2023)

Category D1

44821
\$ 1.590,00



F80 (2023)

Category D1

44807
\$ 1.385,00



Motor	DC 4.00 hp	3.50 hp
Console	TFT 15.6" Touchscreen with WiFi, various applications and smartphone mirroring function, Speed and Incline buttons, Heart rate sensors	TFT 10.1" Touchscreen with WiFi, various applications and smartphone mirroring function, Speed and Incline buttons, Heart rate sensors
Console Readings	Time, Distance, Heart rate, Calories, Speed, Incline, Pace, Track	Time, Distance, Heart rate, Calories, Speed, Incline, Pace, Track
Programs	7 + 2 HRC + 7 fitness tests + up to 12 user	7 + 2 HRC + 7 fitness tests + up to 12 user
Speed	1-22 Km/h	1-20 Km/h
Incline	Electronic from -6 to +15 levels	Electronic 15 levels
Deck	Cushion Flex Whisper Deck	Cushion Flex Whisper Deck
Belt	56x152,5 cm	56x152,5 cm
Rollers	—	—
Dimensions (open)	209,5x96,2x167,5cm (folded 112,0x96,1x181,5cm)	209,5x96x167,5cm (folded 112x96x181,5cm)
Weight	145Kg	124,5Kg
Max User Weight	170 Kg	160 Kg
Other Specs	Transport wheels, Bottle holders, Fans, Phone/tablet holder, Speakers via Bluetooth 3, Hydraulic unfolding, Bluetooth speaker, Bluetooth heart rate monitor, Wireless charging 10 Watts, Analog heart rate receiver, SOLE+, Kinomap, Zwift apps via Bluetooth 5, WiFi for the console apps.	Fan, Phone/tablet holder, Bottle holder, 10 watt wireless charging, Accessory tray, Speakers via Bluetooth 3, Polar, SOLE+, Kinomap, Zwift apps via Bluetooth 5, WiFi



USAGE WITH PHONE

- + Bluetooth
- + SOLE+ app.
- + Data sync with Apple Health, Google Fit, Strava, Fitbit, MapMyFitness
- + Data sharing with Facebook, Instagram, Twitter



USAGE WITH PHONE

- + Bluetooth
- + SOLE+ app.
- + Data sync with Apple Health, Google Fit, Strava, Fitbit, MapMyFitness
- + Data sharing with Facebook, Instagram, Twitter

+ Speed & Incline buttons on the hand-grips

WARRANTY
1 year for commercial use



+ Speed & Incline buttons on the hand-grips

WARRANTY
1 year for commercial use



F65 (2023)

Category D1

44806

\$ 1.035,00



F63 (2023)

Category D1

44805

\$ 812,00



Motor	3.00 hp	3.00 hp
Console	LCD 9", Speed and Incline buttons, Heart rate sensors	LCD 6.5", Speed and Incline buttons, Heart rate sensors
Console Readings	Time, Distance, Heart rate, Calories, Speed, Incline, Pace, Track	Time, Distance, Heart rate, Calories, Speed, Incline, Pace, Track
Programs	5 + 2 HRC + 2 user	5 + 2 HRC + 2 user
Speed	1-20 Km/h	1-20 Km/h
Incline	Electronic 15 levels	Electronic 15 levels
Deck	Cushion Flex Whisper Deck	Cushion Flex Whisper Deck
Belt	56x152,5 cm	51x152,5 cm
Rollers	—	—
Dimensions (open)	208,4x96x170cm (folded 108x96x183,5cm)	196x88,5x169,5cm (folded 128,88,5x168,5cm)
Weight	121Kg	102Kg
Max User Weight	150 Kg	150 Kg
Other Specs	Fan, Phone/tablet holder, Bottle holder, USB port for charging, Accessory tray, Speakers via Bluetooth 3, Polar, SOLE+, Kinomap, Zwift apps via Bluetooth 5	Fan, Phone/tablet holder, Bottle holder, USB port for charging, Accessory tray, Speakers via Bluetooth 3, Polar, SOLE+, Kinomap, Zwift apps via Bluetooth 5

USAGE WITH PHONE

- + Bluetooth
- + SOLE+ app.
- + Data sync with Apple Health, Google Fit, Strava, Fitbit, MapMyFitness
- + Data sharing with Facebook, Instagram, Twitter



USAGE WITH PHONE

- + Bluetooth
- + SOLE+ app.
- + Data sync with Apple Health, Google Fit, Strava, Fitbit, MapMyFitness
- + Data sharing with Facebook, Instagram, Twitter



+ Speed & Incline buttons on the hand-grips

WARRANTY
1 year for commercial use



+ Speed & Incline buttons on the hand-grips

WARRANTY
1 year for commercial use



Progressive F350PI

92219
\$ 642,50



CHINA

Velos NF400PI

Category D1

92232
\$ 994,50



CHINA

Motor	3.50 hp
Console	LCD Blue 7", Speed and Incline buttons, Heart rate sensors
Console Readings	Time, Speed, Distance, Incline, Calories, Heart rate, Body fat
Programs	80 + manual + 5 user
Speed	1-22 Km/h
Incline	Electronic 20%
Deck	18mm thick
Belt	54x150 cm, 1.4mm thick
Rollers	Front 56mm, Rear 48mm
Dimensions (open)	201x86x143 cm
Weight	95Kg
Max User Weight	160 Kg
Other Specs	Transport wheels, Hydraulic assistance when folding/unfolding, Bottle holder, Speakers, USB, MP3, Book/tablet stand, APK

Motor	4.00 hp DC Brushless
Console	LED, 7 windows
Console Readings	Time, Distance, Heart rate, Calories, Speed, Incline, Body fat
Programs	36 + manual
Speed	1-22Km/h
Incline	Electronic 15%
Deck	Anti-shock 21mm
Belt	55x147 cm, 2.0mm thick
Rollers	—
Dimensions (open)	185x82x154 cm
Weight	125Kg
Max User Weight	150 Kg
Other Specs	Transport wheels, Bottle holder, Speakers, Phone/tablet stand, MP3



USAGE WITH PHONE

- + Bluetooth
- + Compatible APKs: Kinomap, Zwift, FitShow



USAGE WITH PHONE

- + Bluetooth
- + Compatible APKs: Kinomap, Zwift, AnyRun



+ Speed & Incline buttons on the hand-grips



Semi-Commercial Grade

NON-FOLDING

+ Speed & Incline buttons on the hand-grips



Velos BRF300PI

Category D1

92237



CHINA

Hermes F275PI

Category D1

92218

\$ 540,00



CHINA

Motor	DC Brushless 3.00 hp	2.75 hp
Console	6 LED windows, Speed and Incline buttons, Heart rate sensors	LCD Blue 7", Speed and Incline buttons, Heart rate sensors
Console Readings	Speed, Time, Incline, Distance, Heart rate, Calories	Time, Speed, Distance, Incline, Calories, Heart rate, Body fat
Programs	36 predefined + 3 user + body fat + manual	15 + manual
Speed	1-22 Km/h	1-18 Km/h
Incline	Electronic 15 levels	Electronic 18%
Deck	18mm with 6 elastic cushions to reduce knee straining	15mm thick
Belt	142x50 cm, 16cm distance from floor, 1,6mm thick	48x138 cm, 1.6mm thick
Rollers	56x50mm	Front 48mm, Rear 42mm
Dimensions (open)	172,0x79,5x144,0cm (folded 113,5x79,5x146,0cm)	191x80x140 cm
Weight	80,0Kg	85Kg
Max User Weight	130 Kg	130 Kg
Other Specs	Phone/tablet holder, Accessory tray, Speakers via Bluetooth, Transport wheels, Hydraulic unfolding, APK	Transport wheels, Hydraulic assistance when folding/unfolding, Bottle holder, Speakers via Bluetooth, APK

USAGE WITH PHONE

- + Bluetooth
- + Compatible APKs: Kinomap, Zwift, AnyRun



USAGE WITH PHONE

- + Bluetooth
- + Compatible APKs: Kinomap, Zwift, FitShow



+ Speed & Incline buttons on the hand-grips

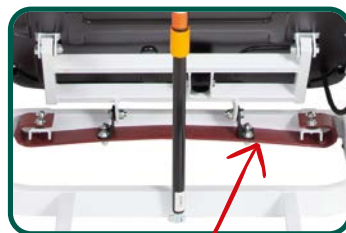

Anti-shock suspension under the front side of the deck

+ Speed & Incline buttons on the hand-grips



Velos F200PI

Category D1

92231
\$ 527,00

Velos F200PI

Category D1

92230
\$ 352,60



KINA

Motor	3.00 hp
Console	6 LED windows, Speed and Incline buttons, Heart rate sensors
Console Readings	Speed, Time, Incline, Distance, Heart rate, Calories
Programs	36 predefined + 3 user + body fat + manual
Speed	1-20 Km/h
Incline	Electronic 15%
Deck	18mm with 6 elastic cushions to reduce knee straining
Belt	142x50 cm
Rollers	55x50mm
Dimensions (open)	172,0x83,5x144,0cm (folded 113,5x79,5x146,0cm)
Weight	80,0Kg
Max User Weight	130 Kg
Other Specs	Phone/tablet holder, Accessory tray, Speakers via Bluetooth, Transport wheels, Hydraulic unfolding

Motor	2.00 hp DC
Console	3 LED windows
Console Readings	Time, Distance, Heart rate, Calories, Speed, Incline, Body fat
Programs	36 + manual
Speed	1-16Km/h
Incline	Electronic 12%
Deck	Anti-shock 15mm
Belt	42x125 cm, 1.4mm thick
Rollers	Front 42mm, Rear 42mm
Dimensions (open)	153,5x67,5x142 cm
Weight	59Kg
Max User Weight	120 Kg
Other Specs	Transport wheels, Bottle holder, Speakers, Phone/tablet stand, MP3, Transport wheels, Hydraulic unfolding



USAGE WITH PHONE

- + Bluetooth
- + Compatible APKs: Kinomap, Zwift, AnyRun



USAGE WITH PHONE

- + Bluetooth
- + Compatible APKs: Kinomap, Zwift, AnyRun



+ Speed & Incline buttons on the hand-grips



+ Speed & Incline buttons on the hand-grips



VELOS F300PI SLIM

Category D1

92235

\$ 569,00

Motor	3.00 hp
Console	6 LED windows, Speed and Incline buttons, Heart rate sensors
Console Readings	Speed, Time, Incline, Distance, Heart rate, Calories
Programs	36 predefined + 3 user + body fat + manual
Speed	1-18 Km/h
Incline	Electronic 12 levels
Deck	16mm with 6 elastic cushions to reduce knee straining
Belt	140x50 cm
Rollers	50x50mm
Dimensions (open)	170,0x79,0x128,0cm (folded 170,0x79,0x27,0cm)
Weight	75,0Kg
Max User Weight	120 Kg
Other Specs	Phone/tablet holder, Accessory tray, Speakers via Bluetooth, Transport wheels, Hydraulic folding



USAGE WITH PHONE

- + Bluetooth
- + Kinomap, Zwift & AnyRun apps



+ Speed & Incline buttons on the hand-grips

- !!! NO assembly needed
- !!! Compactly folds for easy storage, horizontal or vertical



KALOS F250PI

Category D1

92233
\$ 434,90

KALOS F300PI

Category D1

92234
\$ 569,00

Motor	2.50 hp	3.00 hp
Console	Color LCD console with 4 additional windows, Speed and Incline buttons, Heart rate sensors	Color LCD console with 4 additional windows, Speed and Incline buttons, Heart rate sensors
Console Readings	Speed, Time, Incline, Distance, Heart rate, Calories	Speed, Time, Incline, Distance, Heart rate, Calories
Programs	36 predefined + 3 user + body fat + manual	36 predefined + 3 user + body fat + manual
Speed	1-16 Km/h	1-20 Km/h
Incline	Electronic 12 levels	Electronic 12 levels
Deck	15mm with 12 elastic cushions (10 inside & 2 outside) to reduce knee straining	15mm with 6 elastic cushions to reduce knee straining
Belt	130x45 cm	140x50 cm
Rollers	46x46mm	50x50mm
Dimensions (open)	167,5x75,0x131,6cm (folded 110,0x75,0x136,5cm)	175,0x81,0x133,8cm (folded 96,2x81,0x150,5cm)
Weight	60,0Kg	77,0Kg
Max User Weight	120 Kg	130 Kg
Other Specs	Phone/tablet holder, Accessory tray, Bottle holder, Speakers via Bluetooth, Transport wheels, Hydraulic unfolding	Phone/tablet holder, Accessory tray, Bottle holder, Speakers via Bluetooth, Transport wheels, Hydraulic unfolding



USAGE WITH PHONE

- + Bluetooth
- + Kinomap, Zwift & AnyRun apps



USAGE WITH PHONE

- + Bluetooth
- + Kinomap, Zwift & AnyRun apps



+ Speed & Incline buttons on the hand-grips



+ Speed & Incline buttons on the hand-grips



Tempus F250PI

Category D1

92208

\$ 347,00



CHINA

Aura F250

Category D1

92207

\$ 303,00



CHINA

Motor	2.50 hp DC Brushless	2.50 hp DC Brushless
Console	4 LED windows, Speed and Incline buttons, Heart rate sensors	3 LED windows, Speed buttons, Heart rate sensors
Console Readings	Time, Distance, Heart rate, Calories, Speed, Incline	Time, Distance, Heart rate, Calories, Speed
Programs	12	—
Speed	1-16Km/h	1-15Km/h
Incline	Electronic 25 levels	—
Deck	Anti-shock 15mm with 2 pcs of elastomer	Anti-shock 15mm with 2 pcs of elastomer
Belt	50x121 cm, 1.6mm thick	46x121 cm, 1.6mm thick
Rollers	Front 42mm, Rear 42mm	Front 42mm, Rear 42mm
Dimensions (open)	154x78x127cm	157x77x123cm (folded 157x77x40cm)
Weight	55Kg	45Kg
Max User Weight	120 Kg	120 Kg
Other Specs	Transport wheels, Phone/tablet stand, Fan	Transport wheels, Phone/tablet stand, Speakers



USAGE WITH PHONE
 + Bluetooth
 + Compatible APKs:
 Spax, Zwift, Kinomap



USAGE WITH PHONE
 + Bluetooth
 + Compatible APKs:
 Spax, Zwift, Kinomap



NON-FOLDING



+ Speed buttons & Start/Stop on the hand-grips



Supporting frame to store it in a vertical position



Flow F250PI

Category D1

92236
\$ 385,00



CHINA

Orion F250PI

Category D1

92206
\$ 258,00



CHINA

Motor	DC 2.50 hp
Console	4 LED windows, Speed and Incline buttons, Heart rate sensors
Console Readings	
Programs	Speed, Time, Incline, Distance, Heart rate, Calories, Body fat
Speed	36 predefined + 3 user + body fat + manual
Incline	1-18 Km/h
Deck	Electronic 12 levels
Belt	15mm with 6 elastic cushions to reduce knee straining
Rollers	125x45 cm, 1,6mm thick
Dimensions (open)	46x46mm
Weight	158,0x73,0x139,5cm (διπλωμένος 103,5x73,0x139,5cm)
Max User Weight	60,0Kg
Other Specs	120 Kg
	Phone/tablet holder, Accessory tray, Transport wheels, Hydraulic unfolding

Motor	2.50 hp DC Brushless
Console	3 LED windows, Speed buttons, Heart rate sensors
Console Readings	Time, Distance, Heart rate, Calories, Speed, Incline
Programs	16
Speed	1-15Km/h
Incline	Electronic 20 levels
Deck	Anti-shock 15mm with 2 pcs of elastomer
Belt	45x120 cm, 1.6mm thick
Rollers	Front 42mm, Rear 42mm
Dimensions (open)	143,5x75,5x115cm
Weight	43Kg
Max User Weight	120 Kg
Other Specs	Transport wheels, Phone/tablet stand



USAGE WITH PHONE

- + Bluetooth
- + Compatible APKs: Kinomap, Zwift, AnyRun



USAGE WITH PHONE

- + Bluetooth
- + Compatible APKs: Spax, Zwift, Kinomap



+ Speed & Incline buttons on the hand-grips



NON-FOLDING



For a long-term and worry-free use of a treadmill, the correct lubrication is a must

Treadmill Lubricants

It is essential to lubricate the bottom part of the treadmill's belt at regular intervals, depending on how often you use it. It is something the user himself can and should do, simply by lifting the belt by hand and spraying the deck. **Lubrication should be performed approximately every 20-30 hours of use.**

These silicon lubricants will keep your treadmill in excellent condition for many years. The 350-1000 mixture is ideal since it is thicker than the 350-density silicone, lasting for a lot more time.

In Spray Form

70056

\$ 5,90



In a Bottle

CODE	PRICE	QUANTITY
70057	\$ 9,00	190ml
70058	*****	500ml

Caution: Excessive lubrication should be avoided, causing the belt to slip. On the other hand, insufficient lubrication will damage the belt, risking damage to the motor.

Category E6

44097

\$ 24,20

Polar Heart Rate Receiver

- The most popular accessory for dedicated runners
- Essential accessory for using your treadmill with Heart Rate Programs



- You can see your day-by-day progress; also helps you to not pressure your heart too much

Category F1



AMILA® **TREADMILLS**

ΕΛΛΕΙΠΤΙΚΑ

Πως Διαλέγουμε Ελλειπτικό

Τα ελλειπτικά χωρίζονται βάση δυο κριτηρίων:

- A.** Ανάλογα με του που βρίσκεται ο δίσκος (οι μαγνήτες)
- B.** Ανάλογα με τον τρόπο που δημιουργείται η αντίσταση

[A] Πλεονεκτήματα ελλειπτικών με τον δίσκο εμπρός

1. Η άσκηση γίνεται με πιο φυσικό και ξεκούραστο τρόπο διότι το πέλμα κινείται παράλληλα με το έδαφος και δεν επιβαρύνεται η περιοχή του αστραγάλου.
2. Η γωνία κλίσης του πέλματος όταν ο δίσκος είναι πίσω εξαρτάται από το μήκος του ελλειπτικού.
3. Λόγο σχεδιασμού, μπορούν να υποστηρίξουν χρήστες με μεγαλύτερο βάρος.

Μειονεκτήματα ελλειπτικών με τον δίσκο εμπρός

1. Έχει μεγαλύτερο μήκος. Η λύση σε αυτό το πρόβλημα δόθηκε με το πτυσσόμενο ελλειπτικό (#43331).
2. Η τιμή τους είναι συνήθως υψηλότερη από εκείνων με τον δίσκο πίσω.
Στην περίπτωση που η τιμή είναι παραπλήσια τότε συνίσταται το ελλειπτικό με μπροστινό δίσκο διότι το όφελος από την φυσική κίνηση υπερκαλύπτει όλα τα άλλα πλεονεκτήματα που ενδεχομένως μπορεί να έχει κάποιο ελλειπτικό με τον τροχό πίσω.

[B] Σύστημα Αντίστασης:

1. Χειροκίνητη διαβάθμιση αντίστασης.
2. Ηλεκτρονική διαβάθμιση αντίστασης.

Πλεονεκτήματα:

- Πολύ καλή διαβάθμιση της αντίστασης
- Δυνατότητα μέτρησης έργου σε WATT
- Δυνατότητα προγραμματισμού

3. EMS (ElectroMagneticSystem)
Ηλεκτρομαγνητική αντίσταση
(ελλειπτικά που οι μαγνήτες τους είναι ηλεκτρομαγνήτες)

Πλεονεκτήματα:

- Απόλυτα ομαλή κίνηση
- Αθόρυβη λειτουργία

4. Generator: Είναι μια βελτιωμένη έκδοση του EMS που η αντίσταση προέρχεται από την παραγωγή ενέργειας και έτσι δεν υπάρχει η ανάγκη παροχής ρεύματος. Τα συναντούμε κυρίως σε επαγγελματικά όργανα.

5. SpinElliptical: Τα SpinElliptical είναι στην κορυφή της ποιότητας και της απόδοσης.

Η αντίσταση προέρχεται από το δίσκο αδρανείας. Έχει πολύ μεγάλη σημασία το βάρος του δίσκου διότι αποτελεί τον καθοριστικό παράγοντα της ποιότητας. Η αντίσταση ενισχύεται είτε με φρένα (τακάκια), είτε με μαγνήτες νεοδυμίου.

Πλεονέκτημα:

- Ο αθλητής φτάνει πολύ πιο εύκολα σε αερόβια άσκηση ανεβάζοντας παλμούς στους 130 (70% της μέγιστης ικανότητας του) χωρίς μεγάλη κόπωση (floating effect).
- Απόλυτα ομαλή αντίσταση και στις 360° της κίνησης.

Μαγνήτες

Οι μαγνήτες ενός απλού μαγνητικού, μετά από μακρόχρονη χρήση, είναι δυνατόν να απομαγνητιστούν. Αυτός είναι και ο λόγος που δεν χρησιμοποιούνται σε επαγγελματικά ποδήλατα. Τα μεγάλα ελλειπτικά της AMILA - με μπροστινό δίσκο που παράγονται από τη DYACO, έχουν λύσει αυτό το πρόβλημα αντικαθιστώντας τους απλούς μαγνήτες με **μαγνήτες νεοδυμίου**.

Βάρος Δίσκου

Το βάρος του δίσκου έχει πολύ μικρή σημασία στα μαγνητικά και ελλειπτικά ποδήλατα

Κύρια Σημεία Καταπόνησης

Σημαντικό ρόλο στην ποιότητα ενός ελλειπτικού παίζει το ποσοστό ενίσχυσης των τριών κύριων σημείων που υφίστανται την μεγαλύτερη καταπόνηση

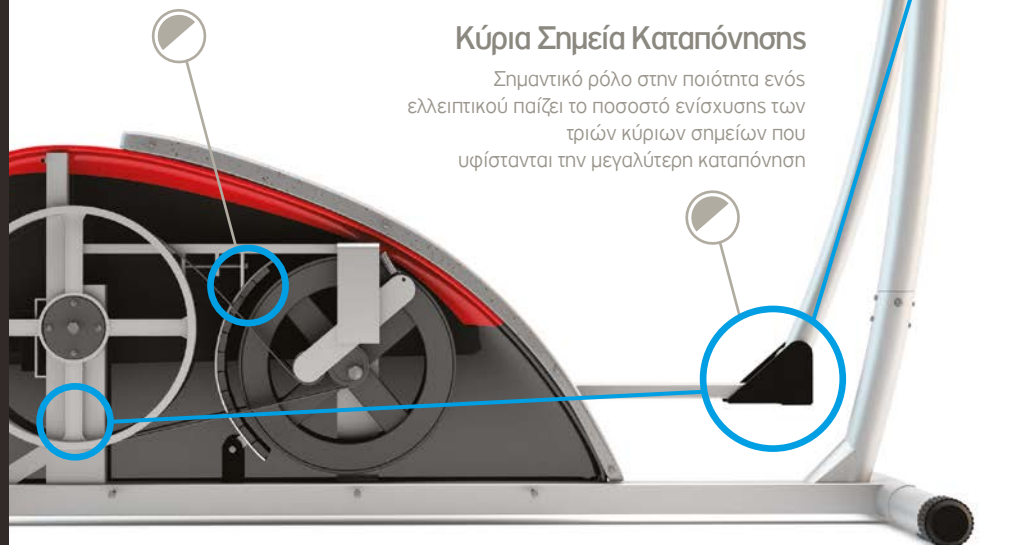

Μπορούμε πολύ γρήγορα να ελέγξουμε την ποιότητα ενός ελλειπτικού προσέχοντας:

- αν σε όλη τη στροφή η αντίσταση είναι ίδια και αρμονική (smooth function)
- αν η κλιμάκωση της αντίστασης γίνεται εύκολα αντιληπτή αλλάζοντας διαδοχικά τις διαβαθμίσεις

Δρασκελισμός

Όσο μεγαλύτερος είναι ο δρασκελισμός τόσο πιο αποτελεσματική είναι η άσκηση.

Σχέση Μετάδοσης

Οι διάμετροι των δυο τροχών ενός ελλειπτικού δημιουργούν τη σχέση μετάδοσης. Στο παράδειγμα απεικονίζεται η σχέση του 43236 η οποία προκύπτει από το παραγόμενο κλάσμα των δυο διαμετρημάτων των δίσκων: $\frac{\varnothing 379}{\varnothing 40} = 9.5 / 1$

Όταν ο μεγάλος δίσκος κάνει μια περιστροφή (μια πλήρη ελλειπτική κίνηση) ο μικρός δίσκος έχει κάνει 9.5. Αυτό έχει ως αποτέλεσμα τη συχνότερη επαφή των μαγνητών και επομένως την ομαλότερη αντίσταση.

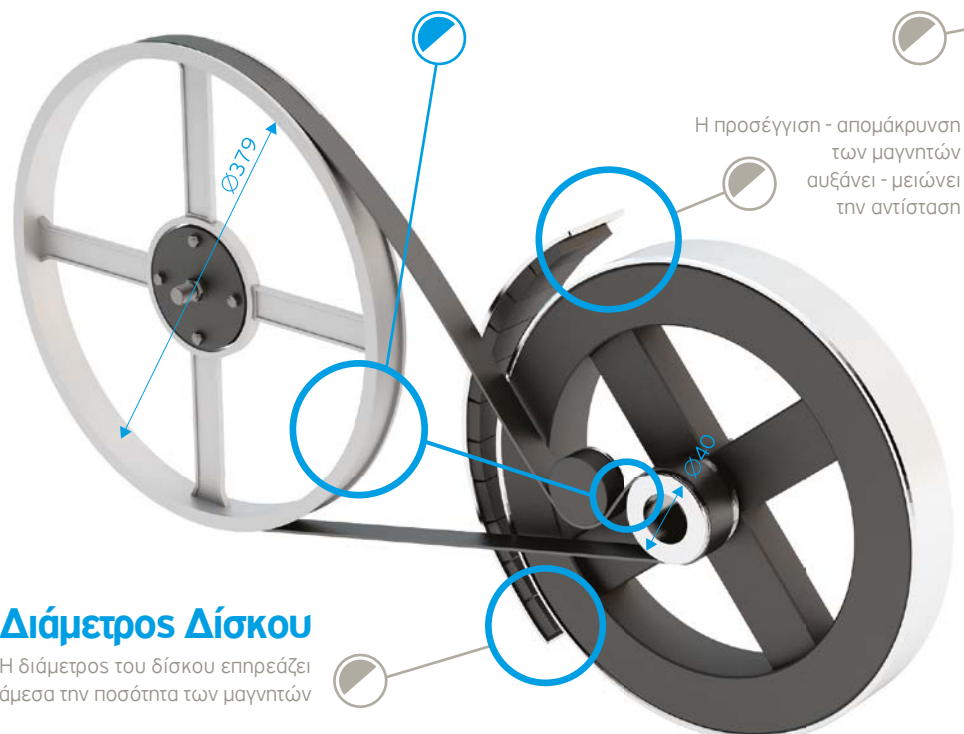

Διάμετρος Δίσκου

Η διάμετρος του δίσκου επηρεάζει άμεσα την ποσότητα των μαγνητών

Ποδήλατα

Πως Διαλέγουμε Ποδήλατο Γυμναστικής Τα ποδήλατα χωρίζονται σε δυο κατηγορίες

- A. Ορθια ή Καθιστά
- B. Ανάλογα με τον τρόπο που δημιουργείται η αντίσταση (ακριβώς όπως στα ελλειπτικά, χωρίς καμία διάφορα)

Καθιστά VS Ορθια Ποδήλατα

Πλεονεκτήματα Καθιστών

- Πολύ λιγότερη καταπόνηση της μέσης. Βασικός παράγων για άτομα που έχουν παθήσεις στη μέση ή στην σπονδυλική τους στήλη. Γι' αυτόν τον λόγο το καθιστό ποδήλατο είναι το μόνο όργανο που συνιστά η Ένωση Αμερικανών Ορθοπεδικών.
- Η άσκηση είναι πιο ξεκούραστη, χωρίς να μειώνεται η αποτελεσματικότητά της.

Μειονεκτήματα Καθιστών

- Απαιτούν μεγαλύτερο χώρο.
- Ακριβότερα από τα όρθια ποδήλατα.

Προσαρμοστικότητα

Η δυνατότητα της σέλας να προσαρμόζεται σε πολλαπλά σημεία, καθώς η ποιότητα των υλικών, επιδρούν στην άνεση της άσκησης. Ο χρήστης βρίσκει το ιδανικό σημείο για το σωματότυπο του.

Στα μαγνητικά ποδήλατα δεν έχει σημασία το βάρος του δίσκου. Σημαντικό ρόλο παίζει η διάμετρος η οποία υποδηλώνει την ποσότητα των μαγνητών. Όσο περισσότεροι μαγνήτες, τόσο πιο ομαλή και ποιοτική γίνεται η αντίσταση.

Σχέση Μετάδοσης

Η σχέση μετάδοσης της κίνησης είναι ένα σημείο που δεν προσέχουν πολλοί όμως παίζει σημαντικό ρόλο στην άσκηση.

Μανιβέλα

Υπάρχουν δυο τύποι μανιβέλας, ενός τεμαχίου και τριών. Οι μανιβέλα τριών τεμαχίων λόγω του ότι επιτυγχάνει γωνίες 90° συμβάλει στην άνεση της άσκησης, σε σχέση με τον απλό τύπο.

Ρυθμίσεις

Το πλάτος του καθίσματος και η δυνατότητα ρύθμισης της πλάτης αποτελούν σημαντικούς παράγοντες στην άνεση κατά τη χρήση.

Η στιβαρότητα κατασκευής, ο τρόπος που στηρίζεται το κάθισμα καθώς και το εύρος των ρυθμίσεών του, η απόσταση από τα πετάλια ώστε ο χρήστης να βρίσκει εύκολα την πλέον κατάλληλη θέση, είναι πολύ σημαντικά για τη σωστή άσκηση. Μια μη άνετη θέση μπορεί να προκαλέσει προβλήματα στα γόνατα του χρήστη.

Εργονομία

Στιβαρότητα

Η στιβαρότητα σε ένα ποδήλατο [βάρος, διατομή σκελετού] παίζει σημαντικό ρόλο για μια σταθερή και ασφαλή άσκηση.

Επιπλέον παράγοντες που επηρεάζουν την ποιότητα ενός ελλειπτικού

1. Ομαλή λειτουργία (smooth function)

Η ομαλή λειτουργία του ελλειπτικού χωρίς "κρατήματα" (smooth function) εξαρτάται από:

- την διάμετρο του δίσκου (δηλωτική της ποσότητας των μαγνητών).
- την ποσότητα των μαγνητών.
- την ποιότητα των μαγνητών.
- από τη σχέση μετάδοσης μεταξύ κεντρικού ρουλεμάν και δίσκου.

Μια μεγάλη σχέση μπορεί να αντισταθμίσει την ποσότητα των μαγνητών (το υποτιθέμενο βάρος του δίσκου).

2. Η ποιότητα, στιβαρότητα και σταθερότητα του ελλειπτικού συντελεί στην απουσία τριγμών δημιουργώντας την αίσθηση άνεσης. Οι παράγοντες αυτοί εξαρτώνται από:

- τη Διατομή του σκελετού,
- το Πάχος του,
- το Μέγεθος σκελετού και
- το ποσοστό ενίσχυσης των τριών κύριων σημείων που υφίστανται την μεγαλύτερη καταπόνηση. (Βλέπε Εικόνα Ελλειπτικού)

43342

\$ 945,00



- **Best** full body workout in its class
- **Eliminates** strain from hips, ankles, and knees
- **Integrated** technology makes progress easy
- **Multigrip** handles and adjustable foot pedals
- **Bluetooth** heart rate monitor
- **Bluetooth** speaker

Pedals that adjust to different settings, allowing for multiple users with varying heights and strides to be able to use the machine comfortably and eliminates the «numb toe» feeling sometimes associated with elliptical use.

The 2 degree inward slope realigns the body into its correct posture for workouts limiting aches and pains, creating a comfortable workout, thus increasing the longevity of wanting to exercise.



E35 SOLE

Built-in wireless heart rate receiver and chest strap, Bottle holder, USB charging, Bluetooth HR, Bluetooth Speaker, Cooling Fans, Tablet holder

Computer: LCD 7,5" backlit with multiple concurrent readings

Readings: Time, Speed, Distance, Heart rate, Calories, Level, Program, Pace, Rotations per minute, Watt, Laps & Incline

Programs: 5 + 1 manual + 2 user + 2 HRC

Disk: 11,4Kgr

Rail: **Double rail for increased stability**

Incline: **20 levels (electronically controlled)**

Resistance: 20 levels (electronically controlled)

Weight: 111Kg

Stride: 51cm

Pedal angle adjustment: 3 levels, using a pin

Heart Rate: Touch and wireless

Max User Weight: 150Kg



➤ External power source (included in the packaging)

209×82×180cm

Category
F1

92306

\$ 395,00



CHINA

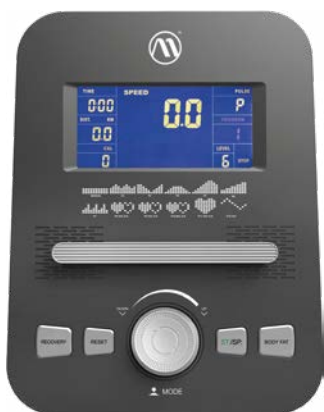

USAGE WITH PHONE

- + Bluetooth
- + Compatible APKs: Kinomap, Zwift



158,5x56x170,8cm

Category D3

EFIT 41800HP

Tablet/smartphone stand. USB charging. Integrated transport wheels. Bottle holder.

Console: LCD 131x67mm

Readings: Time, Speed, Distance, Pulse, Scan, Calories, Watt, RPM, Body fat, Recovery

Disk: 7Kg, 260mm

Stride: 400mm

Transmission: Belt

Resistance: Electromagnetic 16 levels

Axle: Ø20x224mm

Pedals: 417x210mm, 77mm apart

Main tube: 50x55x1,5mm

Weight: 53,6kg

Gear ratio: 1:7

Heart rate: Touch and Wireless

Max User Weight: 120Kg

> External power source (included in the packaging)

92307

\$ 267,00



CHINA



USAGE WITH PHONE

- + Bluetooth
- + Compatible APKs: Kinomap, Zwift & FitShow



132x53x158cm

Category D3

EX6P

Tablet/smartphone stand. Bluetooth & APK. Integrated transport wheels.

Console: LCD 132x66mm

Programs: 13

Readings: Time, Speed, Distance, Pulse, Calories, RPM, Watt, Body fat

Disk: 6Kg, 280mm

Stride: 340mm

Transmission: Belt

Resistance: Electromagnetic 32 levels

Axle: Ø20x141mm

Pedals: 394x155x75mm

Weight: 43,5 Kg

Heart rate: Touch

Max User Weight: 120Kg

92305

\$ 242,00



CHINA



USAGE WITH PHONE

- + Bluetooth
- + Compatible APKs: Kinomap, Zwift & iConsole



117,5×52,8×164,5cm

Category D3

EX6

Tablet/smartphone stand. **Bluetooth & APK.** Integrated transport wheels.

Console: LCD 80x50mm

Readings: Time, Speed, Distance, Pulse, Calories, RPM, Scan, Body fat

Disk: 6Kg, 240mm

Stride: 340mm

Resistance: Magnetic/manual 8 levels

Axle: Ø20x141mm

Pedals: 394x155x75mm

Heart rate: Touch

Transmission: Belt

Weight: 41,5 Kg

Max User Weight: 120Kg

92300

\$ 180,00



CHINA



SCAN HERE

to view the Assembly Video on our YouTube channel.



129×59×159cm

Category D3

Cardio 5105E

Electromagnetic. Integrated transport wheels.

Readings: Time, Speed, Distance, Calories, Heart rate, Scan, Odo

Disk: 4Kg

Resistance: Magnetic/manual 8 levels

Weight: 25 Kg

Pedals: Large size, non-skid

Heart rate: Touch

43345

\$ 309,00



CHINA



> Oversized pedals



> Adjustable seat

USAGE WITH PHONE

- + Bluetooth
- + Compatible APKs: Kinomap, Zwift & XTERRA+



> Anatomic cushion



> External power source (included in the packaging)

148,5×65×116,5cm

Category D3

R15 XTERRA FITNESS

Mobile device holder. Adjustable seat. Bottle holder. Oversized pedals. Integrated transport wheels.

Computer: LCD 14cm blue back-lit with 6 buttons

Readings: Time, Speed, Watt, Distance, Calories, Heart rate, RPM, Body fat, HR Control, Pulse recovery

Disk: Ø260mm, 7Kg

Programs: 12 preset, 4 user, 5 HRC, 1 body fat, 1 manual

Crank arm: 340mm

Resistance: Electronic 24 levels

Weight: 37,8Kg

Heart rate: Touch and Polar

Max User Weight: 120Kg

92451

\$ 247,00



CHINA



ATLAS 600R AMILA®

Tablet stand

Computer: LCD 111x61,5mm with 5 buttons

Readings: Time, Speed, Distance, Calories, Heart rate, Rotations per minute, Body fat, Recovery, Temperature

Disk: Ø240mm, 5Kg

Gear ratio: 01:07,6

Bearings: 6000Z

Axle: Ø17mm thick

Transmission: Belt

Main tube: Rectangular, 80×40×2mm

Resistance: Manual 10 levels

Weight: 44Kg

Heart rate: Touch

User height: 155-190cm

Max User Weight: 120Kg



SCAN HERE to view the Assembly Video on our YouTube channel.

161×67×114cm

Category D3

44201

\$ 384,50

 TAIWAN

**HOME
USE**



CRANK

Home use, as well for Hotels and very small Gyms.
Not suitable for group sessions.

Grips: Adjustable Up-Down, Front-Back

Seat: Adjustable Up-Down, Front-Back

Drive: Chain

Disk: 18,5Kgr cast iron

Resistance: Manually adjustable

Bearings: Plain

Axle: 1,37" x 24T

Crank: 1/8", 52t, 170mm

Weight: 47kg

Ratio: 1:3

Max user weight: 130Kg

130x65x130cm

Category
D3

92408

\$ 204,20



CHINA



!!! The pictured tablet IS NOT included !!!



Corsa IC911

Console: LCD 7,7x4,3cm with Set, Mode/Enter & Reset/Recovery buttons

Readings: Speed, Time, Distance, RPMs, Calories, Scan

Programs: User, Calories

Grips: Adjustable Up-Down

Seat: Adjustable Up-Down, Front-Back

Drive: Belt

Resistance: 8 levels, manually adjustable

Bearings: 3 pcs

Axle: Ø20x170mm

Weight: 37,2kg

Ratio: 1:5,7

Heart rate: Touch

Max user weight: 110Kg

154,5x54x110cm

Category D3

44217

\$ 235,00



SCAN HERE 
to view the Assembly Video on our YouTube channel.



Cyclocross AMILA®

Transport wheels. Emergency brake.

Resistance: Hand regulated, break on the top side

Console: LCD

Display: Scan, Speed, Time, Distance, Calories, ODO

Saddle: Adjustable, front/back & up/down

Handlebars: Adjustable, front/back & up/down

Transmission: Belt

Disk: Ø460mm 18kg

Weight: 44kg

Max user weight: 125Kg



115x52x116cm

Category F1

92405

\$ 239,00



CHINA



SCAN HERE to view the Assembly Video on our YouTube channel.



> External power source (included in the packaging)

109×54×142cm

Category D3

Aston BX7P

Integrated transport wheels. Tablet/smartphone holder. Magnetic bike.

- Readings:** Time, RPM, Distance, Heart rate, Speed, Watt, Calories, Recovery, Body fat
- Transmission:** Belt
- Disk:** 5Kg
- Crank:** Three-piece
- Resistance:** Electronically adjusted
- Programa:** 12 + HRC + Watt + User
- Seat:** Adjustable Up-Down, Front-Back
- Grips:** Padded armrests
- Heart rate:** Touch
- Max User Weight:** 120Kg

92403

\$ 219,90



CHINA



109×54×142cm

Category D3

Aston BX7

Integrated transport wheels. Tablet/smartphone holder. Magnetic bike.

- Readings:** Time, Distance, Heart rate, Speed, Calories, Recovery, Body fat
- Transmission:** Belt
- Disk:** 5Kg
- Crank:** Three-piece
- Resistance:** Manual/magnetic 10 levels
- Seat:** Adjustable Up-Down, Front-Back
- Grips:** Padded armrests
- Weight:** 34 Kg
- Heart rate:** Touch
- Max User Weight:** 120Kg

92406

\$ 133,90



CHINA



Aston BX2

Magnetic bike. Belt drive. Integrated transport wheels. Tablet/smartphone holder.

Console: LCD, screen size 111x61,5mm

Readings: Time, Speed, Distance, Calories, Heart rate, RPM, Recovery, Body fat, BMI, BMR, Scan

Transmission: Belt

Disk: 4Kg

Crank: One-piece

Resistance: Manual/magnetic 8 levels

Seat: Adjustable Up-Down, Front-Back

Weight: 24,5 Kg

Heart rate: Touch

Max User Weight: 100Kg

83x50x137cm

Category D3

92351

\$ 238,50

> **Readings:** Time, Time/500m, SPM, Distance, WATT, Strokes, Total strokes, Calories

> **Pulse:** Wireless receiver

> **Resistance:** Magnetic 12 levels

> **Beam:** Aluminium



- > Durable pulling rope
- > Anti-skid pedals with quick-adjust strap
- > Oversized padded seat provides a soft secure ride
- > Space saver storage
- > Wheels for easy transport



SCAN HERE to view the presentation video on our YouTube channel

Magnetic Rower



Adjustable pedals, with quick adjustment straps



The innovative (Double Slide) aluminium rail offers durable stability



Weight 50kg

Category D7

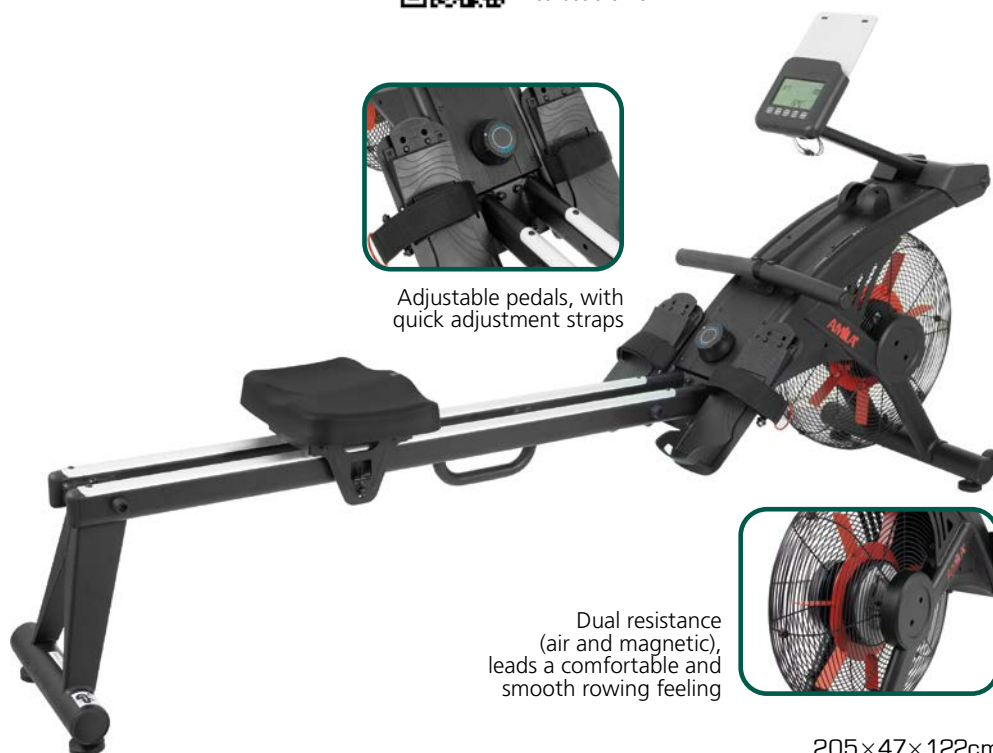

Dual resistance (air and magnetic), leads a comfortable and smooth rowing feeling

205x47x122cm

92352

\$ 260,00

- > **Readings:** Time, Time/500m, SPM, Distance, WATT, Strokes, Total strokes, Calories, Pulse
- > **Programs:** 12 ready-made, Body Fat, Watt, 4 HRC, 4 User, Recovery
- > **Pulse:** With optional wireless receiver
- > **Resistance:** Magnetic 16 levels
- > **Beam:** Aluminum covered steel, length 115cm
- > **Movement range:** 875mm
- > **Seat:** PU with bearings
- > **Pedals:** Adjustable with straps
- > **Seat height from floor:** 40cm
- > **Max user height:** 2m
- > **Max user weight:** 120Kg



MyRow40 Magnetic Rower

Dual resistance (air and magnetic), leads a comfortable and smooth rowing feeling

The double aluminium rail offers durable stability

Adjustable pedals, with quick adjustment straps



Weight
37,0kg

Category
D3

> Can be stored vertically to save space
138×48×198cm

180,5×50×112cm

92357

\$ 185,10

- > **Console:** LCD 86x58mm, Time, Time/500m, Distance, Watt, Pulse, Calories, Strokes per minute, Strokes, Total strokes
- > **Drive:** Belt
- > **Beam:** Aluminum alloy 109,5cm
- > **Movement range:** 84,6cm
- > **Seat distance from the ground:** 430-452mm
- > **Resistance:** Magnetic, 12 levels
- > **Disk weight:** 2,5kg
- > **Max user weight:** 100Kg



USAGE WITH PHONE

- + Bluetooth
- + Compatible APKs: Kinomap, FitShow

PowerStroke ET7433R Magnetic Rower



Long beam to accommodate most users

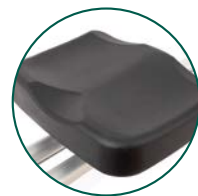

Big and comfortable seat

Belt drive

Big size adjustable pedals



Weight 28 Kg Category D3

> Can be stored vertically to save space
101x50x155cm

194x50x96cm

Rowing machines | Air walkers

92356

\$ 183,90

- > **Readings:** LCD 75x42mm, Time, Distance, Calories, Clock
- > **Drive:** Belt
- > **Beam:** Aluminium 109cm
- > **Resistance:** Magnetic, 12 levels
- > **Disk weight:** 2,5kg
- > **Max user weight:** 110Kg

- > Foldable, requiring small storage space
- > Tablet stand



USAGE WITH PHONE

- + Bluetooth
- + Compatible APKs: Kinomap, FitShow



Air/Magnetic Rower

Weight
27 Kg

Category
D3

200x47x85cm

44286

\$ 154,90

Trains the hips. Feet and hands movement pistons. Double immobilization safety and height adjustment

- > **6 levels adjustable resistance**
- > **Counter:** Time, Calories, Distance, Reps/min
- > **Max user weight:** 100kg
- > **Packaging:** Box



Air Walker

With adjustable resistance

44272

\$ 134,90

Trains the hips. Feet and hands movement pistons. Double immobilization safety and height adjustment

- > **Counter:** Time, Calories, Distance, Reps/min
- > **Max user weight:** 100kg
- > **Packaging:** Box



Air Walker

102x83x135cm

108x74x138cm



Weight
24.5kg

Category
D7



Weight
26kg

Category
D7

44079

\$ 115,50

- Exercises heart, lungs and vascular system

> **Counter:** Scan, Time, count, Total count, Calories

> **Max user weight:** 80Kg

• **Movement:** Front-back and sideways

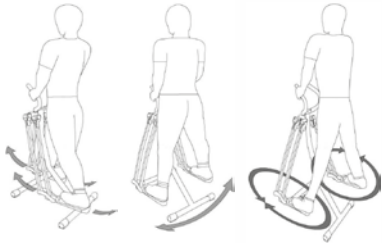

2-in-1 Air Walker & Split Thigh

Non-impact aerobic action makes exercising easier for people of all ages



Assembled 79x53x128cm
Folded 40x53x138cm



SCAN HERE to view the presentation video on our YouTube channel



Weight 17 Kg

Category E6

44078

\$ 52,50

2-in-1 Exercise Pedaler

Simple way to exercise upper and lower body



- Post angle adjustable
- Improves body flexibility and circulation

> **Tension:** Adjustable by hand



100x54x43cm

Weight 6 Kg

Category E6

> **Material:** Rubber
> **Packaging:** Box

Rubber Protection Mat



CODE	PRICE	DIMENSIONS
81724	\$ 20,30	200x92,5x0,4 cm
81725	\$ 16,40	160x87,0x0,4 cm
81726	\$ 9,35	100x70,0x0,4 cm

Category E4

46420

\$ 1.199,00

Power Cage

+ Very strong 7,5x7,5cm x 3mm beam construction



Büpos 340 kg Category F2

! The accessories with the icon "⚠" are not included with Power Cage (#46420)

314x211x274cm

J-hooks

⚠ 46422

\$ 57,80



Safety holder

⚠ 46423

\$ 76,50



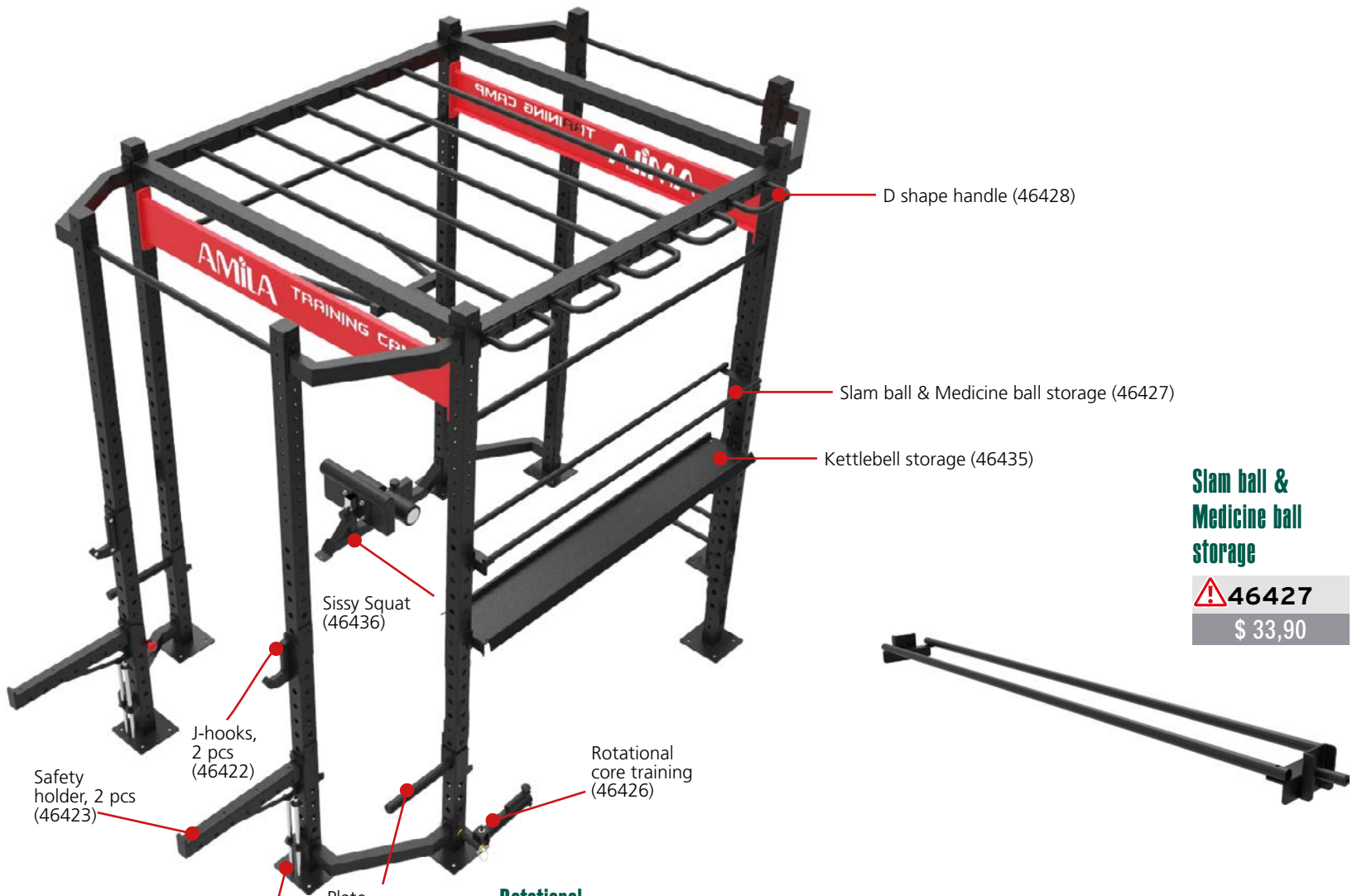

Slam ball & Medicine ball storage

⚠️ 46427
\$ 33,90



Rotational core training

⚠️ 46426
\$ 25,30



Sissy Squat

⚠️ 46436
\$ 91,80

Dip horn

⚠️ 46421
#N/A!



Plate storage

⚠️ 46425
\$ 36,50



D shape handle

⚠️ 46428
\$ 16,80



Power band pegs

⚠️ 46424
\$ 29,00



95200

\$ 373,50

- > **Tubes:** 76,2x50,8x3mm
- > **Holes:** Laser cut, 25 holes of a 16,2mm diameter
- > **Accessories included:** 2 nylon covered J-Hooks, 4 Pegs for bands and 2 bar-storage receptacles
- > Can be screwed to the floor



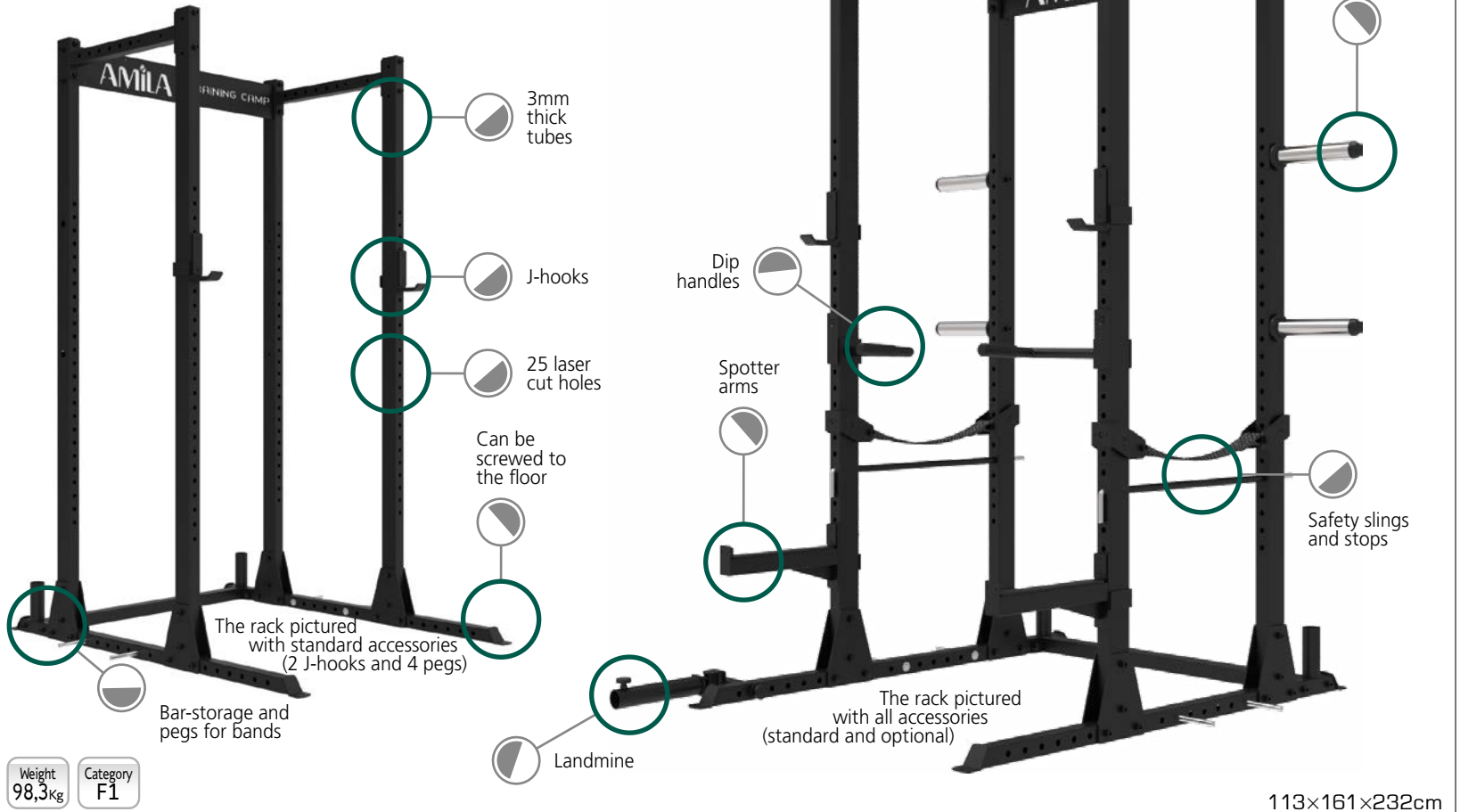





Power Rack Compact Training Camp



Weight 98,3kg
Category F1

113x161x232cm

Customize your Rack according to your needs by adding accessories from the wide variety of AMILA Power Rack Training Camp. The available accessories to choose from are as follows:

<p>Multiple grip chin-up bar</p>  <p>95220 \$ 43,80</p>	<p>Chin-up bar</p>  <p>95221 \$ 17,90</p>	<p>Safety sling</p>  <p>95222 \$ 45,40 (2 pcs)</p>
<p>Spotter arms</p>  <p>95223 \$ 56,80 (2 pcs)</p>	<p>Safety stop</p>  <p>95224 \$ 23,40 (2 pcs)</p>	<p>J-hooks</p>  <p>95225 \$ 23,90 (2 pcs)</p>
<p>Landmine</p>  <p>95226 \$ 27,90</p>	<p>Dip handles</p>  <p>95227 \$ 41,10 (2 pcs)</p>	<p>4 pcs plate storage</p>  <p>95228 \$ 39,40 (4 pcs)</p>

43963

\$ 268,20

> Tube size: 60x60x2mm

Alpha Power Rack

The ideal power rack for people with limited available space



Pull-up grips

The split pull-up grips let you choose the ones you need for your workout

Adjust it to your needs

The J-Hooks' and safety bars' adjustable height allows you to adjust the Power Rack according to your needs

Base

The holes on the base allow you to bolt it on the floor for added stability

Category F1

214x118,9x133,7

91206

\$ 132,80

> Tube: 40x80x1.5mm

> Max-weight:
J-hooks: 110kg
Spotter arms: 110kg
Chin-up bar: 110kg

Semi-Commercial Grade

Half Rack HR350



Distance between arms: 1m

Weight 37kg

Category F1

129x151x218cm

46105

\$ 189,70

> Tubes: 60x10x2 and Ø32x1,5

AMILA® Iron Wall Bar

FULL Commercial Grade



> Rings: Eight on each side to connect Gym bands

Category F1

260x100x46cm

70065

\$ 232,30

Reinforced, higher quality wood with anti-humidity sealer

> Material: Sustainable high quality Sal wood
> Bars: 4cm diameter
> Wall mountable (4 points)
> Strength: 120kg

Wall Bar



Weight 26,5kg

Category F6

250x100x24,5cm

Time to relax Time for MASSAGE

AMILA®



We have focused in creating a series of comfortable massage chairs, with the [quality and functionality of AMILA products](#), that will fully cover everyone's needs without limitations.

TRAIN WITHOUT PAINS AFTER

Athletic masage **relieves** cramps, **reduces muscle spasms** by removing lactic acid.

It is by far **the most effective way to deal with inflammation caused by sport activities** and the best in preventing and recovering from micro-injuries from intense training.





COMFORT AT HOME

Place a massage chair in your house and enjoy the quality of a modern clinic when you need it, without any second thoughts.

INNOVATING IN HOSPITALITY

Don't follow the stereotypes, stand out. Place a massage chair in your hotel room on the days you are asked for it and supply your guests with a **unique hospitality experience** after an exhausting day of outdoor activities or when the weather does not allow them.



S-Shape

The **body supporting S-shape** includes a combination of back massage structures and human mechanics principles, so that you can enjoy a high-tech back massage. It provides support to both your neck and back, especially in the lumbar region



ZERO GRAVITY

The 135° and 118° zero gravity angles, simulating space flight, move thighs and calves higher than the waist, achieving full relaxation.



FULL BODY STRETCH

This position increases the massage effects as it allows to each spinal disc to individually separate and decompress, allowing nutrients to enter the disc tissues.



INTELLIGENT MECHANICAL ARMS

The mechanical massager's "smart hands" continuously collect data on the curve of the back and mimic the skills of the professional masseuse to perform a multidimensional massage.

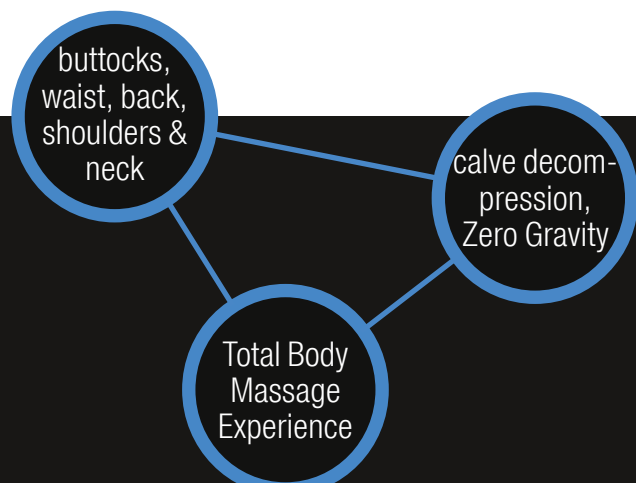

Intelligent Massage Chair

VOICE CONTROL

The intelligent voice recognition system makes it easier to control the chair.

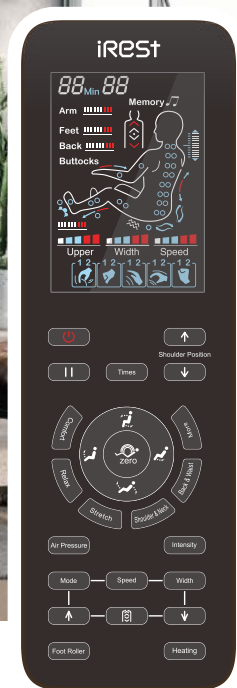

4601301

\$ 1.050,00

> Color: Brown/Beige



4601302

\$ 1.050,00

> Color: Black/Grey



Category D1

- > Programs: 12
- > Noise: ≤60dB
- > Consumption: 120W
- > Weight: 88Kg
- > Recycling tax: 4,2€



SCAN HERE

Watch the Video Presentation of the Intelligent Massage Chair AMILA 46013XX on our YouTube channel.



Shoulder & Neck Massage

Full Body Massage

Lower Limbs Massage

After 20 minutes of use, the chair stops by itself. In case of continuous use for a long period of time, the overheating fuse might automatically activate, in which case the chair will stop working for a period of 30 minutes in order for the motor to cool down.



INTELLIGENT MECHANICAL MASSAGE HANDS



The mechanical massager's "smart hands" continuously collect data on the curve of the back and mimic the skills of the professional masseuse to perform a multidimensional massage, by imitating his methods to perform sequences such as: finger presses, kneading and tapping. Thus, the mechanical arms can perform an effective massage to the cervical, thoracic and lumbar vertebra. This method can guarantee that the back can receive even a strong massage, refresh and relieve you from fatigue.

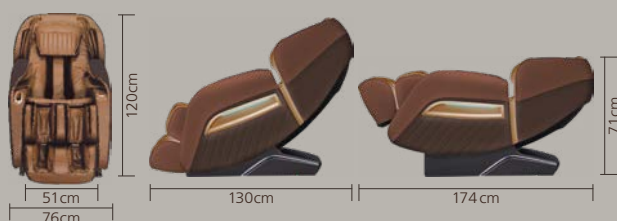

USB Charging



Bluetooth Speakers



Shortcut Keys



LED Light



Το κωνοφόρο της βόρειας Αμερικής είναι σκληρό και δύσκολο να συρρικνωθεί, φουσκώνει, στρεβλωθεί και συστραφεί. Αφού αποξηραθεί, σκουραίνει με τη λειτουργία της σάουνας, ωστόσο μπορεί να διατηρήσει το ίδιο χρώμα για χρόνια. Δεν περιέχει ρητίνη και δεν εκπέμπει οσμή. Όλα αυτά το καθιστούν συγκρίσιμο με τον κόκκινο κέδρο.



Ποιά είναι τα πιθανά οφέλη από τις Σάουνες Υπέρυθρων

από μια Συνεδρία 15 λεπτών;

- + **Αποτοξίνωση:** Η σάουνα υπέρυθρων προκαλεί διέγερση του οργανισμού και αυτός αποβάλλει με τον ιδρώτα όλες τις λιποδιαλυτές τοξίνες, βαρέα μέταλλα και τοξικές ουσίες.
- + **Ενίσχυση του Ανοσοποιητικού Συστήματος:** Η σάουνα υπέρυθρων, προκαλώντας αύξηση της θερμοκρασίας του σώματος, κινητοποιεί το αμυντικό σύστημα του οργανισμού και προκαλεί αύξηση των λευκών αιμοσφαιρίων, ενισχύοντας με τον τρόπο αυτό το ανοσοποιητικό σύστημα του ανθρώπου.
- + **Μείωση των Επιπέδων Στρες και Χαλάρωση:** Διαστέλλοντας τα τριχοειδή αγγεία βελτιώνεται η κυκλοφορία (προκαλείται υπεραίμια), ο οργανισμός απελευθερώνει τις ενδορφίνες, πράγμα που μπορεί να βοηθήσει στη μείωση των και επιπέδων του στρες.
- + **Ελεγχος Βάρους:** Αυτό δεν επιτυγχάνεται με την πρόσκαιρη απώλεια υγρών (ιδρώτας), αλλά είναι δυνατόν να επιτευχθεί και μέσω δυο κυρίως παράπλευρων δράσεων.
 - Η αποβολή των βαρέων μετάλλων σχετίζεται άμεσα με την επιτάχυνση της διαδικασίας μεταβολισμού και την αποφυγή συσσώρευσης λίπους.
 - Το κάψιμο του υποδόριου λίπους, κάτι που ισοδυναμεί με τρέξιμο 3-9 χιλιομέτρων.

ΩΣΤΗ ΕΠΑΝΑΦΟΡΑ ΜΕΤΑ ΑΠΟ ΚΑΘΕ ΑΣΚΗΣΗ

Χαλαρώστε τους μύες σας καταπραΰνοντας τους πόνους που προέρχονται από αυτούς και τις αρθρώσεις με την απελευθέρωση των ενδορφινών πρωτεϊνών ουσιών. Μειώστε την ένταση και εξαλείψτε το γαλακτικό οξύ και άλλες τοξίνες.

Η βαθιά εφίδρωση στη σάουνα μπορεί να βοηθήσει στη μείωση των επιπέδων μολύβδου, χαλκού, ψευδαργύρου, νικελίου, υδραργύρου και χημικών ουσιών - οι οποίες είναι τοξίνες που συνήθως απορροφώνται μόνο από την καθημερινή αλληλεπίδραση μας με το περιβάλλον.

Καθώς η θερμοκρασία του σώματος αυξάνεται με τη θερμότητα της σάουνας, τα αιμοφόρα αγγεία διαστέλλονται επιτρέποντας αυξημένη κυκλοφορία του αίματος, η οποία με τη σειρά της επιταχύνει τη φυσική διαδικασία επούλωσης του σώματος.

Ποια είναι λοιπόν η κατάλληλη σάουνα για εσάς;

Οι άνθρωποι χρησιμοποιούν σάουνες εδώ και χιλιάδες χρόνια, πολύ πριν μάθουμε για την ύπαρξη του φωτονίου. Για την ακρίβεια πολύ πριν τον ηλεκτρισμό. Η έκθεση στη θερμότητα έχει αποδειχθεί ένα από τα πιο ισχυρά εργαλεία για τη **διατήρηση της προσωπικής υγείας** και τη **βελτίωση της προπόνησης, της ενδυνάμωσης** και της **αντοχής**. Παρόλα αυτά, δεν υπάρχουν αξιόπιστα δεδομένα που να υποστηρίζουν ότι ένας τύπος σάουνας είναι καλύτερος από τον άλλο. Υπάρχουν μόνο δεδομένα που λένε ότι το πιο ζεστό είναι -συνήθως- καλύτερο.

Μόνο ανέκδοτες περιπτώσιολογικές μελέτες και μη ερευνημένα υποστηριζόμενα ή αξιολογημένα άρθρα που βγαίνουν συνεχώς έχουν γραφτεί.



- + **Καρδιαγγειακή Λειτουργία:** Στην προσπάθειά του το σώμα να δροσίσει τον εαυτό του, εκπνέει την κυκλοφορία του αίματος από τα εσωτερικά όργανα προς τα άκρα με την αγγειοδιαστολή. Έτσι, αυξάνονται οι καρδιακοί παλμοί, η παροχή αίματος και ο μεταβολικός ρυθμός.
- + **Βοηθά στον Ελεγχο της Αρτηριακής Πίεσης:** Με τη διαστολή των τριχοειδών αγγείων.
- + **Κυτταρίτιδα:** Η κυτταρίτιδα είναι μια ουσία σαν ζελατίνη που αποτελείται από λίπος, υγρά και απόβλητα που έχουν παγιδευτεί σε θύλακες στον υποδόριο ιστό. Η ταχεία εφίδρωση μπορεί να βοηθήσει ώστε ο οργανισμός να απαλλαγεί από την κυτταρίτιδα, ειδικότερα εάν αυτή η προσπάθεια ενισχυθεί με κατάλληλη διατροφή, μασάζ, ασκήσεις και αγωγή με ειδικές κρέμες.
- + **Καθαρισμός και Αναζωογόνηση Δέρματος:** Μια συνεδρία σε σάουνα υπέρυθρων μπορεί να βοηθήσει στο να ανοίξουν οι φραγμένοι πόροι του δέρματος και να απομακρυνθούν ρύποι, λίπη και άλλα απόβλητα του οργανισμού.

Ο καλύτερος συνδυασμός για ταχύτερα αποτελέσματα είναι η γυμναστική 1σ ώρας και έπειτα 15 λεπτά σάουνα



Λοιπόν, ναι, υπάρχουν ορισμένες περιπτώσεις ανοσοκατεσταλμένων ατόμων που χρησιμοποιούν υπέρυθρες ως συγκεκριμένη μέθοδο θεραπείας με επιτυχία. Όμως, όσον αφορά το μέσο όφελος για τη γενική προσωπική συντήρηση σε μια ρουτίνα ευεξίας, το παραδοσιακό φαίνεται να είναι καλύτερο.

Τα στοιχεία λένε ότι **βιώνετε τα οφέλη της έκθεσης στη θερμότητα σε κάθε περιβάλλον**, αλλά οι υψηλότερες θερμοκρασίες (εάν τις αντέχετε) έχουν κάποια αποδεδειγμένα πλεονεκτήματα.

Σήμερα δεν μπορούμε να πούμε ποιος είναι ο καλύτερος τύπος σάουνας, αλλά μπορούμε να πούμε ότι υπάρχει απλώς η καλύτερη σάουνα για τον καθένα από εμάς. Αυτή δηλαδή που μας αρέσει ή που μας εξυπηρετεί με βάση της ανάγκης και τους χώρους μας και θα την απολαύσουμε περισσότερο.

Σάουνα Υπερύθρων

Για τον οργανισμό μας, το να ιδρώνει είναι ο πιο ασφαλής τρόπος για να αναρρώνει και να παραμένει υγιής... και οι Σάουνες Υπερύθρων της AMILA, έχουν σχεδιαστεί για να σας χαρίζουν το πιο βαθύ, αποτελεσματικό, αποτοξινωτικό και χαλαρωτικό ιδρώμα.

Τι είναι οι υπέρυθρες ακτίνες;

Οι υπέρυθρες ακτίνες παράγονται κυρίως από τον Ήλιο και βρίσκονται στο αόρατο φάσμα των ηλιακών ακτινών, με μήκος κύματος 4-1000 Hz. Είναι απόλυτα φυσικές και, όχι μόνο είναι τελείως ακίνδυνες για τον άνθρωπο, αλλά είναι και χρήσιμες.

Τις κρύες αλλά ηλιόλουστες μέρες του χειμώνα ζεσταινόμεστε από τις υπεριώδεις ακτίνες του Ήλιου. Ακόμη και οι γνώστες σόμπες/ομπρέλες υγραερίου εξωτερικού χώρου παράγουν ένα είδος υπέρυθρης ακτινοβολίας για να μας ζεστάνουν.

Πως δουλεύει η Σάουνα Υπερύθρων

Το κύριο και ενδιαφέρον χαρακτηριστικό των υπέρυθρων ακτινών που τις κάνει χρήσιμες είναι ότι μπορούν να εισχωρήσουν βαθιά στο δέρμα έως και 5 εκατοστά. Έτσι, οι υπέρυθρες ακτίνες στις σάουνες διαπερνούν το σώμα και ωθούν τον ιδρώτα έξω από το σώμα, σε αντίθεση με τις συμβατικές που τραβούν τον ιδρώτα από το σώμα. Το σώμα θερμαίνεται από μέσα προς τα έξω, ως αποτέλεσμα της αντίκλισης που προκαλούν οι υπέρυθρες και ενεργοποιούν τα μόρια νερού και αυτά, παλλόμενα μεταξύ τους, αυξάνουν την εσωτερική θερμοκρασία. Καθώς η εσωτερική θερμοκρασία του σώματος αυξάνεται, οι τοξίνες αναγκάζονται να βγουν μέσω του δέρματος. Η θερμοκρασία μιας υπέρυθρης σάουνας είναι συνήθως μεταξύ 32°-49°C, πολύ πιο άνετα σε σχέση με μια παραδοσιακή σάουνα η οποία λειτουργεί μεταξύ 80°-104°C. Ωστόσο, παρά το ότι λειτουργεί σε χαμηλότερη θερμοκρασία, θα ιδρώνετε πολύ περισσότερο επειδή η υπέρυθρη ενέργεια διαπερνά το σώμα σας σε ένα πολύ βαθύτερο επίπεδο.

Το λίπος γίνεται διαλυτό και τελικά απομακρύνεται από το σώμα μέσω της εφίδρωσης, με αποτέλεσμα την απώλεια βάρους. Οι τοξίνες επίσης αποβάλλονται μέσω του δέρματός σας με τη βοήθεια χαμηλότερων και πιο άνετων θερμοκρασιών.

Το Ξέρατε Αυτό; *

Η σάουνα και οι θεραπευτικές της ιδιότητες ήταν γνωστές στους Φινλανδούς, Ρώσους, Τούρκους, ακόμη και Ινδιάνους της Αμερικής εδώ και 1100 χρόνια. Αυτή τη στιγμή στη Φινλανδία, σε ένα πληθυσμό 5 εκ., υπάρχουν 2 εκ. σάουνες, εκ των οποίων το 1,2 εκ. είναι σε σπίτια και οι άλλες 800.000 σε ξενοδοχεία, γυμναστήρια και club. Για ένα πληθυσμό 5 εκατομμυρίων, αυτό είναι μια μεγάλη αναλογία.

Ελάχιστη Σπατάλη Ενέργειας

Στην κλασική σάουνα, το αποτέλεσμα έρχεται με έμμεσο τρόπο. Η αντίσταση ζεσταίνει πρώτα το περιβάλλον και έτσι χάνεται το 75% της ενέργειας. Στη σάουνα υπέρυθρων, μόνο το 20% της ενέργειας χάνεται στο αέρα, ενώ το 80% χρησιμοποιείται για να θερμάνει το σώμα μας από μέσα.

* Σύγκριση Σάουνας Υπερύθρων & Συμβατικής

Σύγκριση Σάουνας Υπερύθρων & Συμβατικής	Υπέρυθρη Σάουνα	Παραδοσιακή Φινλανδική Σάουνα
Υλικό κατασκευής	Ξύλο	Ξύλο
Ασφάλεια	Πιο ασφαλής, δεν υπάρχουν θερμές επιφάνειες ή υψηλές θερμοκρασίες	Ασφαλής, με θερμές επιφάνειες
Πηγή θερμότητας	Σόμπα υπέρυθρων	Ηλεκτρικό θερμαντικό στοιχείο
Μετάδοση θερμότητας	Υπέρυθρες ακτίνες	Ζεστός αέρας
Θέρμανση σώματος	Μέχρι 7,5 εκατοστά κάτω από το δέρμα	Επιφάνεια του σώματος
Θερμοκρασία	43°- 65°C	πάνω από 80°C
Κατανάλωση ρεύματος	1 - 2,5kW	3 - 6kW
Χρόνος προετοιμασίας	20 λεπτά	30 - 90 λεπτά
Κυκλοφορία φρέσκου αέρα	Ναι	Όχι
Εξοπλισμός νερού	Δεν χρειάζεται	Ναι
Επίπεδο άνεσης	Πολύ υψηλή	Πολύ χαμηλή
Τοποθεσία σάουνας	Οπουδήποτε στο σπίτι	Η σάουνα χρειάζεται ένα δοχείο αποχέτευσης

Στα + (συν) της σάουνας υπέρυθρων είναι και τα ακόλουθα πλεονεκτήματα

- + Δε χρειάζεται ειδικό χώρο ή ειδική εγκατάσταση
- + Η χαμηλή θερμοκρασία είναι ασφαλής
- + Υψηλότερης ενεργειακής απόδοσης
- + Ομοιόμορφη θερμοκρασία στο εσωτερικό
- + Σύντομο χρόνο προθέρμανσης (15 λεπτά μονό είναι αρκετά)
- + Δέχεται CD και άλλες βελτιώσεις που κάνουν την παραμονή στη σάουνα υπέρυθρων ευχάριστη.

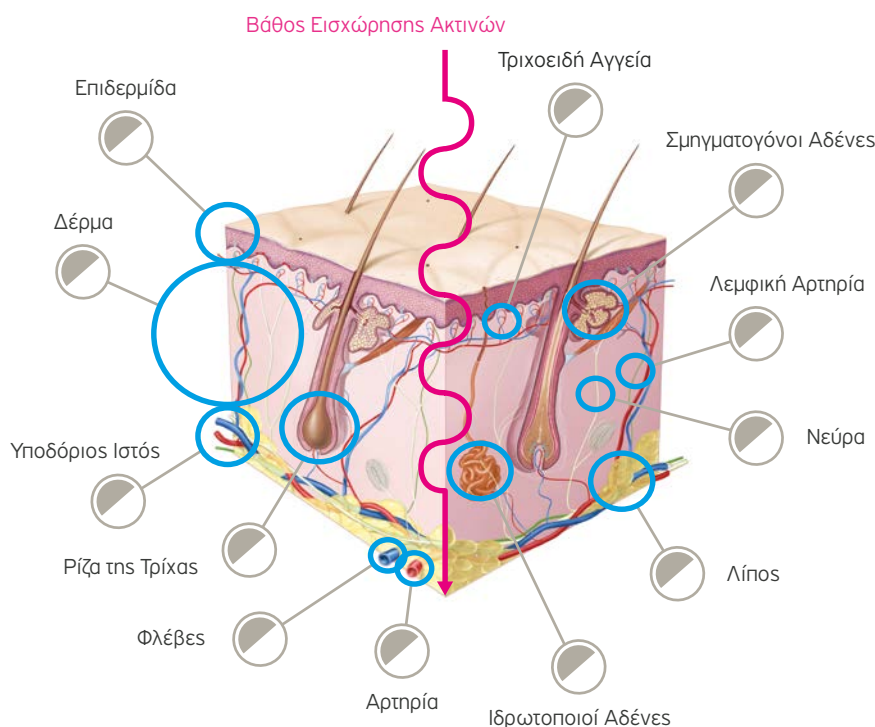

46052

- » Two-level bench
- » Wooden door handle
- » Bucket and Ladle
- » Hygrometer | Thermometer
- » Clear safety glass 6mm thick
- » 20 kg sauna stones
- » Wood: Spruce

Insulation
Covered with special waterproof fabric roof tiles



Sauna Tr4 Barrel

Traditional Sauna

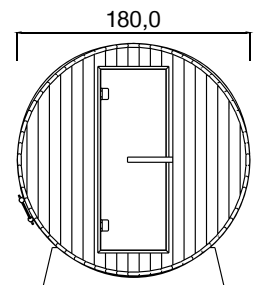
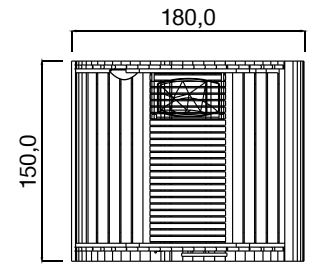

SPECIFICATIONS

Dimensions: 150,0x180,0x180,0 cm
Consumption: 4.500 W
Max. Temperature: ≈70-80°
Capacity: Up to 4
Category: D1



Dimensions
150,0x180,0x180,0 cm



Outdoor
Use



Traditional
with Stones



Capacity
3-4 People



Spruce Wood



Clear 6 mm
Safety Glass



Max. Temperature
≈70-80°

46078

\$ 1.447,00

- » One-level bench
- » Bucket and Ladle
- » Hygrometer | Thermometer
- » Clear safety glass 6mm thick
- » 20 kg sauna stones
- » Wood: Hemlock

Insulation
Added insulation on the side walls



Sauna Tr2 Oulu

Traditional Sauna

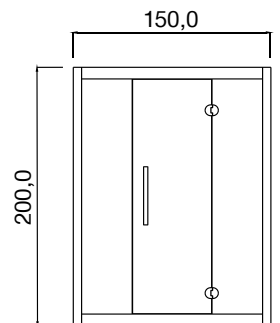
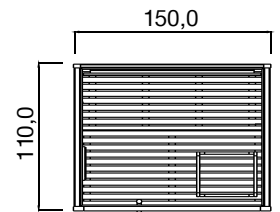

SPECIFICATIONS

Dimensions: 150,0x110,0x200,0 cm
Consumption: 4.500 W
Max. Temperature: ≈70-80°
Capacity: Up to 2
Category: D1



Dimensions
150,0x110,0x200,0 cm



Outdoor
Use



Traditional
with Stones



Capacity
2 People



Hemlock Wood



Clear 6 mm
Safety Glass



Max. Temperature
≈70-80°

Sauna Uv3 Espoo

Full Spectrum Infrared Sauna

46074

\$ 1.595,00

- » Touch screen
- » 7 color LED strip
- » Stainless steel door handle
- » Bluetooth speaker
- » Clear safety glass 6mm thick
- » Heating panel
- » Wood: Hemlock

Screen

The sauna operation is controlled by this screen, with Bluetooth and USB functions

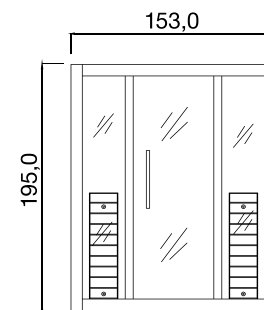
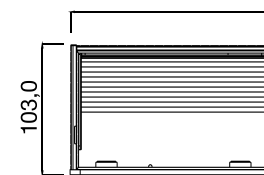

SPECIFICATIONS

Dimensions: 150,0x103,0x195,0 cm

Consumption: 2.320 W

Max temperature: ≈65°

Persons: up to 3

Category: D1



Dimensions
150,0x103,0x195,0 cm



Indoor
Use



Infrared



Capacity
3 People



Hemlock Wood



Clear 6 mm
Safety Glass



Max. Temperature
≈65°



Bluetooth
Speaker

46051

- » Touch screen
- » Bluetooth speaker
- » Clear safety glass 6mm thick
- » Heating panel
- » Wood: Hemlock

Screen

The sauna operation is controlled by this screen, with Bluetooth and USB functions

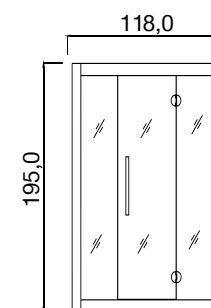
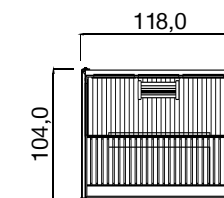
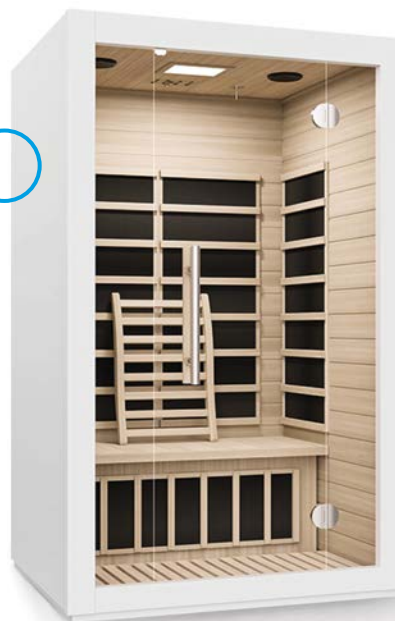

SPECIFICATIONS

Dimensions: 118,0x104,0x195,0 cm

Consumption: 1.800 W

Max temperature: ≈65°

Persons: up to 2

Category: D1



Dimensions
118,0x103,0x195,0 cm



Indoor
Use



Infrared



Capacity
2 People



Hemlock Wood



Clear 6 mm
Safety Glass



Max. Temperature
≈65°



Bluetooth
Speaker

Sauna Uv2 Salla

Infrared Sauna

46073

\$ 974,00

- » Bluetooth speaker
- » Clear safety glass 6mm thick
- » Heating panel
- » Wood: Hemlock



Screen

The sauna operation is controlled by this screen, including Bluetooth function

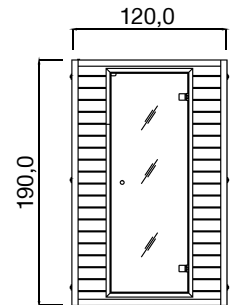
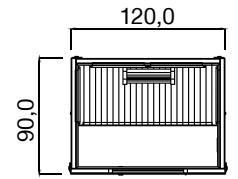

SPECIFICATIONS

Dimensions: 120,0x90,0x190,0 cm
 Consumption: 1.800 W
 Max temperature: ≈65°
 Persons: up to 2
 Category: D1



Dimensions
120,0x90,0x190,0 cm



Indoor
Use



Infrared



Capacity
2 People



Hemlock Wood



Clear 6 mm
Safety Glass



Max. Temperature
≈65°



Bluetooth
Speaker

46072

\$ 769,00

- » Bluetooth speaker
- » Clear safety glass 6mm thick
- » Heating panel
- » Wood: Hemlock



Screen

The sauna operation is controlled by this screen, including Bluetooth function

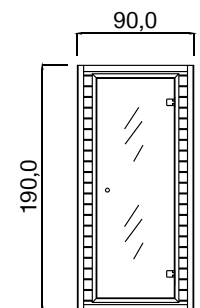
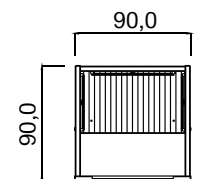

SPECIFICATIONS

Dimensions: 90,0x90,0x190,0 cm
 Consumption: 1.400 W
 Max temperature: ≈65°
 Persons: 1
 Category: D1



Dimensions
90,0x90,0x190,0 cm



Indoor
Use



Infrared



Capacity
1 Person



Hemlock Wood



Clear 6 mm
Safety Glass



Max. Temperature
≈65°



Bluetooth
Speaker

Sauna Uv1 Salla

Infrared Sauna

- ✓ Adjustable back and seat. The back can also tilt.
- ✓ My grabbing the special knob, you can change the height of the seat, without even having to stand.
- ✓ The seat/back rests are made from double density foam material: soft on top and firmer at the bottom. The unique design of the back offers the right support, while at the same time decreasing the pressure on the spine.
- ✓ Abdominal exercises.
- ✓ Aren't 90kg enough for you? Simply connect the special cables and the resistance doubles!
- ✓ The bearings, hermetically sealed and lubricated, offer extremely smooth usage.
- ✓ Design that allows placement next to a wall.
- ✓ The side arms mimic the sensation of exercising with free weights and enable the execution of special exercises for various sports.
- ✓ Adjustable position of the legs to perform the relevant exercises.
- ✓ Only *Elite* allows you to exercise with the feel of free weights, but with the safety of a multi-gym.

Elite

44723

\$ 2.002,50

MAX user weight
150 kg

Elite

44724

\$ 432,30

combined with
44723

Leg Press

Weight
50 kg

177x215(158)x210cm
(The number in parentheses is without the Leg Press)

PL weight
90/180 Kg

Weight
176 Kg

Category
D5

12 adjustments enabling the implementation of all exercises



44738

\$ 1.860,00

MAX user weight
150 Kg

GXP

44739

\$ 282,00

combined with
44738

Leg Press

Weight
45 Kg

210(165)×166×208cm

(The number in parentheses is without the Leg Press)

PL weights
19 pcs.

PL weight
90/180Kg

Weight
157 Kg

Category
D5



- ✓ Adjustable back and seat. The back can also tilt.
- ✓ My grabbing the special knob, you can change the height of the seat, without even having to stand.
- ✓ The seat/back rests are made from double density foam material: soft on top and firmer at the bottom. The unique design of the back offers the right support, while at the same time decreasing the pressure on the spine.
- ✓ Abdominal exercises.
- ✓ Aren't 90kg enough for you? Simply connect the special cables and the resistance doubles!
- ✓ The bearings, hermetically sealed and lubricated, offer extremely smooth usage.
- ✓ Design that allows placement next to a wall.
- ✓ The side arms mimic the sensation of exercising with free weights and enable the execution of special exercises for various sports.

12 adjustments
enabling the
implementation
of all exercises

X-Press PRO



X-Press PRO

12 adjustments enabling the implementation of all exercises

44742

\$ 1.448,00

- > Adjustable back and seat, the back can also tilt, from high density foam material, 5 cm thick
- > **Frame:** 5x5 & 5x7,5 iron tubes
- > **Pulleys:** Diameter 11,5cm, nylon and fiberglass, with hermetically sealed and lubricated bearings
- > **Cable:** Extremely flexible, nylon covered, more than 900kg endurance
- > **Weights:** 20 pcs. iron plates with nylon bushings
- > **Guides:** Chromed 2.5 cm

Semi-Commercial Grade

PL weights 19 pcs. PL weight 90 Kg

Weight 150Kg Category F1

MAX user weight 150 Kg

144,0x210,0x210,0cm

44736

\$ 1.385,00

GX

> **WITHOUT** the Leg Press

MAX user weight 150 kg

- ✓ Adjustable back and seat. The back can also tilt.
- ✓ Abdominal exercises.
- ✓ The bearings, hermetically sealed and lubricated, offer extremely smooth usage.
- ✓ Design that allows placement next to a wall.

Semi-Commercial Grade

> Leg Press



12 adjustments enabling the implementation of all exercises

44737

\$ 338,00

Leg Press

combined with 44736

Weight 36,4 Kg

188(180)x192(163)x212cm
(The number in parentheses is without the Leg Press)

PL weights 14 pcs. PL weight 90-95 Kg Weight 130Kg Category D5

44743

\$ 989,00

Semi-Commercial Grade

GL

IFHC

\$ 480,00

Half Cage

IFHC

► Adjustable back and seat. The back can also tilt



MAX user weight
150 Kg

PL weights
19 pcs.

PL weight
90 Kg

Weight
101 Kg

Category
D5

133,3×114,3×210,8cm



Weight
100 Kg

Max Weight
200 Kg

Category
F1

169×173×209cm

IFHCL

\$ 293,00

Half Cage Lat Attachment

IFHCL

IFHCS

\$ 263,00

Half Cage Smith Attachment

IFHCS

IFHCP

\$ 157,50

Half Cage Pec Fly Attachment

IFHCP



Weight
41 Kg

Category
F1

180×40×210cm



Weight
33 Kg

Endurance
200 Kg

Category
F1

195×30×173cm



Weight
24,3 Kg

Category
F1

95×36×154cm

44710

\$ 2.390,00

JONES PLATINUM

For the person insisting only for the best! In contrast to a typical Smith machine, Jones Platinum offers patented technology, allowing horizontal and vertical movement. The addition of Active Balance bar offers a truly unique free-bar experience.

- Safety spotters that move with you
- Entirely natural feeling
- Use the Olympic bar of your choice
- Many accessories available
- 5 different traditional Smith exercises

The **Full Body Trainer (FBT)** dual cable columns provide for the very best Functional Training, Sports Specific Training and Body Building exercises. The FBT combined with the Jones Platinum offers an almost infinite number of adjustments and exercises. The FBT can be used as a traditional Functional trainer, or can be used in concert with the Jones Platinum to offer a multitude of Stretch Training exercises, Body Weight exercises or Progressive Functional Training exercises™. Progressive Functional Training allows for adjustable degrees of muscular involvement, from engaging the entire body, to isolating specific muscle groups.

FEATURES

- **Body Weight Training:** Two different chin bars (multi-angle in the front and straight bar in the rear) provide every possible grip for chin-ups and pull-ups. Fix the Olympic Bar into various positions for angled push-ups, pull-ups, leg exercises and more. The Jones Platinum will accept your own Hanging Ab Straps, or Adjustable Training Straps.
- **Stretch Training:** The bars and handles can be fixed into dozens of positions for a myriad of stretches.
- **Functional Training:** The FBT is a Full Body Training machine providing Strength training for the way humans are designed to move! Dual weight stacks provide up to 200 pounds of combined resistance and 80 inches of travel.
- **Progressive Functional Training:** Combining the Jones Platinum and the FBT enhances the variety of exercises that can be performed.
- **Barbell Training:** All Barbell Exercises can be performed with the safety of the bar hooks and safety spotters moving along with you!
- **Sports Specific Training:** The FBT also provides Sports Specific training.
- **Smith Machine Training:** The Jones Platinum can be locked into place to become a Smith Machine.



Category
F1



44711

\$ 1.590,00

FBT (FULL BODY TRAINER)

- Adds hundreds of exercises to Jones
- 32 different height settings for the grips
- Progressive functional training
- Accessories: Long bar, Multi-position handles, Add-on weights, Optional progressive functional pad

Category
F1

SPECIFICATIONS

- **Construction:** Heavy duty steel
- **Movement:** All moving parts utilise industrial quality linear LM25 bearings and bars of hardened steel
- **Active Balance Bar:** From 25 until 454 kgs strength
- **Dimensions:** 137x215x213cm or, with the addition of FBT, 188x215x213cm

44712

\$ 1.795,00

- **At any point** during an exercise the weight bar can be “racked” with a simple twist of the wrist. Adjustable safety spotters are included to add that extra measure of security
- **Easy Transitions:** Simply raise or lower the bar to the desired starting position, adjust the safety spotters to a safe position, add the desired weight, and lift!
- **Hooks and safety spotters** travel with you
- **Can be locked** for traditional Smith Machine exercises
- **Includes Chin-Up Bar**



44713

\$ 364,40

- **PLATE RACK**
 - Bolts directly onto the back
 - Features a total of 12 solid chrome Olympic weight Holders



- > **11 Lockout positions** for hooks and safety spotters at 4½” intervals
- > **Movement:** All moving parts glide smoothly on industrial grade linear bearings and solid hardened steel guide rods
- > **Choose** the Olympic Bar you want



156,2x213,3x210,8cm

MAX user weight 150 Kg Weight 230 Kg Category F1

44714

\$ 1.399,00

- > **11 Lockout positions** for hooks and safety spotters at 4½” intervals
- > **Movement:** All moving parts glide smoothly on industrial grade linear bearings and solid hardened steel guide rods
- > **Choose** the Olympic Bar you want

- **Includes Chin-Up Bar**
- **Can be locked** for traditional Smith Machine exercises

Additional optional parts



4471402

\$ 1.185,00

- **CROSSOVER**
 - Two independent 200lb weight stacks provides 2:1 ratio
 - 18 different cable positions on each column
 - Provides hundreds of different exercises
 - Includes ankle strap and two single handles
 - Weight stack guards included

4471401

\$ 620,00

- **LAT OPTION**
 - 200lb weight stack provides 1:1 ratio
 - High-pull and low-pull station
 - Weight stack guards included
 - Includes Lat-Pull Bar and a Curl / Row Bar



44713

\$ 364,40

- **PLATE RACK**
 - Bolts directly onto the back
 - Features a total of 12 solid chrome Olympic weight Holders



87,0x138,0x210,0cm

MAX user weight 150 Kg Weight 174 Kg Category F1

44741

\$ 1.049,50

The most Affordable member of the Jones family

Our patented barbell motion provides for an almost unlimited array of exercises. Smith Machines only move vertically, not allowing for natural body movement. The Jones moves both vertically and horizontally, allowing for unlimited, user-defined motion. Because the body's natural movements can be utilized within the Jones, all free weight exercise can be performed. The Jones Freedom comes standard with a bar.

- **At any point** during an exercise the weight bar can be "racked" with a simple twist of the wrist. Adjustable safety spotters are included to add that extra measure of security
- **Easy Transitions:** Simply raise or lower the bar to the desired starting position, adjust the safety spotters to a safe position, add the desired weight, and lift!
- **Hooks and safety spotter** travel with you
- **Can be locked** for traditional Smith Machine exercises



- > **Olympic bar**, 40lbs weight, capacity of 500lbs
- > **20 Lockout positions** for bar and safety spotters with 3 inch spacing
- > Commercial grade precision **linear bearings** for smooth action
- > Case-hardened, precision milled stainless steel **guide rods**
- > **Dark gray** powder coat finish



107,0x220,0x211,0cm

MAX user weight
150 Kg

Weight
106 Kg

Category
F1

44715

\$ 1.235,00

Combine three machines into one!

Foot press and Hack-Donkey Squat with a maximum load of 454kg

F660 (Linear Bearing Hip Sled)



- > **Squat shoulder pads:** Unlike other machines, our oversized squat shoulder pads are fully adjustable, accommodating a wider range of users
- > **Foot Plates:** Both upper and lower foot plates adjust to several different angles. Upper plate measuring 16" L x 24" W and lower measuring 17" L x 24" W
- > **Donkey Squat Pad:** Allows for squats and calf raises by pressing with lower lumbar, relieving spinal compression
- > **Industrial grade linear bearings:** Never flatten and are next to impossible to wear out, ensuring smooth consistent performance for as long as you own the machine
- > **Space saving design:** With weights loading under the carriage
- > **Construction:** Using heavy gauge, 2" x 3" steel tubing and 1/4" plate steel
- > **Carriage:** Rides on industrial grade Linear Bearings, and 1.25" case hardened steel solid guide rods. 75 lb. starting weight
- > **All pads:** Use double stitched heavy duty upholstery and high density foam
- > **Leg press back pad:** Features lumbar support and flips up on a hinge for hack squat
- > **Squat, Shoulder and Leg Press pads:** Permanently attached for convenience and longevity
- > **Diamond skid hack squat plate:** Allows for multi-position foot placement and can be adjusted to 5 different angles
- > **Weight Capacity:** 454kg



Weight
70 Kg

Capacity
454 Kg

Category
F1

200,6x99,0x127,0cm

44709

\$ 1.830,00

Commercial Grade

- > **Tube:** Oval 8,26x4,45mm
- > **Pulleys:** Ø10cm fiberglass with sealed bearings
- > **Cables:** Nylon covered, capable to endure more than 900kg
- > **Weights:** 2 autonomous columns covered with acrylic panels, 72.5kg each, offering resistance in relation to the chosen weight of ratio 2:1
- > **Guides:** Chromed Ø2,54cm
- > **Accessories:** Exercise book, Long bar, Short bar, Pull bar, Pull straps, Abdominal harness, Ankle straps, Single grips

+ Amazingly smooth movement



- > Pulleys that rotate 180 degrees and follow the movement of the body for even more natural movement.
- > The pulleys are adjustable throughout the whole height range, so that you can immediately switch to another exercise with easy and quick change of the height of the pulley using just one hand

Category F1



Dual Adjustable Pulley PFT



- > 145kg weight plates divided into 2 autonomous columns of 72.5kg each

211x135x102cm

44717

\$ 1.298,00

Semi-Commercial Grade

- > **Tube:** Oval 8,26x4,45mm
- > **Pulleys:** Ø9cm fiberglass with sealed bearings
- > **Cables:** Nylon covered, capable to endure more than 900kg
- > **Weights:** 2 autonomous columns covered with acrylic panels, 90kg each, offering resistance in relation to the chosen weight of ratio 2:1
- > **Guides:** Chromed Ø2,54cm
- > **Accessories:** Exercise book, Long bar, Short bar, Triceps rope, Pull bar, Pull straps, 2 chains, Ankle straps, Single grips



Dual Adjustable Pulley HFT



MAX user weight 150kg | Weight 101kg | PL weights 2x90kg | Category F1

102,2x142,0x208,0cm

44746

\$ 954,60

Wall-mounted Double Pulley "Tug"

Cables

The PU coating on the 5.6 mm diameter cables increases strength and safety

Storage hooks

Support bar with special coating for better grip and precision when performing exercises, as well as integrated storage hooks for grips and accessories

Pulleys & Guide rods

The aluminum pulleys that can be adjusted to 28 height positions, combined with 19mm aluminum guide rods, ensure extremely smooth and quiet operation. The 1:2 weight ratio offers controlled loading, ideal for both strength training and rehabilitation

Wall-mounted

Wall mounting drastically reduces space requirements

SPECS

Dimensions: 221,0x107,0x28,0 cm

NET weight: 276 kg

Plates: Metal

Pulleys: Aluminum

Guide rods: 19mm aluminum

Weight plates: 2 x 90kg, 5kg/plate

Weight ratio: 1:2

Category: F2

91640

\$ 1.230,00

Semi-Commercial Grade

Dual Adjustable Pulley FT3100

> **Tube:** 40x80x2.0mm heavy duty construction tube

> **Cables:** 2000lbs tensile strength aircraft cables

> **Weights:** 2 x 50kg commercial grade steel stack

> **Max user weight:** 180kgs

> **Accessories:** Long bar, Short bar, Triceps rope, Pull grips, 3 chains, Single grips, Soft grips



Weight
234kg

Category
F1

105x188x223cm

44733

\$ 837,00

CFT

EXTREMELY COMPACT, FULL BODY STRENGTH TRAINING

- The Dual Pulleys move up and down on a counter-balanced system and are positioned in a wide format
- 4:1 cable ratio for smooth action and greater range of motion make this machine ideal for Speed Training

FEATURES

- Functional Trainer Accessories: Poster, 2 Single Handles, Ankle Cuff, and 2 Chains.
- Functional Trainer Cable Column Pulley: Independent, counterbalanced adjustable cable column pulleys with 32 height positions that rotate allowing you to train from every angle and any height.
- Compact: Can be placed in any corner of the room.
- Construction: Oval/Round heavy gauge steel tubing, tough diamond gray and textured black powder coated finish, sleek laser cut plates, chrome uprights, laser etched, and attention to the smallest details all add up to an overall exceptional aesthetic appearance.
- Cables: The cable travels 180" when using a single pulley or 90" when using both, and are constructed of flexible nylon coated, 7 X 19 strand aircraft cable rated at over 2000 lbs. tensile strength.
- Pulleys: 3.5" diameter, fiberglass impregnated nylon pulleys with sealed ball bearings.
- Guide Rods: Chrome plated 1" diameter tubular steel.
- Warranted for: Light Commercial and home use.
- Weight Stack: 200lbs. The weight stack to user weight ratio is 4:1 providing up to a total of 37.5 lbs. resistance allows for extremely smooth action, 2.5lb increment weight increases, and greater range of motion. Connect both Cables together with the included chains for up to 75lbs of resistance. (100lbs with the add-on weight)



125,6×100,1×209,6cm

Weight 71kg PL Weights 90kg Category F1

44732

\$ 689,00

CPS

THE MOST COMPACT OF ALL

- The Dual Pulleys move up and down
- Suitable for any small area
- 4:1 cable ratio for smooth action and greater range of motion make this machine ideal for Speed Training
- Connect both pulleys with the included chain for a 2:1 cable ratio

FEATURES

- Easy accessibility; also suitable for wheelchair users
- Bracket frames are integrated to drill on the wall for more stability
- Functional Trainer Accessories: 2 Single Handles, Ankle Cuff
- Pulleys: Ball bearings for smooth power transmission, can be adjusted in 32 different positions and rotate fully so that you can actually move from any angle at any height
- Weight Stack: 200lbs. The weight stack to user weight ratio is 4:1 providing up to a total of 37.5 lbs. resistance allows for extremely smooth action, 2.5lb increment weight increases, and greater range of motion. Connect both pulleys together to double resistance



53,6×60,7×202,7cm

Weight 51kg PL Weights 90kg Category F1

Power Rack F430 / Rowing machine

BODYCRAFT

44718

\$ 472,00

The BodyCraft Power Rack is built for the person who knows how to push their body to the limit. Rugged construction and easy adjustments make your workout enjoyable and quick. Adjustable Spotter Arms are included for safe, solo workouts.



Chin bar: Allows for use with inversion boots, hanging ab straps, bands, etc. (capacity: 150kg)



J-hooks and Spotters: High-density rubber securely screwed down, prevents scratching

Frame: Rugged heavy gauge 50x75mm steel tubing, 3mm thick

Pop-pins: Easy to adjust and always out of the way of your bar

Working space: 109x87,5cm



2" spacing between each adjustment point, laser-etched numbers

MAX user weight
150kg

Weight 87kg Capacity 450kg Category F2

130,8x124,2x209,5cm

44735

\$ 170,00

- > **Material:** Powder-coated steel
- > **Track:** Heavy duty steel mono-rail beam
- > **Foot hold:** Fixed steel footrest with velcro foot straps
- > **Support legs:** Steel legs with end-caps to protect your floor and prevent movement
- > **Seat:** Contoured comfort seat with heavy duty roller bearings, 26,25-31,50cm height
- > **Seat movement:** 100cm
- > **Max user height:** 195cm
- > **Max user weight:** 150kg

Power Strength Row

Connects to existing low-cable

- **IT MUST BE CONNECTED** to an existing low-cable
- It allows for **faster** and **smoother reps** for an increased cardiovascular workout
- **High-performance** easy glide **seat wheels** for smooth long-lasting performance
- **Transport wheels** allow for easy placement and storage



Weight 15,3kg Category F1

176,8x50,6x32,0cm

RFT Functional Trainer

(For F430 Power Rack)

44729

\$ 1.190,00

- > **Frame:** Heavy gauge oval steel tubing. The powder coated finish evenly coats all surfaces, tough and long lasting.
- > **Pulleys:** Diameter 8,9cm, fiberglass impregnated nylon pulleys with sealed ball bearings
- > **Cable:** The most flexible nylon coated, 7 x19 strand aircraft cable rated at over 900 kg tensile strength

Our Rack Functional Trainer (RFT) option is built for MAXIMUM flexibility and safety. Expand the exercises that you can perform with your F430 Power Rack by adding this 6 Pulley Option.

Virtually every strength training option is available with this versatile and compact system. The 6 swivel pulleys allow for movement along multiple planes, and dual weight stacks greatly increase the number of exercises that can be performed.



BRING IT DOWN – The RFT features dual independent swiveling high pulleys mounted at the top rear of the back. These can be used in conjunction with the included lat bar or single handles. Work your shoulders, back, arms and more!



Accessories:
Long lat bar, Row/curl bar, Ankle strap, 2 single handles, 2 chains



FUNCTIONAL FRONT – Dual front adjustable swiveling pulleys with 23 height positions. Adjust the pulley height by simply releasing the pop-pin and sliding the pulley to the desired position. The laser etched numbers on the inside of each upright will make sure both pulleys are at equal heights.

Guide rods:
Chrome plated 2,54cm diameter tubular steel



Weight stack:
Dual 91kg each, with magnetic selector pins and stack to user weight ratio being 2:1



GET LOW – In the rear of the RFT are dual independent low pulleys. This station is ideal for rows, bicep curls, ab exercises, etc.



Weight 270kg Category F2

165,1 x 149,9 x 211,4cm

Super Gym 1

44727

\$ 1.569,00

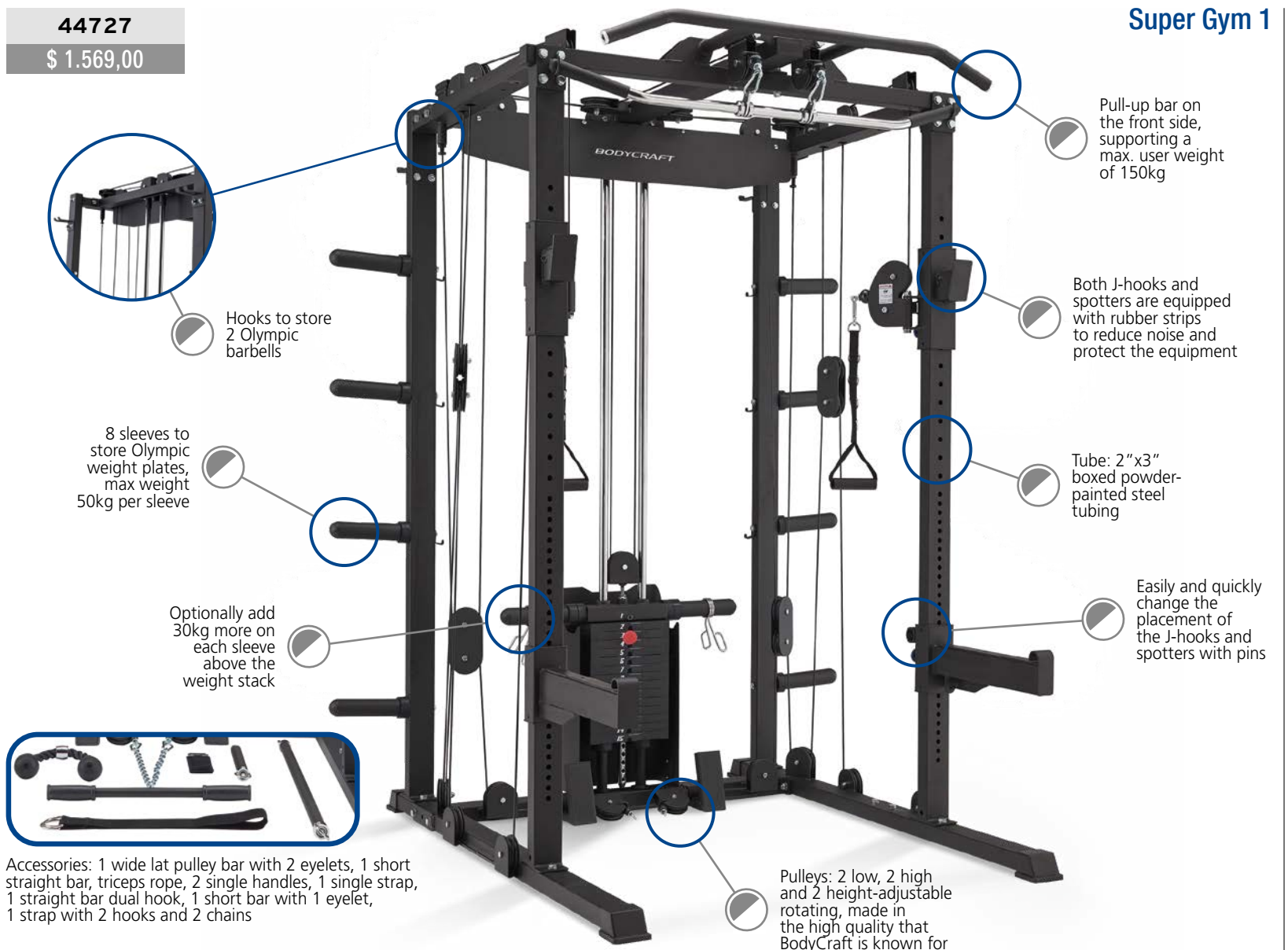

Pull-up bar on the front side, supporting a max. user weight of 150kg

Both J-hooks and spotters are equipped with rubber strips to reduce noise and protect the equipment

Tube: 2"x3" boxed powder-painted steel tubing

Easily and quickly change the placement of the J-hooks and spotters with pins

Hooks to store 2 Olympic barbells

8 sleeves to store Olympic weight plates, max weight 50kg per sleeve

Optionally add 30kg more on each sleeve above the weight stack

Pulleys: 2 low, 2 high and 2 height-adjustable rotating, made in the high quality that BodyCraft is known for



Accessories: 1 wide lat pulley bar with 2 eyelets, 1 short straight bar, triceps rope, 2 single handles, 1 single strap, 1 straight bar dual hook, 1 short bar with 1 eyelet, 1 strap with 2 hooks and 2 chains

Weight	Stack	Capacity	Category
239Kg	90Kg	360Kg	F2

166x183x212cm

44783

\$ 592,00

Smith

- Barbell included: 20kg weight, 214cm long, 28mm diameter, 400kg capacity, 7" long Olympic size weight holders
- 20 lockout positions for bar and safety spotters with 3" spacing

This attachment turns your SG1 into a true Smith Machine. Easy to assemble, with the quality that BodyCraft is known for. The barbell is mounted on bearings to ensure smooth rotation. You may also change the height of the safety spotters on each side.

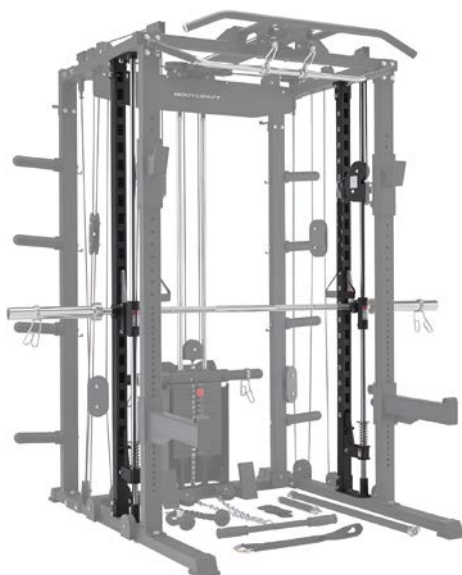

44781

\$ 175,20

Spot Adjuster

Simply lift the bar and the J-hooks will fall back into place, you will not have to make that extra step backwards.



44782

\$ 18,90

Battle Rope Ring

The battle rope stays better in place than if you were to place it around one of the uprights.



44784

\$ 29,30

Landmine

You can add many exercises to your program. Maintenance-free. Accepts Olympic-type bars.



44706

\$ 189,00

Commercial Grade

Bench F320

- > **Tube:** Square 50x75mm
- > **Pillow:** 5cm high density foam material for support, 1,25cm low density foam material on the top for comfort
- > **Incline:** 8 positions (20°, 0°, 15°, 30°, 38°, 45°, 60°, 70°)
- > **Height:** 51cm when horizontal, making him ideal for exercises with dumbbells



Weight 29,5kg Capacity 450Kg Category F1

159,0x53,2x50,8cm

44701

\$ 68,00

Arm Curl Attachment
Suitable for both of the benches above

- Ergonomically designed comfort pad
- Pop-pin Adjustable Bar Catch (Can be removed for certain applications)

44708

\$ 210,00

Commercial Grade

Bench F602

- > **Tube:** Square 50x76mm
- > **Pillow:** High density foam material inside, 5cm thick offering support, topped with low density 1,25cm thick foam material for added comfort
- > **Incline:** 7 positions
- > **Endurance:** 450kg

- Transport wheels



Weight 32,8kg Capacity 450Kg Category F1

62,0x157,0x49,6cm

44702

\$ 66,20

Leg Curl/Extend Attachment
Suitable for both of the benches above

- Locking leg hold down
- 6 roller design
- Weight peg accepts standard (Ø28mm) disks



44707

\$ 232,00

Commercial Grade

Bench F603

The ideal complement to PFT

- > **Tube:** Square 50x76mm
- > **Pillow:** 5cm high density foam material for support, 1,25cm low density foam material on the top for comfort
- > **Incline:** 8 positions (0°- 85°)

- Transport wheels
- Its low height (46cm) makes him ideal for exercises with dumbbells
- The back can be adjusted vertically (8 positions)



71,2x99,1x40,7cm

Capacity 350Kg Weight 27,7 Kg Category F1

44716

\$ 205,00

F670 (Roman Chair With Hyperextension)



130,0x61,0x94,0cm

- > **Construction:** 2" x 2" square, heavy-gauge steel
- > **Incline:** Adjusts from 0, to 25, to 45 degrees
- > Fully adjustable Πλήρως ρυθμιζόμενα foam pads and foot plate
- > Fully adjustable roman chair, accommodated all size users
- > Extra wide injection molded pad is comfortable for both men and women
- > Exercise guide included for your convenience
- > Handle bars for safe entry and exit

Weight 25,6 Kg Capacity 120Kg Category F1

44704

\$ 179,00

Commercial Grade

Bench F680

- > **Tube:** Square 50x50mm
- > **Pillow:** 5cm high density foam material for support, 1,25cm low density foam material on the top for comfort
- > **Incline:** 16 positions (19°-46°)

- Rotating caps for easy transport



Capacity 120Kg Weight 20,6 Kg Category F1

109,3x71,3x43,2cm

IFFID
\$ 199,00

Multi-Purpose Bench

IFFID

Semi-Commercial Grade



Weight 33 Kg
Category F1

158x65x52cm

IF45
\$ 155,00

45-Degree Hyperextension

IF45

Semi-Commercial Grade



Weight 23,5 Kg
Category F1

121x74x77cm

IFAAB
\$ 141,00

Adjustable Abdominal Bench

IFAAB

Semi-Commercial Grade



Weight 24 Kg
Category F1

168x57x115cm

IFRC
\$ 163,90

Roman Chair

IFRC

Semi-Commercial Grade



Weight 30,5 Kg
Category F1

136x74x109cm

IFAC
\$ 109,00

Abdominal Crunch
IFAC

**Semi-Commercial
Grade**



Weight
17 Kg

Category
F1

110x48x58cm

IFFB
\$ 118,00

Flat Bench
IFFB

**Semi-Commercial
Grade**



Weight
19,5 Kg

Category
F1

131x53x49cm

IFUB

\$ 96,00

Utility Bench

IFUB

Semi-Commercial Grade



Weight
12,7 Kg

Category
F1

86x60x87cm

IFSPC

\$ 141,00

Seated Preacher Curl

IFSPC

Semi-Commercial Grade



Weight
24,7 Kg

Category
F1

102x71x82cm

IFPT

\$ 383,00

Power Tower

IFPT

Semi-Commercial Grade



Weight
77 Kg

Category
F1

132x61x211cm

93701

\$ 178,00

Semi-Commercial Grade

Seated Calf Raise Machine

- Adjustable over-sized pads.
- Easy pull pin to adjust height and distance in seconds.
- Laser cut checker foot plate enables different start positions.
- Adjustable knee pad for correct alignment during your exercise.
- Can use Standard and Olympic Weight plates - comes with a weight plate adapter.
- Includes built in safety catches for added safety during your workout.



Category F1

127x52x45cm

93702

\$ 191,20

Semi-Commercial Grade

Adjustable Hyper Extension

- Easy pull-pin to adjust height and distance in seconds.
- Made to suit all user heights.
- Fully adjustable from 45° to 90° for optimal results and correct alignment during your exercise.
- Adjustable foot holders for correct positioning.



Category F1

150x93x96cm

93703

\$ 299,90

Semi-Commercial Grade

Leg Extension

- Adjustable over-sized pads.
- Adjustable and removable leg hold-down rollers to give you maximum comfort.
- Easy pull-pin adjustment to switch from leg extension to leg curls in seconds.
- Laser cut range-of-motion adjustments enables multiple start positions.
- Includes a lock catch to enable legs to be locked in place for abdominal workouts.
- Can be used with both Standard and Olympic Weights.



Category F1

160x127x128cm

93704

\$ 256,00

Semi-Commercial Grade

Adjustable Olympic Bench Press

- Made from high quality materials, ensuring durability and comfort
- It allows for decline, flat and incline bench press.



Category F1

150x125x147cm

93707

\$ 241,50

Semi-Commercial Grade

Vertical Knee Raise Dip Pull-Up Station

AMiLA®

- Gives you the ability to do chin-ups, dips, push-ups, sit-ups and leg raises
- Angled back pad for added comfort whilst performing leg raises
- Multiple grip positions for pull-ups, dips and push-ups
- Contoured arm rests for secure positioning
- Leg holder for solid ab workouts and sit-ups



Category F1

158x125x211cm

44274

\$ 211,20

Semi-Commercial Grade

Power Tower

AMiLA®

- > **Tube:** 50x70x1.5mm
- > **Pillow:** EPE inside, covered by 1mm PU



Weight 41 Kg

Category F1

112x112x221cm

44273

\$ 150,20

Chin-up Rack

HOME USE

AMiLA®

- > Absolutely stable



Weight 35 Kg

Category D7

136x108x217cm



Home Gym HG1200

91204

\$ 446,40

- > **Tube:** 50x50x1.5mm heavy duty construction tube
- > **Seat wood:** 12mm thick
- > **Seat pad:** 50mm thick
- > **Back pad:** 50mm thick
- > **Cables:** 2000lbs tensile strength aircraft cables
- > **Weights:** 205LB vinyl weight stack (13pcs x 15lbs + 1pc x 10lbs)
- > **Max user weight:** 135kgs



Includes a wide variety of grips/handles/bands to meet all your training needs

Weight
150kg

Category
D7



SCAN HERE  to view the Assembly Video on our YouTube channel.



Multiple functions of the pec deck

By adjusting the **pec deck** to the proper position, you can use it for **chest presses** and **back pulls**, taking advantage of all the different functions that the **HG1200** gives you.



183,2×106,9×213,9cm

91202

\$ 287,00

- > **Tube:** 50x50x1.5mm heavy duty construction tube
- > **Cushions:** 5cm thick
- > **Cables:** 2000lbs tensile strength aircraft cables
- > **Weights:** 148LB vinyl weight stack (14pcs x 10lbs + 1pc x 8lbs)
- > **Max user weight:** 125kgs

Leg-Press – Preacher-Pad

The AMILA HG1187 Multi-Gym allows you to choose between using a preacher-pad or leg-press on the front, the one that you are not currently using can be placed on the receptacle at the back.



SCAN HERE to view the Assembly Video on our YouTube channel.

You can use the Pec Deck to perform chest presses by locking it in place using a safety pin.

Home Gym HG1187

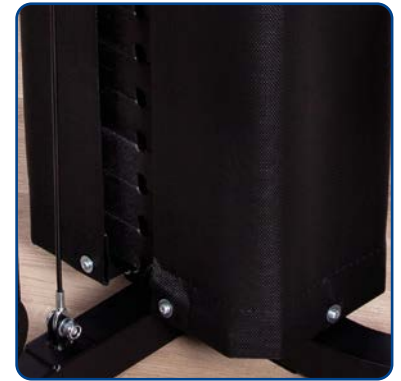

EXTRA HANDLES/GRIPS

Extra handles/grips are included, in order to meet all your training needs.

104×186×202cm



Weight **125kg** Category **D7**

91203

\$ 232,00

- > **Tube:** Ø60mm
- > **Weights:** 98Lbs
- > **Seat wood:** 12mm thick
- > **Seat pad:** 50mm thick
- > **Seat dimensions:** 35x40cm
- > **Seat height:** 47cm
- > **Back pad:** 50mm thick
- > **Back dimensions:** 29x62cm
- > **Butterfly arms max width:** 94cm
- > **Lat bar max height:** 180cm
- > **Max user weight:** 125kgs



SCAN HERE to view the Assembly Video on our YouTube channel.

Home Gym HG187F



Weight **87kg** Category **D7**

133×104×201cm

Home Gym HG250

91210

\$ 179,90

- > **Tube:** 45x1.5mm heavy duty construction tube
- > **Cushions:** 5cm thick
- > **Cables:** 2000lbs tensile strength aircraft cables
- > **Weights:** 44,5kg (10pcs)
- > **Max user weight:** 120kgs



SCAN HERE  to view the Assembly Video on our YouTube channel.



Category D7

Home Gym HG400

91208

\$ 309,90

- > **Tube:** 50x50x1.5mm heavy duty construction tube
- > **Seat wood:** 12mm thick
- > **Seat pad:** 50mm thick
- > **Back pad:** 50mm thick
- > **Weights:** 138LB vinyl weight stack
- > **Max user weight:** 125kgs



SCAN HERE  to view the Assembly Video on our YouTube channel.

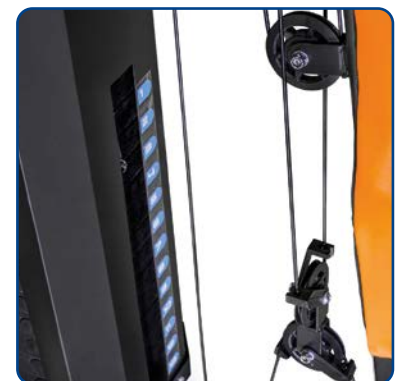

Weight 113Kg

Category D7

170x100x198cm

46437

\$ 20,40

- > **Designed for:** Full 360 degree rotation
- > **Safety:** It is recommended to use at least one 20kg disk or more
- > **Compatibility:** Olympic disks - Olympic bars
- > **Material:** Iron

*The pictured bumper plate is not included

SPECIFICATIONS

NET weight: 4,5 kg
Category: F1



Post Landmine

AMILA Post Landmine offers a portable solution without any restrictions, offering a full 360 degree rotation for athletes, coaches and people trying to save space while training. Insert the Post Landmine in a bumper plate's hole or any other Ø50 Olympic type disk and begin your workout with safety.

46432

\$ 99,90

SPECIFICATIONS

Category: F1

Renegade Stand

Bar stand used when inserting disks for Landmine Pivot 360°



46107

\$ 69,90

* The pictured bumper plates are not included

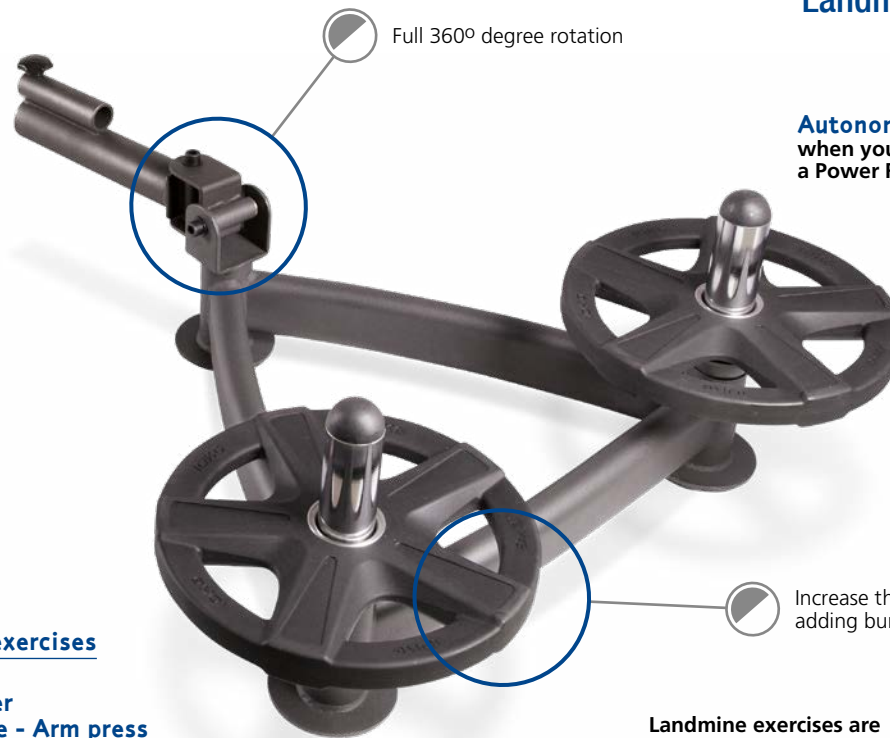
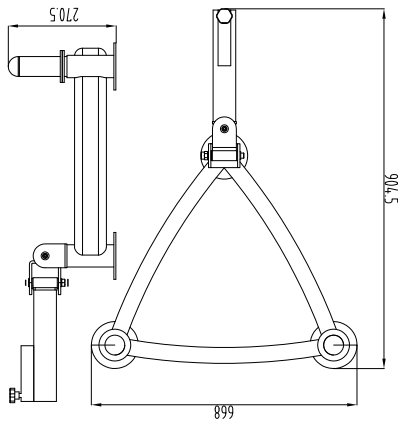

Landmine Pivot 360°

Autonomous Landmine, when you don't have a Power Rack

5 basic Landmine exercises

- Landmine Squat
- Landmine Thruster
- Rotational Single - Arm press
- Landmine Antirotation
- Split Squat - Row combo

Landmine exercises are more gentle than barbell exercises and effectively exercise all muscle groups.

SPECIFICATIONS

NET weight: 14 kg
Category: F1

46433

\$ 117,50

Wishbone



46434

\$ 64,70

Clean & Jerk



46439

\$ 35,90

Wide grip



46438

\$ 29,90

Narrow grip



46440

\$ 14,00

Single grip



Landmine Grips

46110

\$ 127,00

- > One antiskid handle, 25mm diameter
- > Big disk receptors
- > 4 stabilizers
- > Distance between handles: 70cm
- > **Frame:** 50x50x3mm

+ High endurance for many years of professional use



Weight 24 Kg Category F1

168x80x29cm

Hex Trap «Grym»

Single Grip

46142

\$ 198,00

- > One antiskid handle, 32mm diameter
- > Big disk receptors, 41cm length
- > Distance between handles: 63,5cm
- > **Frame:** 38x38x3mm

+ High endurance for many years of professional use



Weight 27,2 Kg Category Φ1

225x72x22cm

Hex Trap Bar

Single grip

46101

\$ 142,10

- > Three rotatable antiskid handles of different diameters
- > Big disk receptors
- > 4 stabilizers
- > Distance between handles: 70cm
- > **Frame:** 50x50x3mm

- + The best HEX TRAP around
- + Heavy duty with high functionality (different diameter handles)
- + High endurance for many years of professional use



Weight 24 Kg Category F1

168x80x29cm

Super Hex Trap

Triple Grip

46108

\$ 149,00

- > **Tube:** 50x50mm
- Rubber ball heads on the base



Category F1

Open Trap Bar "Void"



43909

\$ 421,80

- > **Tube:** 70x50x3mm
- > **Friction material:** Rubber

- The best sled available
- Top quality, extremely sturdy construction for demanding continuous commercial use for many years to come
- All accessories are included
- Incorporates all types of movement feasible when exercising with a sled
- 3 different push options
- Pulling and lifting exercises
- Central weight support pole

- Lifting and rolling accessory

- Pull accessory

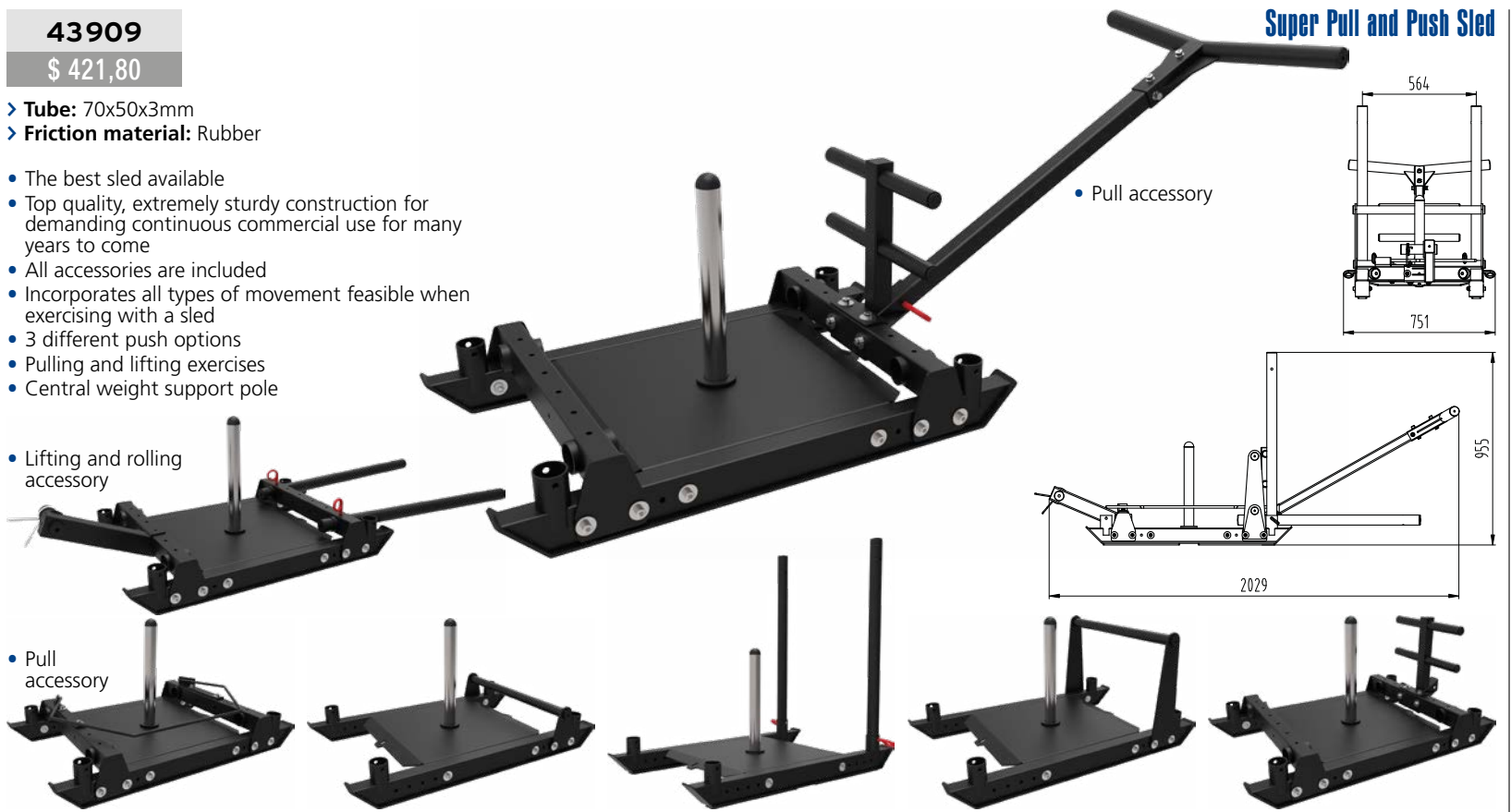

Weight **74Kg** Category **F1**

! The packaging consists of 3 boxes, with a total weight of 80,5kg

• 4 push accessories

202x64x95cm

Super Pull and Push Sled

43911

\$ 169,00

- > **Tube:** 70x50x3mm
- > **Harness:** Included
- > **Friction material:** PE

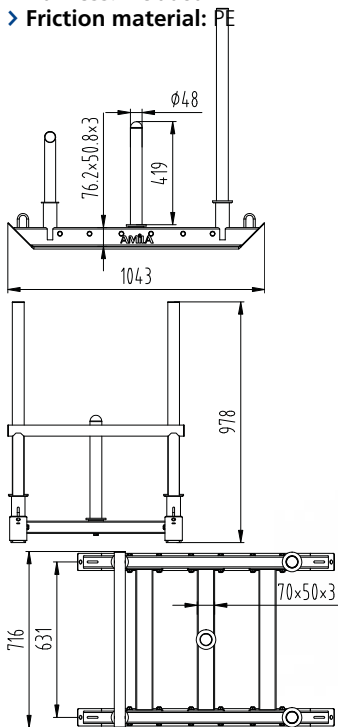

Weight **40,5 Kg** Category **F1**



104x70x98cm

Sled

43915

\$ 382,00

FULL Commercial Grade

GHD Bench

- > **Material:** Steel
- > **Main tube:** 75x50x2.3mm
- > **Seat:** 450x260x221mm, outer material 1,2mm thick, inner material regenerated sponge, medium foam sponge & plank, upholstered in vinyl

- **Easy to adjust** using a single pop-pin

- + **Heavy-duty construction**
- + **Fully customisable**
- + **PU pillow with reinforced cover**



Weight 70Kg | Strength 150Kg | Category F1

202x108x110cm

46109

\$ 235,00

Glute-Ham Developer

- > **Main tube:** 60x60x3.0mm & 50x50x3.0
- > **Seat:** 500x320x160mm, outer material 1,2mm thick, inner material regenerated sponge, medium foam sponge & plank



Weight 38Kg | Strength 150Kg | Category F1

135x80x100cm

95309

\$ 542,00

Crossfit TireFlip 180°

- > **Main tube:** Oval 80x50x2,5mm
- > **Material:** Steel
- > **Xtra weight:** Maximum 2x10Kg on each receptacle (disks not included)



+ Bearings for safe rotation

+ Variable weight with disks



+ Transport wheels



+ Designed with space in the middle for free movement of the legs, eliminating the risk of slipping/tripping

+ Can be bolted to the ground

Weight 125Kg | Tire 44Kg | Category F2

116x162x54cm



SAFE TRAINING

Enjoy training without limits and without fearing getting injured



ADJUSTABLE HEIGHT

Only AMILA GluteMaster can be adjusted to each person's height.



EASY TO STORE

It can be easily stored wherever you want.



COMPETITIVE PRICE



CAN BE COMBINED

Can be combined with other AMILA products.



GREAT DURABILITY

Does not contain movable parts and features an extremely robust frame



AMILA GluteMaster vs Front Squat

The outcome of the National Strength & Conditioning Association (NSCA) research on a 6-week training program of adolescent athletes using a glute machine (similar to the AMILA GluteMaster) versus front squats was published in the scientific journal The Journal of Strength & Conditioning Research.

Before and after the GluteMaster and Front Squat training, the athletes were measured in the following: vertical and horizontal jump, 10 and 20 meters respectively, isometric mid-thigh pull exercise.

What was observed is a significant improvement in running acceleration, horizontal jump and mid-thigh isometric strength.

	HIP THRUST				FRONT SQUAT			
	PRE	POST	D (abs)	D (%)	PRE	POST	D (abs)	D (%)
Body Mass (Kg)	78.32±12.50	79.85±12.7	+1.49±1.38	+1.87	81.16±12.37	81.71±12.55	+0.55±1.69	+0.67
Vertical Jump (cm)	56.31±8.44	58.23±7.82	+1.92±4.48	+3.30	52.27±8.40	56.09±8.22	+3.82±3.43	+6.81
Horizontal Jump (cm)	2.33±0.20	2.38±0.22	+0.06±0.11	+2.33	2.28±0.24	2.32±0.28	+0.04±0.15	+1.69
10m Sprint	1.76±0.07	1.74±0.08	-0.02±0.03	-1.06	1.79±0.08	1.80±0.11	+0.00±0.09	+0.10
20m Sprint	3.13±0.13	3.07±0.14	-0.05±0.05	-1.70	3.16±0.14	3.14±0.16	-0.02±0.11	-0.67
Hip Thrust	115.85±23.53	165±33.07	+49.54±22.49	+29.95	111.36±20.99	134.85±11.20	+23.45±14.77	+17.40
Front Squat	77.57±12.38	83.08±13.77	+5.50±8.53	+6.63	75.00±10.49	84.64±10.03	+9.64±4.80	+1.52
Isometric Mid-Thigh Pull	2254.31±419.03	2815.31±504.21	+361.00±257.86	+9.22	2683.18±258.35	2734.18±213.09	+51.00±210.83	+1.52
Normalized Isometric Mid-Thigh Pull (N/Kg)	32.84±4.39	35.36±4.12	+2.52±3.30	+7.06	33.41±3.37	34.07±4.98	+0.66±2.35	+1.56

43907

\$ 150,80

Glute Master

Adductor and Glut Machine

AMILA®

glutemaster



Lear more about GluteMaster on www.glutemaster.gr or scan the QR



SCAN HERE  to view Glute Master's Video Presentation on our YouTube channel.

SPECIFICATIONS

Dimensions: 147,0x61,0x40,0 cm

NET weight: 27 kg

Frame Tube: 50x50x2 mm

Flooring Material: Rubber

Flooring Thickness: 3 mm

Pad Dimensions: 61x20 cm

Paint: Electrostatic

Category: F1



“Tronic” Hip Thrust

91552

\$ 868,00

FULL Commercial Grade

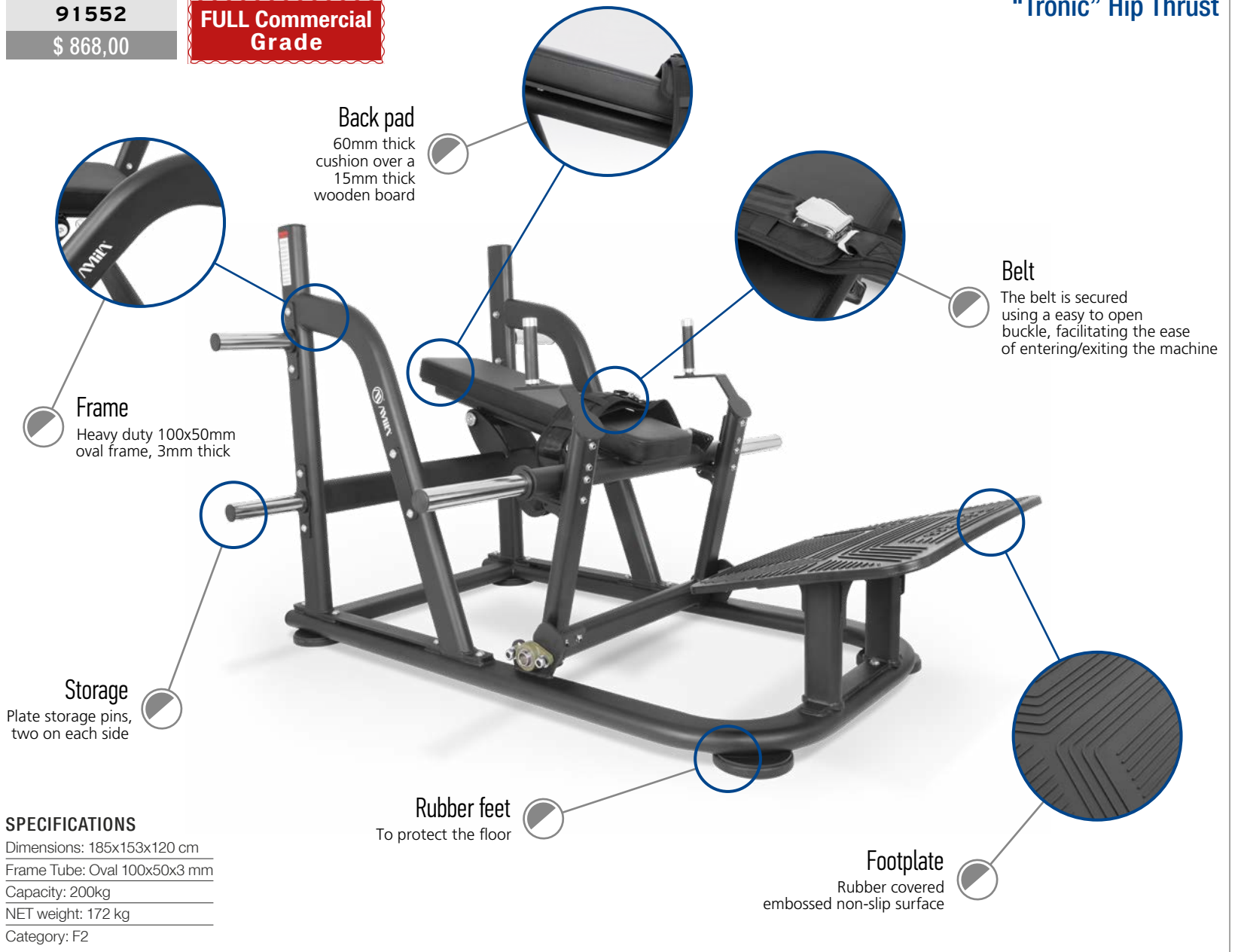

Back pad
60mm thick cushion over a 15mm thick wooden board

Belt
The belt is secured using a easy to open buckle, facilitating the ease of entering/exiting the machine

Frame
Heavy duty 100x50mm oval frame, 3mm thick

Storage
Plate storage pins, two on each side

Rubber feet
To protect the floor

Footplate
Rubber covered embossed non-slip surface

SPECIFICATIONS

Dimensions: 185x153x120 cm
Frame Tube: Oval 100x50x3 mm
Capacity: 200kg
NET weight: 172 kg
Category: F2

44761

\$ 74,90

> **Tube:** Square 45x1,5mm & 38x1,5mm



Sissy Squat

46436

\$ 91,80

Sissy Squat Accessory

To be attached to #46420 cage, p. 44



Category F1

92x58x37~43cm

Power Lifting Bench

91551

\$ 758,00

FULL Commercial Grade

- > **Tube:** 60x60x3 & 75x3mm
- > **Back:** 1220x300x70mm
- > **Seat:** outer material 1,2mm thick, inner material EPE sponge, medium foam sponge & plank

Suitable for Bench Powerlifting events



Weight 140Kg Strength 500Kg Category F2

195x192x110cm

IF2011

\$ 172,00

Semi-Commercial Grade

inimpulse

Adjustable Weight Bench

IF2011

- > **Tubes:** 50,8x76,2x2,5mm, 50,8x2,5mm and 40,0x80,0x2,5mm
- > **Pillow:** Polymer inside, covered by 1,2mm PVC
- > **Seat height:** 502mm
- > **Pillows:** Back 3665x278mm & 503x287mm, seat 400x406mm, all 75mm thick
- > **Seat angles:** 0°, 10°, 20°
- > **Back angles:** -20°, 0°, 20°, 35°, 50°, 65°, 85°



SCAN HERE Promo Video on our YouTube channel



Weight 30Kg Max Weight 350Kg Category F1

127x57x50cm

44752

\$ 230,00

Semi-Commercial Grade

- > **Tube:** 50x75x1.5mm
- > **Back angles:** 0°, 10°, 20°, 30°
- > **Back:** 800x286x50mm
- > **Seat:** 500x340x50mm, outer material 1,2mm thick, inner material EPE sponge, medium foam sponge & plank

+ For personal studios



SCAN HERE to view the Assembly Video on our YouTube channel.



Weight Bench

Weight
41 Kg

Strength
250Kg

Category
F1

109x186x145cm

46106

\$ 207,00

Semi-Commercial Grade

- > **Tube:** Square 50x70x2mm
- > **Back:** 1200x290x60mm, outer material 1,2mm thick, inner material regenerated sponge, medium foam sponge & plank

+ Suitable for small gyms



Weight Bench

Weight
48 Kg

Strength
350Kg

Category
F1

+ Can be bolted to the floor

152x120x121cm

43960

\$ 138,50

- > **Tube:** 50x40x2mm
- > **Back:** 780x265x50mm
- > **Seat:** 340x265x50mm, outer material 1mm thick, inner material medium foam sponge & plank

Weight Bench

FULLY ASSEMBLED



90° incline in vertical position

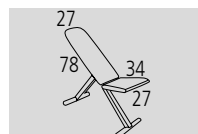

Weight 26 Kg

Strength 350Kg

Category F1

123x33x122cm

44760

\$ 116,50

Semi-Commercial Grade

- > **Tube:** 50x70x1.5mm
- > **Back angles:** -20°, 0°, 20°, 35°, 50°, 60°, 80°
- > **Seat angles:** 0°, 20°, 35°
- > **Back:** 800x286x50mm
- > **Seat:** 286x320x50mm, outer material 1,2mm thick, inner material EPE sponge, medium foam sponge & plank

Sit Up Bench

With wheels



Weight 20 Kg

Strength 250Kg

Category F1

131x59x45cm

44250

\$ 122,00

FOLDING

Combination Bench

- > **Tube:** 50x1.5mm
- > **Back:** 780x310x70mm
- > **Seat:** 310x300x45mm, outer material 0,7mm thick, inner material EPE sponge, medium foam sponge & plank

+ Anatomical shape for proper back support



Weight 31 Kg

Strength 200Kg

Category D7

177x134x131cm

44753

\$ 140,00

Combination Bench

- > **Tube:** 50x1.5mm & 38x1.5mm
- > **Back:** 681x292x50mm
- > **Μαξιλάρι δικεφάλων:** 441x307x50mm
- > **Seat:** 330x254x50mm, outer material 0,7mm thick, inner material EPE sponge, medium foam sponge & plank



Weight 29 Kg

Strength 250Kg

Category D7

140x80x118cm

91402

\$ 118,80

Weight Bench WB510

- > Tube: 50x70x1.5mm
- > Seat wood: 12mm thick

- > Seat pad: 50mm thick
- > Back pad: 50mm thick
- > Max user weight: 130kgs



SCAN HERE 
to view the Assembly Video on our YouTube channel.



- > Max weight for quadriceps' exercises: 45kg
- > Both Ø28 and Ø50 disks can be used

Weight 29kg Strength 250Kg Category D7

186x60x105cm

44756

\$ 109,00

Weight & Sit Up Bench

- > Tube: 50x1,5mm
- > Back: 780x310x45mm
- > Pad: 460x250x45mm
- > Seat: 310x300x45mm, outer material 0,7mm thick, inner material EPE sponge, medium foam sponge & plank



- Easy to adjust back incline



- Adjustable seat incline



- Lockable front, enabling abs exercises

Weight 22,5 kg Strength 250Kg Category D7

185x59x92cm

43968

\$ 125,00

Sit-up Bench

- > Tube size: 50x50x1.5mm
- > Back: 880x260/220x45mm
- > Seat: 370x360-270x45mm



Weight 26 Kg Strength 250Kg Category F1

173x65x43cm

43969

\$ 110,00

Sit-up Bench

- > Tube size: 50x50x1.5mm



Strength 250Kg Category F1

43940

\$ 96,40

- > **Main tube:** 60x30x1.5mm
- > **Back:** 780x270x45mm
- > **Seat:** 330x270x45mm, outer material 0,7mm thick, medium foam sponge & plank

Sit Up Bench



- Leg support for abs exercises



- Adjustable seat incline



- Adjustable back incline



125x50x125cm

Weight 16 Kg Strength 200Kg Category D7

91406

\$ 91,40

- > **Seat pad:** 64mm thick
- > **Back pad:** 64mm thick

Utility Bench AWB550



SCAN HERE  to view the Assembly Video on our YouTube channel.



121x49x113cm

Weight 16 Kg Strength 200Kg Category D7

43966

\$ 80,00

- > **Main tube:** 60x30x1.5mm
- > **Back:** 700x260x50mm
- > **Back angles:** -25°, 0°, 20°, 40°, 55°, 85°
- > **Seat:** 340x260x50mm, outer material 0,7mm thick, inner material regenerated sponge, medium foam sponge & plank

Multi Bench



115x53x48cm

Weight 14 Kg Strength 250Kg Category F1

91403

\$ 72,90

- > **Tube:** 50x50x1.5mm
- > **Seat wood:** 12mm thick
- > **Seat pad:** 50mm thick
- > **Back pad:** 50mm thick

Weight Bench DT30



SCAN HERE  to view the Assembly Video on our YouTube channel.

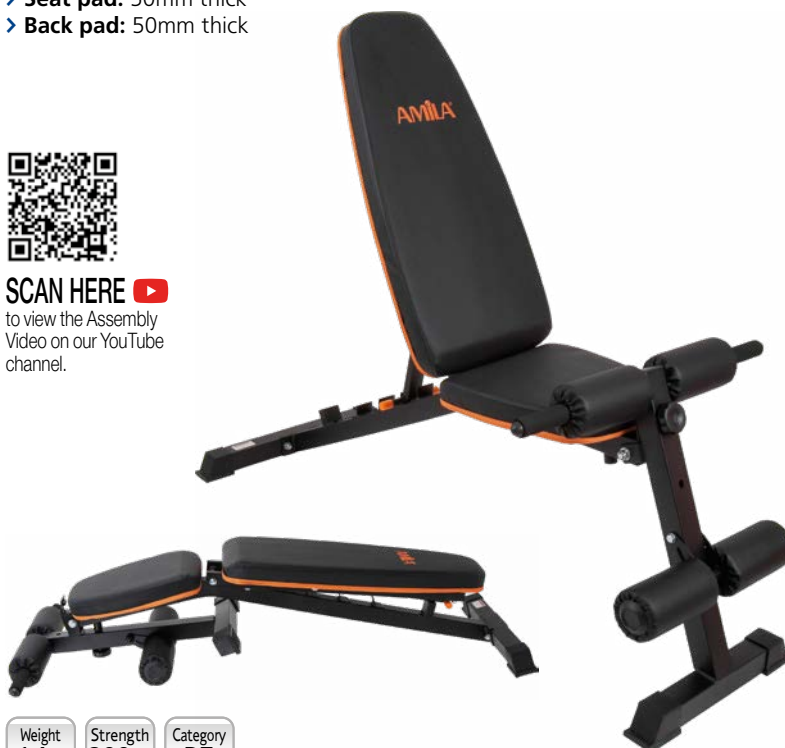

146x67,5x121cm

Weight 14 Kg Strength 200Kg Category D7

44244

\$ 66,20

- > **Main tube:** 70x30x1.8mm
- > **Back:** 750x300x45mm
- > **Back angles:** -10°, 0°, 15°, 35°, 55°, 90°
- > **Seat:** 350x300x45mm, outer material 0,7mm thick, medium foam sponge & plank

Sit Up Bench



Weight 10,5 Kg | Strength 200Kg | Category D7

43906

\$ 86,90

- > **Main tube:** 50x70x2mm

Back Extension



Weight 17 Kg | Strength 120Kg | Category D7

129x66x68cm

43910

\$ 56,50

- > **Main tube:** 50x1.5mm
- > **Back:** 1110x250x55mm, outer material 0,7mm thick, inner material EPE sponge, medium foam sponge & plank

Multi Function Flat Bench



Weight 10 Kg | Strength 200Kg | Category D7

43x111x41cm

44750

\$ 52,80

Sit Up Bench

- > **Main tube:** 38x1.2mm
- > **Back:** 980x300x45mm, outer material 0,7mm thick, inner material EPE sponge, medium foam sponge & plank



Weight
8,5 Kg

Strength
120Kg

Category
D7

123x34x62cm

95205

Primo Skald Squat Stand

Rubber covered to reduce noise

Disc holders, for storage and increased stability

Laser-cut holes, 16,2mm in diameter, to place the accessories on the desired height

Beams made of heavy duty iron, 70,0x50,0 mm, 2mm thick

Can also be used without the horizontal tube in order to be able to change the post spacing

ADD MORE ACCESSORIES TO THE AMILA SQUAT RACK TO INCREASE ITS FUNCTIONALITY. CHOOSE FROM THE FOLLOWING:

- Spotter Arms (code 95223)
- J-hooks (code 95225)
- Landmine (code 95226)
- Dip Handles (code 95227)

SPECS

- Tube: 70,0x50,0x2,0 mm
- Post spacing: 109 cm
- Strength: 250 kg
- J-hooks' height range: 29,9~167,9 cm, 24 positions
- Dimensions: 174,8x93x183,8 cm
- Category: F1

91501

\$ 93,00

Bar Post BR500

44744

\$ 100,40

Bar posts

> Both Ø28 and Ø50 disks can be stored



Fe Steel Weight 26 Kg Category F1

> Max endurance: 200kg



Fe Steel Weight 28,5 Kg Category F1

84~119x93x112~160cm

44745

\$ 99,90

Bar posts

43955

\$ 96,90

Bar Posts

44348

\$ 41,30

Bar Posts

> 9 height positions, 5 width position



Weight 19 Kg Category F1

80~112x70x97~150cm

> Minimum bar height: 126cm

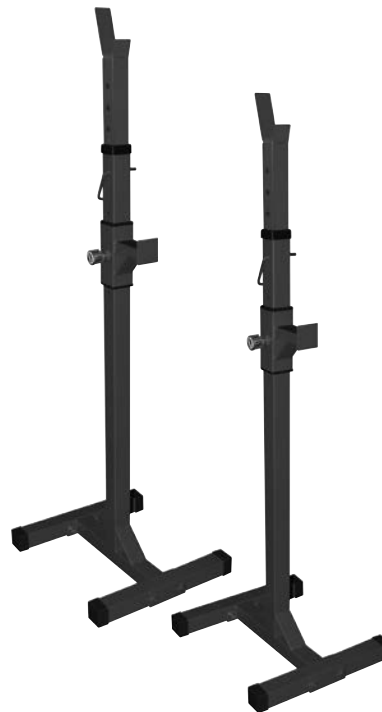

Fe Steel Weight 18 Kg Category D7

48x43x170cm

> Able to support more than 250Kg (the pair)
> Height: 0,80~1,20 µ.



Fe Steel Weight 9,40 Kg Category D7

Ακρίβεια στο Βάρος

Το βάρος ενός μαντεμένου δίσκου μπορεί να κυμαίνεται να κυμαίνεται 7-5% του βάρους του. Εάν είναι πολύ παραπάνω, η ποιότητα δεν είναι καλή.

Φινίρισμα

Το φινίρισμα αποτελείται από 4 στάδια:

1. Σωστή λείανση του δίσκου μόλις βγει από το καλούπι.
2. Βάψιμο με ειδικά αντισκωρικά χρώματα, που μετά το φούρνισμα δημιουργούν, ένα προστατευτικό στρώμα γύρω από τον δίσκο.
3. Το σωστό φούρνισμα του δίσκου, ώστε να δημιουργηθεί ένα προστατευτικό φιλμ, που θα του δίνει ωραία εμφάνιση (εμαγιέ) ενώ ταυτόχρονα το προστατεύει από την οξείδωση (σκουρίασμα).
4. Τέλος περνιέται ένα ειδικό λαδί/βερνίκι που του δίνει λάμψη και προστασία.



Βαφή

Ειδική κατεργασία μετάλλων σε υψηλές θερμοκρασίες και χρήση ποιοτικών χημικών.

Περιεκτικότητα

Περιεκτικότητα Σιδήρου στο Μαντέμι: Όσο πιο λεπτός είναι ο δίσκος, τόσο μεγαλύτερη είναι η περιεκτικότητά του σε σίδηρο. Οι δίσκοι με υψηλή περιεκτικότητα σιδήρου έχουν μεγάλη διάρκεια ζωής και αντέχουν στις καταπονήσεις.

Αναλογία Πρωτογενούς και Ανακυκλώσιμου ελαστικού

Όλα τα λάστιχα έχουν κάποιο ποσοστό ανακυκλώσιμου υλικού. Εάν η αναλογία αυτή ξεπερνά το ανώτερο επιτρεπτό όριο, ενδέχεται το βάρος να αναδύει δυσάρεστες οσμές.



Οι **λαβές** βοηθούν στην ευκολότερη μετακίνηση των δίσκων.

Πάχος του λάστιχου

Εάν η επικάλυψη είναι πολύ λεπτή τότε το πλεονέκτημα του λαστιχένιου βάρους είναι ανύπαρκτο.

Δαχτυλίδι

Διευκολύνει την εναλλαγή των δίσκων.

Περιεκτικότητα

Όσο πιο λεπτός είναι ο δίσκος, τόσο μεγαλύτερη είναι η περιεκτικότητά του σε σίδηρο. **Οι δίσκοι με υψηλή περιεκτικότητα σιδήρου είναι πολύ πιο ποιοτικοί.**

* Τα αλτηράκια βινυλίου μπορούν να καλυφθούν με neoprene. Αυτό προσφέρει μαλακή αίσθηση και μεγαλύτερη προστασία σε περίπτωση πτώσης.

Βάρη

Ένα ποιοτικό Βάρος Εμαγιέ εξαρτάται από:
το Φινίρισμα τη Βαφή και την Περιεκτικότητα

Ένα ποιοτικό Λαστιχένιο Βάρος εξαρτάται από:

Πάχος του λάστιχου, δαχτυλίδι, περιεκτικότητα

* Ο χρήστης μπορεί να δοκιμάσει πρόχειρα την ποιότητα και το πάχος του ελαστικού από την αναπήδηση που παράγεται με την πτώση ενός βάρους 2.5Kg σε μια επιφάνεια.

* Τα πλαστικά αλτηράκια είναι γεμισμένα με ένα μείγμα τσιμέντου και ριניσιμάτων σιδήρου. Το μείγμα αυτό ενδέχεται να μην έχει ισοκατανεμηθεί μέσα στο πλαστικό και έτσι το αλτηράκι μπορεί να έχει κενά και να μην είναι απόλυτα ζυγισμένο

Αλτηράκια Πλαστικά

- Βάρος (δεν υπάρχει ισοκατανομή βάρους)
- Ογκώδη
- Τιμή

Αλτηράκια Βινυλίου

- Βάρος (είναι ζυγισμένα)
- Λειτουργικά (στο σωστό μέγεθος)
- Γυαλιστερή Εμφάνιση
- Τιμή
- Επικινδυνότητα (αν πέσουν ίσως προκαλέσουν ζημιά στο δάπεδο)
- Ευαισθησία (αν δεν είναι ποιοτικά ενδεχομένως να σπάσουν εύκολα)

Δίσκοι Λαστιχένιοι

- Προστασία (δεν προκαλούν ζημιές στο δάπεδο σε περίπτωση πτώσης)
- Αντοχή (αντέχουν σε μεγαλύτερες καταπονήσεις από τα απλά και επιπλέον δεν σκουριάζουν ποτέ)
- Λειτουργικότητα
- Αισθητική (οι λαστιχένιοι δίσκοι πολυτελείας έχουν πολύ πιο ωραία εμφάνιση και μπορούν να μπουν παντού, ακόμη και στο σαλόνι)
- Τιμή

- > **Material:** Cast iron
- > **Cover:** Natural odorless rubber, 70% primary and 30% recycled
- > **Ring:** ABS very robust and nice looking
- > **Suitable** for $\varnothing 28$ mm bars

- Slightly grained surface
- Innovative treatment of a special rubber giving a great look

Rubber Covered Plate



- + Absolutely no smell
- + Great texture
- + Easy to use, since the discs slip easily on the bar due to the ring

- + Thick rubber and flat construction for acceptable floor protection

Category
E1

CODE	PRICE	WEIGHT
44470	\$ 1,10	0,50 Kg
44471	\$ 2,20	1,00 Kg
44472	\$ 5,50	2,50 Kg
44473	\$ 11,00	5,00 Kg
44474	\$ 22,00	10,00 Kg
44475	\$ 44,00	20,00 Kg

- > **Material:** Cast iron
- > **Cover:** Enamelled
- > **Ring:** —
- > **Suitable** for $\varnothing 28$ mm bars

- + The enamelled coating ensures high rust resistance
- + Excellent visual result

Enamelled Plate



Category
E1

CODE	PRICE	WEIGHT
44476	\$ 1,00	0,50 Kg
44469	\$ 2,00	1,00 Kg
44477	\$ 2,50	1,25 Kg
44478	\$ 5,00	2,50 Kg
44479	\$ 10,00	5,00 Kg
44480	\$ 20,00	10,00 Kg
44482	\$ 40,00	20,00 Kg

- > **Material:** Cast iron
- > **Cover:** Natural odorless rubber
- > **Ring:** Plastic
- > **Suitable** for $\varnothing 28$ mm bars

- + Absolutely no smell
- + Acceptable texture
- + Easy to use, since the discs slip easily on the bar due to the ring
- + Thick rubber for acceptable floor protection

Rubber Covered Plate



Category
E1

CODE	PRICE	WEIGHT
44431	\$ 1,18	0,50 Kg
44432	\$ 2,20	1,00 Kg
44433	\$ 5,50	2,50 Kg
44434	\$ 11,00	5,00 Kg
44435	\$ 22,00	10,00 Kg
44437	\$ 48,00	20,00 Kg

- > **Material:** High-quality cast iron
- > **Cover:** High-quality PU
- > **Ring:** Stainless steel
- > For \varnothing 50mm bars

- + Supreme durability, can't be scratched/destroyed
- + No smell whatsoever
- + Sufficient protection for the floor
- + Excellent feel



PU Covered Disc



CODE	PRICE	WEIGHT
84641	\$ 3,85	1,25 Kg
84642	\$ 7,70	2,50 Kg
84643	\$ 15,40	5,00 Kg
84644	\$ 30,80	10,00 Kg
84645	\$ 61,60	20,00 Kg

Category
F1

- > **Material:** Cast iron
- > **Cover:** Natural odorless rubber, 70% primary and 30% recycled
- > **Ring:** Steel
- > **Suitable** for \varnothing 50mm bars

- + Absolutely no smell
- + Natural rubber feel
- + Very robust when compared with standard-quality discs
- + Competitive price



Rubber Covered Disc



CODE	PRICE	WEIGHT
84565	\$ 3,00	1,25 Kg
84566	\$ 6,00	2,50 Kg
84567	\$ 12,00	5,00 Kg
84568	\$ 24,00	10,00 Kg
84564	\$ 25,20	15,00 Kg
84569	\$ 48,00	20,00 Kg

Category
E1

- > **Material:** Cast iron
- > **Cover:** TPU
- > **Ring:** Stainless steel
- > **Suitable** for \varnothing 50mm bars



TPU Covered Disc



CODE	PRICE	WEIGHT
90321	\$ 12,80	5,00 Kg
90323	\$ 39,45	15,00 Kg

Category
E1

Bumper Plates

Με τόσους πολλούς αθλητές να εκδηλώνουν έντονο ενδιαφέρον για την **άρση βαρών** (χάρη στο **CrossFit**) η επιλογή των Bumper Plates, είναι μονόδρομος, ακόμα και αν η προπόνηση είναι το μόνο που θα σας ενδιέφερε.



Θα βρείτε 3 βασικές κατηγορίες ποιότητας στα **Bumper Plates** της **AMILA** με μικρές διαφορές που αφορούν κυρίως την ακρίβεια του βάρους, το οποίο επηρεάζει άμεσα το κόστος παραγωγής τους.

Ποιότητες

• Δίσκοι Προπόνησης

Είναι φτιαγμένοι από 100% πρωτογενές λάστιχο κανονικής καθαρότητας.

Η επιτρεπόμενη διακύμανση του βάρους είναι **+/-1%** (δηλαδή σε βάρος 20Kg η διακύμανση που μπορεί να γίνει αποδεκτή φτάνει μέχρι τα 200gr).

Είναι ιδανικοί για CrossFit όπου η πολύ μεγάλη ακρίβεια στο βάρος δεν είναι το ζητούμενο.

• Χρωματιστοί Δίσκοι

Είναι φτιαγμένοι από 100% πρωτογενές λάστιχο υψηλής καθαρότητας (άριστης ποιότητας).

Η επιτρεπόμενη διακύμανση του βάρους είναι **+/-1%** (δηλαδή σε βάρος 20Kg η διακύμανση που μπορεί να γίνει αποδεκτή φτάνει μέχρι τα 200gr).

Η ποιότητα του ελαστικού αυξάνει την αντοχή κατά 8-10%.

• Αγωνιστικοί Δίσκοι

Είναι φτιαγμένοι από 100% πρωτογενές λάστιχο υψηλής καθαρότητας (άριστης ποιότητας).

Η επιτρεπόμενη διακύμανση του βάρους είναι **+/-5gr**.

Αυτή η ακρίβεια τους καθιστά **κατάλληλους ακόμα και για αγώνες.**

Εξαιτίας του κενού που έχουν μεταξύ του λάστιχου και του ανοξείδωτου μετάλλου των βαρών, διαθέτουν **επιπλέον της ήδη αυξημένης αντοχής** (λόγω της ποιότητας του ελαστικού).

Τι είναι τα Bumper Plates;

Bumper Plates, Δίσκοι Ρίψεων, Δίσκοι Αναπήδησης ή απλά Ολυμπιακοί Δίσκοι είναι οι Ολυμπιακές Πλάκες που **είναι υπενδεδυμένες με τεχνικό τρόπο από χοντρό και σκληρό ειδικό ελαστικό έτσι ώστε μια μπάρα με υψηλό φορτίο να μπορεί να "πέσει" με ασφάλεια, χωρίς κίνδυνο καταστροφής οποιουδήποτε υλικού ή του πατώματος.**

Σκεφτείτε τι θα γινόταν εάν ένας 20κιλος δίσκος έπεφτε στο πάτωμα κατά λάθος, στην προσπάθειά σας να τον μεταφέρετε από και προς την μπάρα και πόσο πιο μεγάλη θα ήταν η ζημιά εάν έπεφτε από υπερυψωμένη θέση κατά τη διάρκεια της άσκησης.

Τα Bumper Plates λοιπόν επιτρέπουν να γίνονται με ασφάλεια όλες οι ασκήσεις που έχουν ρίψεις αλλά και άλλες.

Εμαγιέ Δίσκοι (με επικάλυψη πολουρεθάνης) vs Bumper Plates

Η πιο διαδεδομένη επιλογή για τις ασκήσεις με βάρη είναι οι δίσκοι εμαγιέ που επικαλύπτονται από ένα λεπτό στρώμα πολουρεθάνης (λάστιχου). Πρόκειται για μια επιλογή των γυμναστηρίων (έναντι των απλών εμαγιέ δίσκων που χρησιμοποιούνταν παλαιότερα) επειδή εξασφαλίζουν μεγαλύτερη αντοχή, ευκολία κατά τη χρήση, μικρότερους θορύβους και αγωνιστική εμφάνιση.

Το κόστος αυτών των εμαγιέ δίσκων με επικάλυψη προσεγγίζει περισσότερο τις τιμές αγοράς των bumper plates παρά τις τιμές των εμαγιέ. Όμως, σίγουρα δεν είναι bumper plates. Δεν πρόκειται να πέσουν από ψηλά με ασφάλεια και έτσι καθίστανται άχρηστοι για το CrossFit και την Άρση Βαρών. Εξαιτίας των ανωτέρω και του γεγονότος ότι δεν έχουν ουσιαστική διαφορά κόστους, **δεν υπάρχει κανένας λόγος να σας συστήσουμε αυτό το είδος για τις συγκεκριμένες ασκήσεις.**

Τα Bumper Plates της **AMILA** περνούν το test των 20.000 ρίψεων από ύψος 2 μέτρων.

Σκληρότητα Ελαστικού

Η **Shore Durometer** είναι μια από τις μετρήσεις που μπορούμε να κάνουμε στο ελαστικό. Μια υψηλή μέτρηση υποδηλώνει υψηλή ποιότητα υλικού.

Μεγάλες εταιρίες στον ανταγωνισμό κυμαίνονται μεταξύ 78 και 88 μονάδων μέτρησης. Τα ελαστικά που χρησιμοποιούμε στα προϊόντα **AMILA** ξεπερνούν ακόμα και τις μέγιστες τιμές του ανταγωνισμού καταδεικνύοντας τα **υψηλά standards των επιλογών μας.**



Δαχτυλίδι

Το δαχτυλίδι των δίσκων είναι πάρα πολύ ισχυρό. Έχει ενσωματωθεί με τέτοιο τρόπο έτσι ώστε να μπορεί να αντέχει σε υψηλές πιέσεις που ξεπερνούν τα 2.300Kg.

10 KG	15 KG	20 KG
432± mm	442± mm	452± mm

Χρώματα & Διαστάσεις των Competition Δίσκων

Τα αγωνιστικά Bumper Plates είναι **χρωματισμένα με συγκεκριμένο χρώμα ανά βάρος** ενώ τα Bumper Plates γενικής χρήσης είναι συνήθως μονόχρωμα.

Όλοι οι δίσκοι έχουν την **ίδια διάμετρο (Ø45cm)** σε όλα τα κιλά. **Το μόνο που διαφοροποιείται στις διαστάσεις είναι το πάχος.**

OLYMPIC SIZE

- » For Ø50mm bars
- » Material: 100% Primary rubber and steel



Color Bumper Slim

All the disks have the same 45cm diameter

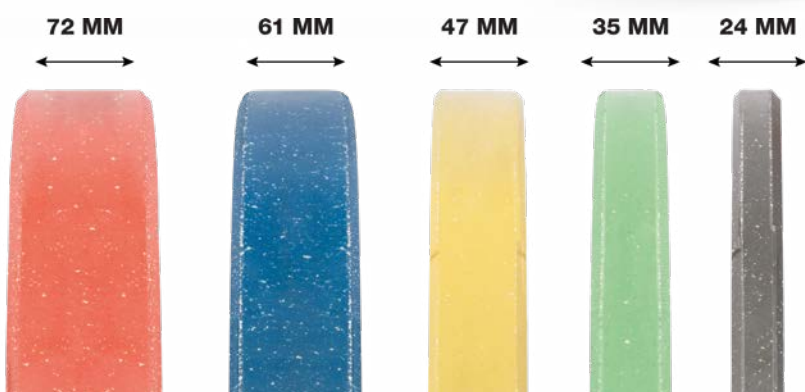

» Items 84846 & 84847 are priced per item, but sold per pair

CODE	PRICE	THICKNESS	WEIGHT	STD PACK	CATEGORY
84846	\$ 17,80	24mm	5,00 Kg	2	E1
84847	\$ 20,20	35mm	10,00 Kg		
84848	\$ 29,00	47mm	15,00 Kg	1	
84849	\$ 38,65	61mm	20,00 Kg		
84850	\$ 48,90	72mm	25,00 Kg		

OLYMPIC SIZE

- » For Ø50mm bars
- » Material: 100% Primary rubber and steel



Splash Bumper Slim

All the disks have the same 45cm diameter

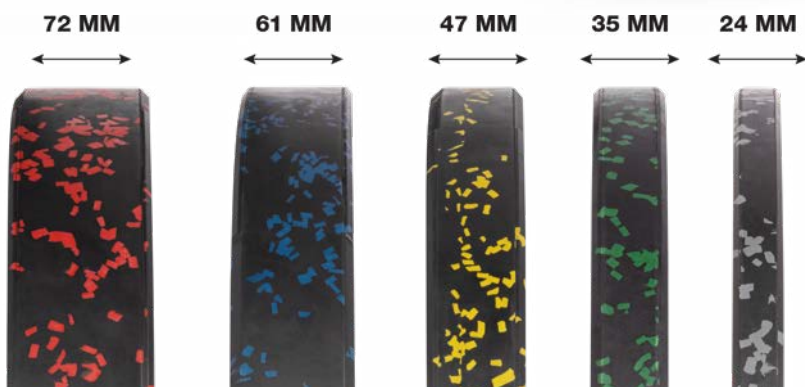

» Items 84836 & 84437 are priced per item, but sold per pair

CODE	PRICE	THICKNESS	WEIGHT	STD PACK	CATEGORY
84836	\$ 17,40	24mm	5,00 Kg	2	E1
84837	\$ 26,80	35mm	10,00 Kg		
84838	\$ 36,20	47mm	15,00 Kg	1	
84839	\$ 45,60	61mm	20,00 Kg		
84840	\$ 55,00	72mm	25,00 Kg		

OLYMPIC SIZE

- » For Ø50mm bars
- » Material: 100% Primary rubber and steel



Black W Bumper Slim

All the disks have the same 45cm diameter

72 MM 61 MM 47 MM 35 MM 24 MM



» Items 84841 & 84842 are priced per item, but sold per pair

CODE	PRICE	THICKNESS	WEIGHT	STD PACK	CATEGORY
84841	\$ 17,80	24 mm	5,00 Kg	2	E1
84842	\$ 20,20	35 mm	10,00 Kg		
84843	\$ 29,00	47 mm	15,00 Kg	1	
84844	\$ 38,65	61 mm	20,00 Kg		
84845	\$ 48,90	72 mm	25,00 Kg		

OLYMPIC SIZE

- » For Ø50mm bars
- » Material: 100% Primary rubber and steel



Black W Bumper Slim

All the disks have the same 45cm diameter

72 MM 61 MM 47 MM 35 MM 24 MM



» Items 84831 & 84832 are priced per item, but sold per pair

CODE	PRICE	THICKNESS	WEIGHT	STD PACK	CATEGORY
84831	\$ 17,80	24 mm	5,00 Kg	2	E1
84832	\$ 20,20	35 mm	10,00 Kg		
84833	\$ 29,00	47 mm	15,00 Kg	1	
84834	\$ 38,65	61 mm	20,00 Kg		
84835	\$ 48,90	72 mm	25,00 Kg		

44372

\$ 25,90

- > **Discs:** 4 x 1.00kg, 2 x 2.00kg
- > **Grip:** 1 pc 2kg, 350x28mm with 2 star collars



Weight 10Kg Category E1

1 x 10kg Chromed Dumbbell Set

44396

\$ 38,60

- > **Discs:** 4 x 1.25kg, 4 x 2.50kg
- > **Grips:** 2 pcs 2,3kg each, 350x30mm with 2 star collars



Weight 20Kg Category E1

2 x 10kg Hammered Dumbbell Set

44375

\$ 6,05

- > **Collar:** Straight
- > **Dimensions:** Ø28mmx35,5cm



Weight 2Kg Category E1

Dumbbell

44155

\$ 3,65



Weight 219gr Category E1

Bar Sponge

Ø10x45cm

90861

\$ 4,95



Category F1

31,5x13,5x5,5cm

Barbell Pad

44376

\$ 6,65

- > **Collar:** Screwed
- > **Dimensions:** Ø28mmx35cm



Weight 2Kg Category E1

Dumbbell

44154

\$ 6,82



Std Pack 15 Category D10

450x78mm

Bar Pillow

For squats

83286

\$ 6,55

- > **Material:** High-density gel
- > **Closure:** Velcro, easy to use



Category F1

Ø7,5x41cm

Barbell Pad

44379

\$ 6,99

- > **Collar:** Screwed
- > **Dimensions:** Ø28mmx35cm



Weight 2Kg Category E1

Dumbbell
Rubber covered grip

44430

\$ 11,40

**OLYMPIC
SIZE**

Olympic Collars

- > Material: Aluminum
- > Diameter: Ø50mm
- > Packing: Polybag



PCS 2 Category E1

44391

\$ 7,00

**OLYMPIC
SIZE**

"Bionic" Collars

- > Material: Nylon
- > Diameter: Ø50mm

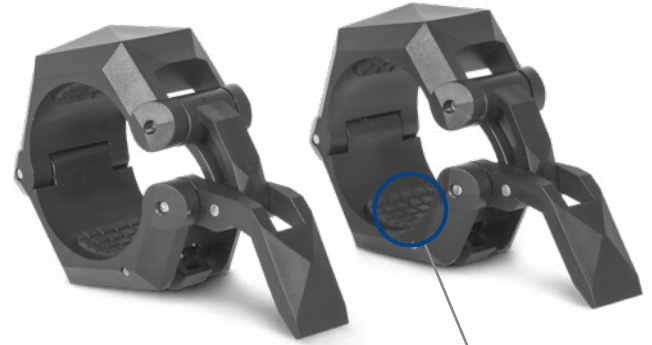

Weight 2x130gr PCS 2 Category E1

Padding TPE rubber

83284

\$ 10,10

Tera Grip

- > Material: Silicone
- > Inner diameter: Ø25mm



PCS 2 Weight 480gr Category E3

Ø5x12cm

44428

\$ 5,48

**OLYMPIC
SIZE**

Olympic Collars

- > Material: Plastic
- > Diameter: Ø50mm
- > Packing: Polybag
- Nylon resin frame and injection molded pressure pads
- Single-action cam lock
- Permanent spring snap-latch, easily released with one hand



44400

\$ 3,00

- > Diameter: Ø28mm

PCS 2 Category E1

44395

\$ 0,90

Collars "Spring"

- > Diameter: Ø28mm



- > Priced per item
- > Sold per pair

PCS 1 Category E1

44392

\$ 0,79

Collars "Ring"

- > Diameter: Ø28mm



- > Priced per item
- > Sold per pair

PCS 1 Weight 51gr Category E1

44390

\$ 1,15

Collars "Star"

- > Diameter: Ø28mm



- > Priced per item
- > Sold per pair

PCS 1 Weight 190gr Category E1

44398

\$ 2,48

OLYMPIC
SIZE

Olympic Collars

"Spring"

> Diameter: Ø50mm



> Priced per item

> Sold per pair

PCS 1 Category E1

90852

\$ 7,05

OLYMPIC
SIZE

Olympic Collars

> Material: Rubber covered Steel

> Diameter: Ø50mm



18,5x9,5x5,5cm

PCS 2 Category E1

44438

\$ 12,90

OLYMPIC
SIZE

Olympic Collars

> Material: Aluminum

> Diameter: Ø50mm

> Heavy duty, each weighting 250gr

> Hermetically locked

> With inner rubber coating to prevent slipping

> Handle made of plastic more durable than ABS

> With magnets for ease of use



PCS 2 Category E1

44397

\$ 90,00

OLYMPIC
SIZE

Collar

> Diameter: Ø50mm

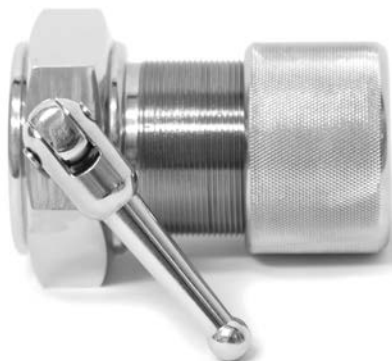

PCS 2 Weight 2,5Kg Std Pack 50 Category E1

διάσταση: 2.18m #80041

Μπάρα Αρσης Βαρών Ολυμπιακού Τυπού "Heavy Duty" 200.000PSI

Αντοχή (Tensile Strength)

Ο αναγραφόμενος αριθμός PSI (Pound per Square Inch) είναι το σημείο θραύσης της μπάρας. Τα 150.000PSI είναι μια καλή τιμή για ασφαλείς μπάρες.

Ωστόσο, τα 200.000PSI της μπάρας AMILA εγγυώνται άρσεις χωρίς προβλήματα!



Μπρούτζινος Τριβέας για εντελώς ανεμπόδιστη περιστροφή

8 Ρουλεμάν Βελόνες

Τα δύο άκρα (sleeves) μιας μπάρας έχουν μεγαλύτερη διάμετρο από τον κεντρικό άξονα και είναι τα σημεία στα οποία βάζουμε τα βάρη.

Τα άκρα περιστρέφονται ανεξάρτητα από τον κεντρικό άξονα-λαβή με τη βοήθεια εδράνων. Ο λόγος για την ανεξάρτητη κίνηση των άκρων είναι απλός. **Η κίνηση των καρπών κατά τη διάρκεια μιας άρσης δημιουργεί περιστροφική κίνηση του άξονα της μπάρας.**

Άκρα (Sleeves)

Η περιστροφή των άκρων πρέπει να είναι **ομαλή**. Αυτό δεν πρέπει να συμβαίνει μόνο όταν η μπάρα είναι καινούρια αλλά καθ' όλη τη διάρκεια ζωής / χρήσης.

Tip *



Οι **PowerBars** έχουν σχεδιαστεί για βαριά **deadlift, squats** και **πιέσεις πάγκου**.

Οι **Ολυμπιακές Μπάρες** έχουν σχεδιαστεί για τις δυο εκρηκτικές κινήσεις της άρσης βαρών, του **αρασέ** και το **επολέ ζετέ (snatch και clean & jerk)**.

Bushing

Bushing είναι τα δαχτυλίδια που κατασκευάζονται με **υλικό χαμηλής τριβής** (συνήθως **μπρούτζο**) τα οποία τοποθετούνται ανάμεσα στον άξονα-λαβή και στο εξωτερικό περιβλήμα του άκρου.

Η τεχνολογία αυτή χρησιμοποιείται σχεδόν σε όλες τις υβριδικές (διπλής χρήσης) μπάρες και στις μπάρες για powerlifting.



Needle Bearings

Η τεχνολογία αυτή συνήθως χρησιμοποιείται σε μπάρες υψηλών επιδόσεων που χρησιμοποιούνται στην **Ολυμπιακή Άρση Βαρών**.

- + Εύκολη περιστροφή
- + Ομαλή κίνηση
- + Αθόρυβη λειτουργία
- Υψηλό κόστος
- Ευαίσθητη τεχνολογία

Βασικά στοιχεία σε μια μπάρα

- Ποιότητα του χάλυβα που χρησιμοποιείται για την κατασκευή της μπάρας
- Διάμετρος της ράβδου
- Ποιότητα και ομαλότητα ρίκνωσης (του κόνδυλου) στην περιοχή λαβής
- Ποιότητα και αριθμός ρουλεμάν που χρησιμοποιούνται στα άκρα (sleeves) στήριξης των βαρών
- Ποιότητα συνδεσμολογίας
- Τήρηση προτύπων σχετικά με το βάρος και το μήκος

Αντοχή (Tensile Strength)

Η αντοχή μιας μπάρας μετράται σε PSI (Pounds/Square Inch, Λίβρες/Τετραγωνική Ίντσα). Ο "ονομαστικός" αριθμός PSI κάθε μπάρας είναι το σημείο θραύσης της μπάρας σύμφωνα με τον κατασκευαστή. Αποφύγετε μπάρες που δεν αναφέρουν τη συγκεκριμένη τιμή στα τεχνικά τους χαρακτηριστικά, αφού κάτι τέτοιο συνήθως σημαίνει ότι η αντοχή τους είναι αρκετά χαμηλή. Γενικά ονομαστική τιμή της τάξης των 150.000PSI είναι ένα καλό ελάχιστο όριο, ενώ με 180.000PSI είναι μια τιμή που εγγυάται άρσεις χωρίς προβλήματα. Γενικά όσο αυξάνεται η αντοχή, τόσο αυξάνεται και η τιμή μιας μπάρας.

Ο **μέσος όρος** των Ολυμπιακών Μπαρών που κατασκευάζονται "πωλούνται" με πιστοποίηση **800 ή 1.000 λιβρών** των 120.000-150.000PSI.

Λαβή Άρση Βαρών

Λαβή Ασκήσεων Πάγκου

Tip *

Στην ουσία **δεν υπάρχει κανενός είδους δοκιμή PSI**.

Αυτό είναι μια φανταστική υπόθεση που δημιουργήθηκε σε μια προσπάθεια να ικανοποιήσει τους αγοραστές με περιορισμένη γνώση και να τους κατευθύνει στην επιλογή τους.

Bars
With straight collar

<p>44350 \$ 13,60</p> <ul style="list-style-type: none"> > Ø28mm x 120cm > b = 18cm > Grip: Ø27,5mm > Max lift: 500lb/227kg <p>Weight 6Kg</p>	<p>44351 \$ 19,40</p> <ul style="list-style-type: none"> > Ø28mm x 140cm > b = 28cm > Grip: Ø28mm > Max lift: 500lb/227kg <p>Weight 7Kg</p>	<p>44352 \$ 22,00</p> <ul style="list-style-type: none"> > Ø28mm x 160cm > b = 31cm > Grip: Ø25mm > Max lift: 500lb/227kg <p>Weight 8Kg</p>	<p>44353 \$ 21,30</p> <ul style="list-style-type: none"> > Ø28mm x 180cm > b = 32.5cm > Grip: Ø28mm > Max lift: 500lb/227kg <p>Weight 9Kg</p>	<p>44354 \$ 22,90</p> <ul style="list-style-type: none"> > Ø28mm x 200cm > b = 38cm > Grip: Ø28mm > Max lift: 500lb/227kg <p>Weight 10Kg</p>	 <p>Category E1</p>
---	---	---	---	--	---

Bars
With screwed collar

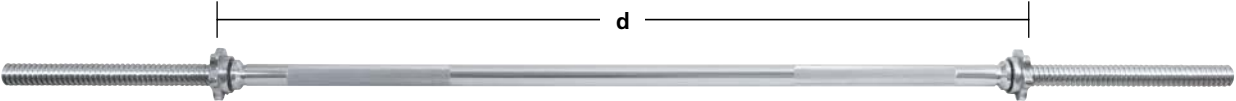
<p>44362 \$ 17,20</p> <ul style="list-style-type: none"> > Ø28mm x 120cm > d ≈ 87,5cm > Max lift: 310lb/140kg <p>Weight 6Kg</p>	<p>44363 \$ 19,70</p> <ul style="list-style-type: none"> > Ø28mm x 152cm > d ≈ 96cm > Max lift: 310lb/140kg <p>Weight 7Kg</p>	<p>44364 \$ 21,20</p> <ul style="list-style-type: none"> > Ø28mm x 160cm > d ≈ 108cm > Max lift: 310lb/140kg <p>Weight 8Kg</p>	<p>44365 \$ 22,50</p> <ul style="list-style-type: none"> > Ø28mm x 180cm > d ≈ 114,5cm > Max lift: 310lb/140kg <p>Weight 9Kg</p>	<p>44366 \$ 23,90</p> <ul style="list-style-type: none"> > Ø28mm x 200cm > d ≈ 127cm > Max lift: 310lb/140kg <p>Weight 10Kg</p>	 <p>Category E1</p>
--	--	---	---	--	---

<p>44356 \$ 15,20</p> <ul style="list-style-type: none"> > Ø28mm x 120cm > b = 17.5cm > Grip: Ø26mm > Max lift: 500lb/227kg <p>Weight 6Kg</p>	<p>44355 \$ 18,39</p> <ul style="list-style-type: none"> > Ø28mm x 140cm > b = 23cm > Grip: Ø27mm > Max lift: 500lb/227kg <p>Weight 7Kg</p>	<p>Bars "W" shaped, straight collar. With straight collar.</p>  <p>Category E1</p>
---	---	---

<p>44360 \$ 15,60</p> <ul style="list-style-type: none"> > Ø28mm x 120cm > Max lift: 310lb/140kg <p>Weight 6Kg</p>	<p>44358 \$ 16,50</p> <ul style="list-style-type: none"> > Ø28mm x 140cm > Max lift: 310lb/140kg <p>Weight 7Kg</p>	<p>Bars "W" shaped, straight collar. With screwed collar.</p>  <p>Category E1</p>
--	--	--

Compression Support

- > **Material:** Neoprene for support and warmth with good compression (5mm in front and 3mm on the back)
- > **Multi-purpose sport**
- > **Protecting** your knees
- > **Provide** support to your knee joint and reduces injury of your knee caused by friction and hitting
- > **Anatomically** designed with ventilation zones for increased comfort



CODE	PRICE	SIZE
83135	\$ 13,90	S
83136	\$ 13,90	M
83137	\$ 13,90	L
83138	\$ 13,90	XL

PCS 2 Category Z5

83287
\$ 9,80

- > **Length:** 62cm
- > **Padding:** Neoprene



Arm Blaster



Category F1

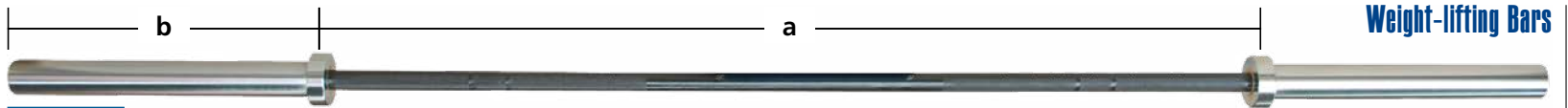

Weight-lifting Bars

OLYMPIC SIZE

> Without collar

Bench press only

Category F1

CODE	PRICE	LENGTH	HEAT TREATMENT	BEARINGS	MATERIAL	COVER HANDLE/ SLEEVES	HANDLE (A)	SLEEVE (B)	MAX STRENGTH	PSI	WEIGHT
44359	\$ 55,40	220cm	✓	—	Q235# Steel	Chrome/Chrome	Ø28.0x1320mm	Ø50x430mm	700lbs	34.000	20kg
44357	\$ 56,70				Ø30.0x1320mm		1000lbs				
44393	\$ 90,90				Ø32.0x1320mm		1200lbs				
80032	\$ 44,20	167cm			Q235# Steel		Ø28.0x1070mm	Ø50x300mm	700lbs	34.000	12kg
80031	\$ 52,50	180cm			—		Ø28.0x1270mm	Ø50x365mm			13kg
80030	\$ 52,00	200cm					15kg				

84534

\$ 43,60

OLYMPIC SIZE

Weight-lifting Bar

"Z" shaped, ideal for training

- > Without collar
- > Ø50mm x 145cm
- > **b** = 17cm



Weight 9 Kg

Category E1

44373

\$ 29,87

OLYMPIC SIZE

Weight-lifting Bar

"W" shaped, ideal for training

- > Without collar
- > Ø50mm x 145cm
- > **a** = 107cm
- > **b** = 19cm
- > **Grip:** Ø25mm
- > **Cover:** Enameled
- > **Max strength:** 287lb/130kg

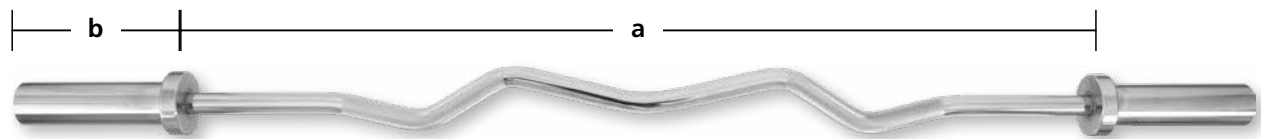

Weight 9,7 Kg

Category E1

94252

\$ 93,70

OLYMPIC SIZE

Swiss Bar

- > **Tube:** 50x25x2,5mm
- > **Length:** 2m
- > **Sleeves:** 4mm thick, hard-chrome covered
- > **Grips:** 30mm diameter



Capacity 300kg

Weight 16Kg

Category F1

84729

\$ 124,90

**OLYMPIC
SIZE**

- > **Material:** Steel alloy
- > **Cover:** Hard chrome
- > **Bearings:** 6 x needle, brass bushing
- > **Handle:** Ø25x1310mm
- > **Sleeve:** Ø50x450
- > **Length:** 221cm
- > **PSI:** 160.000
- > **Max strength:** 1000lb/453,6kg

According to the official specs for
WOMEN'S COMPETITION

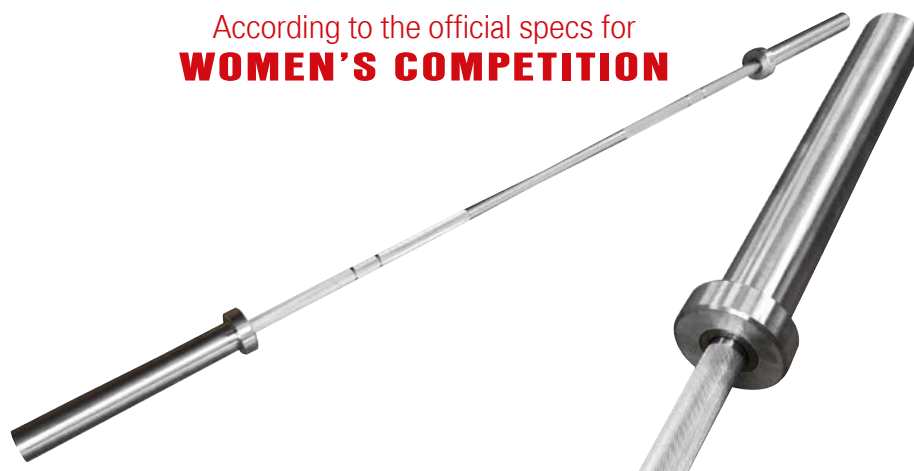

Women's Competition Bar

With grooved sleeves

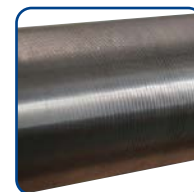

Weight
15 Kg

Category
F1

84730

\$ 69,25

**OLYMPIC
SIZE**

- > **Sleeve:** Aluminum and steel
- > **Cover:** Chrome
- > **Bearings:** 2 x ball, copper bushing
- > **Handle =** Ø28x1030mm
- > **Sleeve =** Ø50x400mm
- > **Length:** 183cm
- > **PSI:** 50.000



Smaller weight, specially designed for
TRAINING



Training Bar

In order to be able to learn the correct body positioning and movements without risking injuries

Weight
7 Kg

Category
F1

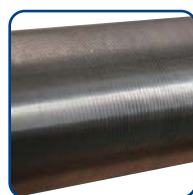

With grooved sleeves

- + They assist in keeping plates in place better when you're not using a collar
- + When using collars, the grooves can significantly help keep some of them from slipping, mostly spring clips or with rubber padding
- They make a zip noise when loading and unloading plates

**OLYMPIC
SIZE**



CrossFit

Category
F1

CODE	PRICE	LENGTH	HEAT TREATMENT	BEARINGS	MATERIAL	COVER HANDLE/ SLEEVES	HANDLE (A)	SLEEVE (B)	MAX STRENGTH	PSI	WEIGHT
80041*	\$ 158,00	221cm	✓	8xNeedle	Steel (alloy)	Hard Chrome	Ø28.0x1321mm	Ø50x450mm	1.500lbs	200.000	20kg

* Exceptional chrome coating, offering superior protection from corrosion

* Bar #80036 without grooves on the sleeves

CrossFit

Category
F1

CODE	PRICE	LENGTH	HEAT TREATMENT	BEARINGS	MATERIAL	COVER HANDLE/ SLEEVES	HANDLE (A)	SLEEVE (B)	MAX STRENGTH	PSI	WEIGHT
80047	\$ 136,50	220cm	✓	—	Steel (alloy)	Hard Chrome	Ø30.0x1310mm	Ø50x445mm	1.500lbs	200.000	20kg
80036*	\$ 133,00			4xNeedle	Spring Steel	Chrome	Ø28.0x1310mm		1.500lbs	170.000	

Stainless-Steel Bars

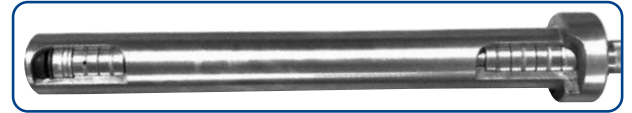

OLYMPIC SIZE

Category F1

CrossFit & Weight-Lifting Training, Stainless steel, will never rust!!!

CODE	PRICE	LENGTH	HEAT TREATMENT	BEARINGS	MATERIAL	COVER HANDLE/ SLEEVES	HANDLE (A)	SLEEVE (B)	MAX STRENGTH	PSI	WEIGHT
80028	\$ 365,00	220cm	—	8 x Βελόνας	Ανοξειδωτο ασάλη	—	Ø29.0x1310mm	Ø50x445mm	1.500lbs	200.000	20kg
80029	\$ 365,00						Ø28.0x1310mm				

Can be dropped from a height (on the condition that a suitable floor is used (#44489) along with the proper CrossFit disks)

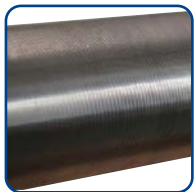

With grooved sleeves

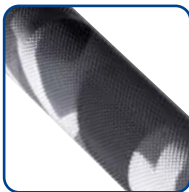

Code #80034 with **camo** print on the handle

OLYMPIC SIZE

Category F1



Polymer-ceramic and QPQ coated Bars

QPQ is a chemical process applied twice, with an in-between polishing stage. It increases the item's properties against wear, corrosion, fatigue strength, while increasing lubricity. More than 10 times better performance than chromed or nickeled finishings.

The **Polymer-Ceramic Composite coating** enhances a number of physical performance properties including abrasion/wear resistance, corrosion resistance, chemical resistance, impact strength, and hardness. It is the ultimate protection that can be applied to surfaces that are corroded by sweat or weather, with many applications, especially in the field of military weapons.

CrossFit, polymer-ceramic coating on the handle, QPQ on the sleeves

CODE	PRICE	LENGTH	HEAT TREATMENT	BEARINGS	MATERIAL	COVER HANDLE/ SLEEVES	HANDLE (A)	SLEEVE (B)	MAX STRENGTH	PSI	WEIGHT
80034	\$ 165,00	220cm	✓	8xNeedle	Steel (alloy)	Ceramic/QPQ	Ø28.0x1310mm	Ø50x445mm	1.500lbs	200.000	20kg
80044	\$ 141,00						Ø29.0x1310mm				
80049	\$ 161,00			Ø30.0x1310mm							
80045	\$ 135,00			4xNeedle			1.000lbs	160.000			

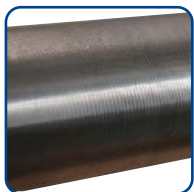

With grooved sleeves



Black Oxide Bars

Black Oxide barbells have the lowest resistance to oxidation and will require more care and maintenance to preserve their appearance than other barbells.

Black Oxide on the handle and the sleeves

OLYMPIC SIZE

Category F1

CODE	PRICE	LENGTH	HEAT TREATMENT	BEARINGS	MATERIAL	COVER HANDLE/ SLEEVES	HANDLE (A)	SLEEVE (B)	MAX STRENGTH	PSI	WEIGHT
80038	\$ 108,00	201cm	✓	4 x Βελόνας	Steel (alloy)	Ø25.0x1310mm	Ø25.0x1310mm	Ø50x350mm	500lbs	130.000	15kg
80039	\$ 118,00	203cm		—				Ø50x360mm	1.000lbs	160.000	
80037	\$ 91,60			500lbs				130.000			

Safe Squat Transpose Bar

Squat bar to perform 6 different exercises in 4 difficulty levels

94251

\$ 149,30

OLYMPIC
SIZE



4 difficulty levels

- > **Sleeves:** Hard chrome covered
- > **Max strength:** 1.500lbs
- > **Colors:** Without

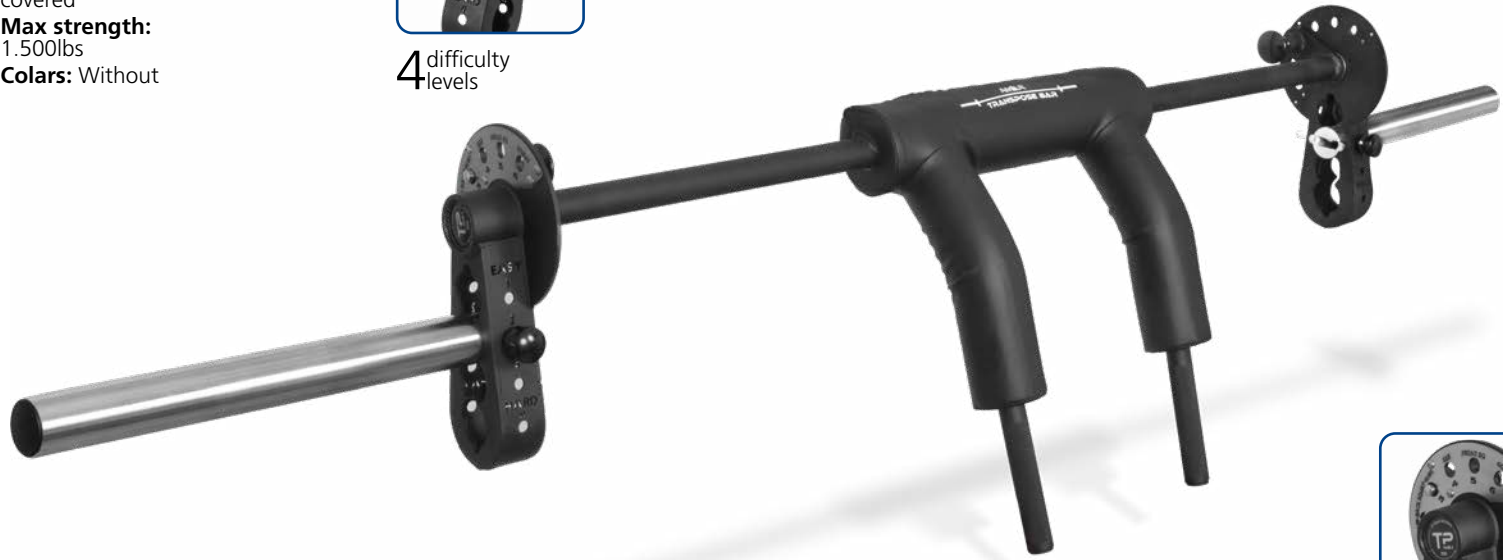

6 different exercises

Weight	Length	Category
25kg	228cm	F1

Safe Squat Bar

94250

\$ 176,20

OLYMPIC
SIZE

- > **Form:** Greatly assists you to perform squats without worrying about whether your posture is correct or not, extremely useful to experienced squatters
- > **Sleeves:** Olympic size, 5° angle to not let the plates slip



- > **Tube:** 50x5mm
- > **Length:** 2209mm
- > **Grips:** 30°

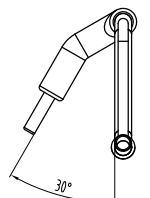
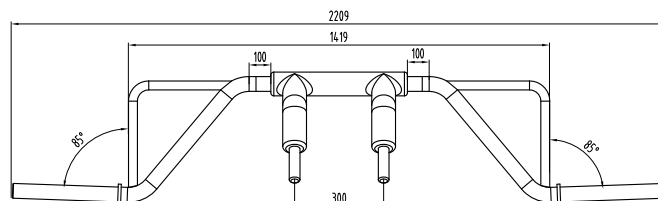

Weight	Category
28kg	F1

95140

\$ 59,90

> **Material:** Outer: Vinyl, Inner: PU Foam

Blast Pad



75x60x20cm

Weight 20kg PCS 2 Category F1

95307

\$ 7,20

EPP Wedge Block SET

Set of 3 pieces



SPECS

Material: EPP

Pieces: 3

1 x height 10,2cm, incline 18°

2 x height 5,1cm, incline 9°

Dimensions: 29,5x15,5cm

Std Pack: 12

Category: E6

- Better range of motion while squatting
- Activates the quadriceps
- Protects and strengthens the knees

Squat Wedges



> **Material:** 3mm thick steel

Capacity 400kg

TMX 2 Category E6

CODE	PRICE	ANGLE	WEIGHT	DIMENSIONS
95304	\$ 49,90	10°	2 x 1,280kg	27x16x5cm
95305	\$ 52,00	20°	2 x 1,750kg	27x16x9cm
95306	\$ 53,90	30°	2 x 1,910kg	27x16x12cm

41990

\$ 110,50

- > **Digits:** 6, 10cm tall
- > **Material:** Mat aluminium
- > **Power:** DC 12V
- > **Remote:** Yes

Crossfit Timer



- > **Functions:** Clock, Intervals, Count-up and 100min, Count-down and 20min, Fight Gone Bad, Tabata, Timer, 10sec count.

> **Memories:** To store custom programs

Category F1

63,8x16x5cm

41913

\$ 34,22

- > **Screen:** LED with adjustable brightness
- > **Functions: 8 =** Rythmn, count down, count up, intervals, Tabata, FGB (Fight Gone Bad), EMOM counter or chronometer
- > **Speaker** for sound alerts on changes and when you reach your goals
- > **Magnets** on the back to place on metal surfaces
- > **Charging cable:** USB Type C (included)
- > **Charging time:** 3 hours

Handy Pocket Gym Timer

With rechargeable battery and magnets on the back



> **Usage time:** 10-20 hours (depending on screen brightness)

SPECS

Weight: 200gr

Std Pack: 50

Category: F1

19x6,3x2cm

95129

\$ 589,00

- > **Material:** 18mm Plywood
- > **Heights:** 7, 15, 30 & 38cm

Jerk Block

Adjustable: Four (4) boxes, allowing for precise adjustment of the height



Weight 180Kg Capacity 200Kg Category F2

90x50cm

44489

\$ 526,50

- > **Dimensions:** 2,5x2m, 3cm thick
- > **Rubber mat:** 8 pcs 3x50x25cm & 8 pcs 3x50x50cm
- > **Wood:** 2x1m

Weight-lifting floor



Category D10

95302

\$ 34,20

Chalk Container

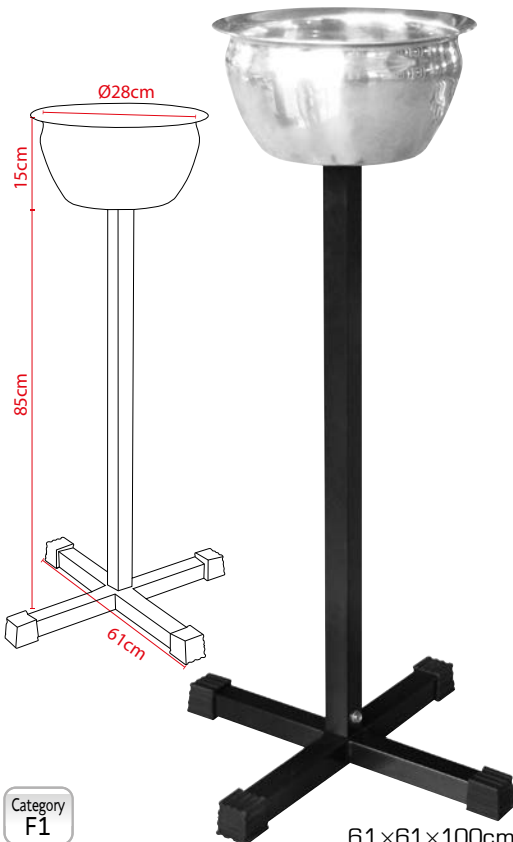

Category F1

61x61x100cm

95301

\$ 1,85

Chalk Powder

In net



Weight 60gr Std Pack 35 Category F1

95303

\$ 9,60

Chalk Powder

In plastic jar



Weight 300gr Std Pack 40 Category F1

Liquid Chalk



Category F1

CODE	PRICE	QUANTITY
95312	\$ 1,70	50ml
95313	\$ 2,65	100ml
95314	\$ 3,65	200ml

43946

\$ 151,20

> Tube:
Oval 80x40x1,8mm

Barbell Rack



Weight 38 Kg Strength 250 Kg Category F1

106x90x126cm

90401

\$ 59,90

Barox Deadlift Bar Jack

Durable & Solid Construction

The sturdy 50x2mm tube construction offers high strength and stability, keeping the bar secured while lifting and changing plates



Ergonomic Design for Easy Lifting

The T-handle, combined with the stable base, aids controlled and smooth lifting of the bar, reducing strain and facilitating the weight change process.

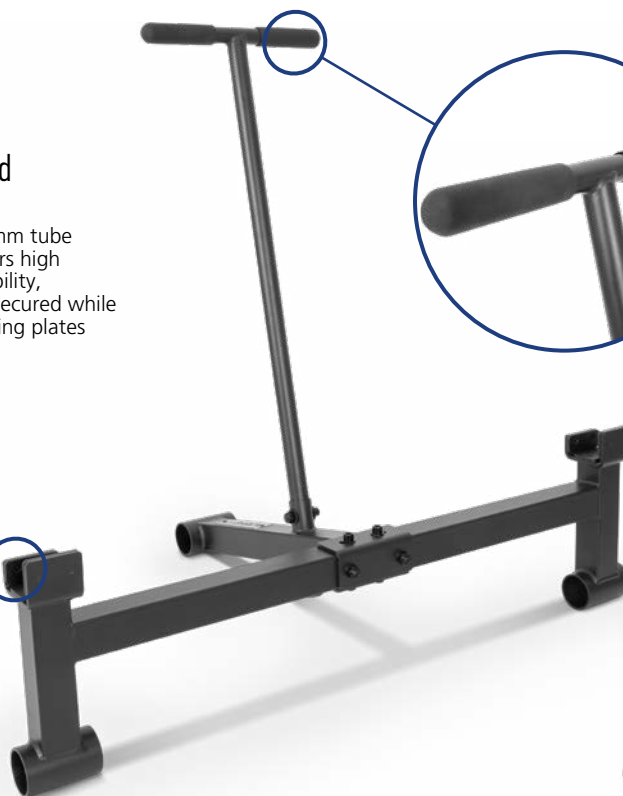

SPECS

Tube: 50x2mm

Weight: 11 kg

Category: F2

> Material: PU

Barbell

PU covered disks



Category
F1

CODE	PRICE	WEIGHT
84711	\$ 67,00	10,00 Kg
84712	\$ 75,70	15,00 Kg
84713	\$ 86,50	20,00 Kg

CODE	PRICE	WEIGHT
84717	\$ 127,50	40,00 Kg
84718	\$ 131,90	45,00 Kg

> Material: 70% recycled rubber
> Shape: Hexagon

Barbell Set

Recycled rubber discs



Category
Z6

CODE	PRICE	WEIGHT
84721	\$ 27,50	10,00 Kg
84722	\$ 41,25	15,00 Kg
84723	\$ 55,00	20,00 Kg
84724	\$ 68,75	25,00 Kg

CODE	PRICE	WEIGHT
84725	\$ 82,50	30,00 Kg
84726	\$ 96,25	35,00 Kg
84727	\$ 110,00	40,00 Kg
84728	\$ 123,75	45,00 Kg

> Material: Recycled rubber
> Shape: Hexagon

Barbell Set

Recycled rubber discs



Category
Z6

CODE	PRICE	WEIGHT
84791	\$ 27,50	10,00 Kg
84792	\$ 41,25	15,00 Kg
84793	\$ 55,00	20,00 Kg
84794	\$ 68,75	25,00 Kg

CODE	PRICE	WEIGHT
84795	\$ 82,50	30,00 Kg
84796	\$ 96,25	35,00 Kg
84797	\$ 110,00	40,00 Kg
84798	\$ 123,75	45,00 Kg

44384

Bar with Handles

\$ 28,10

> Usage: Back



Length 86cm Weight 5.11Kg Std Pack 10 Category E1

44377

Bar with Handles

\$ 22,90

> Usage: Back



Length 85cm Weight 5 Kg Std Pack 5 Category E1

44374

Bar with Handles

\$ 25,60

> Usage: Back



Length 61cm Weight 4.20Kg Std Pack 10 Category E1

44385

Bar

\$ 17,20

> Usage: Lower back



Length 95cm Weight 17.1Kg Std Pack 15 Category E1

44378

Triceps Bar

\$ 12,50

> Usage: Triceps



Length 71cm Weight 3.00Kg Std Pack 10 Category E1

44381

Triceps Bar

\$ 11,00

> Usage: Triceps



Length 51cm Weight 2.22Kg Std Pack 10 Category E1

44361

Triceps Bar

\$ 40,30

> Collar: Straight
> Dimensions: Ø50mm

**OLYMPIC
SIZE**



Length 87cm Weight 9.50Kg Category E1

44367

Triceps Bar

\$ 36,10

> Collar: Screwed
> Dimensions: Ø28mm



Length 85cm Weight 8.57Kg Category E1

44386

Triceps Bar

\$ 13,30

> Usage: Outer triceps



Length 55cm Weight 2.57Kg Std Pack 25 Category E1

44380

\$ 12,35

Triceps Bar

> Usage: Outter triceps



Length 22cm Weight 1.62kg Std Pack 25 Category E1

44389

\$ 5,85

Crossover Grip



Length 15cm Weight 0.67kg Std Pack 30 Category E1

44387

\$ 12,10

Rowing Bar

> Usage: Back



Length 18cm Weight 1.93kg Std Pack 30 Category E1

44382

\$ 13,00

Rowing Bar

Rubber covered grips

> Usage: Back



Weight 2kg Category E1

92701

\$ 75,60

5pcs Multiple-Grip Lat Pull-Down Bars

> Material: 8mm steel

> Specs (see image below, from top to bottom):

- Weight: 4,44kg, W80xH17cm
- Weight: 3,67kg, W61xH17cm
- Weight: 3,51kg, W54xH17cm
- Weight: 2,55kg, W30xH15cm
- Weight: 2,73kg, W31xH19cm

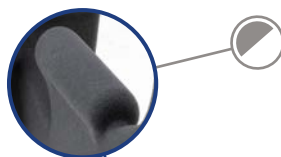

The additional middle grip offers greater flexibility and more exercise positions than classic grips

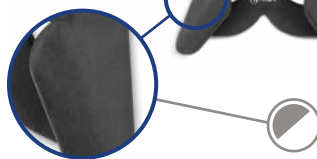

Anti-slip coating

The durable metal construction and ergonomic, non-slip coating ensure a stable and comfortable grip with every repetition. Ideal for pull-ups, tricep extensions and bicep curls, they offer a complete, dynamic workout for the back, shoulders and arms.

Κατηγορία E1

44383

\$ 6,90

Triceps Rope



Weight 0,8kg Category E1

96629

\$ 6,60

Multi-grip Soft-strap Tricep Rope

> Usage: Back, Biceps, Triceps

> Ring: "D" shaped

> Length: 56cm on the short grips, 70cm on the long ones



Inner padding for a more comfortable use

Category E1

96630

\$ 9,10

Multi-grip Soft Nylon Tricep Rope

> Usage: Back, Biceps, Triceps

> Material: Nylon



Carabiner hook on top

Aimed for people not wearing gloves while exercising, thus preferring a softer grip, without sacrificing the strength.

Length 48cm Weight 0,7kg Std Pack 20 Category E1

Original Rubber S Dumbbells

Hexagonal, rubber coated



› Material: Primary rubber, high durability

- + Stainless steel [not cast iron]
- + High durability
- + The Q235 steel shaft is tightened in a unique way
- + Rubber anti-slip covered shaft
- + Will not rust

Category
F1

CODE	PRICE	WEIGHT	CODE	PRICE	WEIGHT
84811	\$ 2,58	1,00 Kg	84820	\$ 21,99	10,00 Kg
84812	\$ 5,16	2,00 Kg	84821	\$ 25,59	12,50 Kg
84813	\$ 7,73	3,00 Kg	84822	\$ 30,70	15,00 Kg
84814	\$ 10,31	4,00 Kg	84823	\$ 35,83	17,50 Kg
84815	\$ 12,89	5,00 Kg	84824	\$ 40,94	20,00 Kg
84816	\$ 15,47	6,00 Kg	84825	\$ 46,06	22,50 Kg
84817	\$ 15,39	7,00 Kg	84826	\$ 51,17	25,00 Kg
84818	\$ 17,59	8,00 Kg	84827	\$ 56,30	27,50 Kg
84819	\$ 19,79	9,00 Kg	84828	\$ 61,41	30,00 Kg

Original Rubber H Dumbbells

Hexagonal, rubber coated



› Material: Primary rubber, high durability

- + Stainless steel [not cast iron]
- + High durability
- + The Q235 steel shaft is tightened in a unique way
- + Rubber anti-slip covered shaft
- + Will not rust

Category
E1

CODE	PRICE	COLOR	WEIGHT
90588	\$ 18,20		7,50 Kg
90589	\$ 19,41		8,00 Kg
90590	\$ 21,83		9,00 Kg
90591	\$ 24,26		10,00 Kg
90594	\$ 39,06		17,50 Kg
90595	\$ 44,64		20,00 Kg
90596	\$ 50,22		22,50 Kg
90597	\$ 60,22		25,00 Kg
90598	\$ 66,25		27,50 Kg
90599	\$ 72,27		30,00 Kg
90600	\$ 73,40		32,50 Kg
90602	\$ 84,69		37,50 Kg

CODE	PRICE	COLOR	WEIGHT
90580	\$ 2,43		1,00 Kg
90581	\$ 4,85		2,00 Kg
90582	\$ 6,10		2,50 Kg
90583	\$ 7,28		3,00 Kg
90587	\$ 13,80		7,00 Kg

Dumbbells

Hexagonal, rubber coated



CODE	PRICE	WEIGHT
84535	\$ 3,80	2,00 Kg
84764	\$ 5,70	3,00 Kg
84536	\$ 7,60	4,00 Kg
84765	\$ 9,50	5,00 Kg
84537	\$ 11,40	6,00 Kg
84766	\$ 13,30	7,00 Kg
84538	\$ 15,20	8,00 Kg
84767	\$ 17,10	9,00 Kg

CODE	PRICE	WEIGHT
84539	\$ 19,00	10,00 Kg
84540	\$ 23,75	12,50 Kg
84541	\$ 28,50	15,00 Kg
84542	\$ 33,25	17,50 Kg
84543	\$ 38,00	20,00 Kg
84544	\$ 42,75	22,50 Kg
84545	\$ 47,50	25,00 Kg
84546	\$ 52,25	27,50 Kg
84547	\$ 57,00	30,00 Kg
84548	\$ 61,75	32,50 Kg
84549	\$ 66,50	35,00 Kg
84598	\$ 71,25	37,50 Kg
84599	\$ 76,00	40,00 Kg
84698	\$ 85,50	45,00 Kg
84699	\$ 95,00	50,00 Kg

- > **Quality:** Medium/Low
- > **Material:** 70% recycled, 30% primary
- > **Smell:** None to slight

Category
F1

PU Covered Dumbbells with Chromed Handle



CODE	PRICE	WEIGHT
94350	\$ 6,10	2,00 Kg
94351	\$ 7,63	2,50 Kg
94352	\$ 12,20	4,00 Kg
94353	\$ 15,25	5,00 Kg

CODE	PRICE	WEIGHT
94354	\$ 18,30	6,00 Kg
94355	\$ 22,88	7,50 Kg
94356	\$ 24,40	8,00 Kg
94357	\$ 30,50	10,00 Kg
94358	\$ 38,13	12,50 Kg
94359	\$ 45,75	15,00 Kg
94360	\$ 53,38	17,50 Kg
94361	\$ 61,00	20,00 Kg
94362	\$ 68,63	22,50 Kg
94363	\$ 76,25	25,00 Kg
94364	\$ 83,88	27,50 Kg
94365	\$ 91,50	30,00 Kg
94366	\$ 106,75	35,00 Kg
94367	\$ 122,00	40,00 Kg
94368	\$ 137,25	45,00 Kg
94369	\$ 152,50	50,00 Kg

- > **Material:** Steel
- > **Cover:** PU
- > **Grip:** Chromed, 15cm long, 3,22cm diameter, knurl with diamond motif

Category
F1

Rubbered Covered Dumbbells with Chromed Grip



- > **Quality:** High, high durability
- > **Material:** 100% primary
- > **Smell:** None

Category
F1

CODE	PRICE	WEIGHT
84520	\$ 6,80	2,50 Kg
84521	\$ 13,50	5,00 Kg
84522	\$ 18,90	7,50 Kg
84523	\$ 25,00	10,00 Kg
84527	\$ 50,00	20,00 Kg
84528	\$ 56,25	22,50 Kg
84531	\$ 75,00	30,00 Kg
84734	\$ 100,00	40,00 Kg

TPU covered Dumbbells



- > **Cover:** TPU

PCS
1

Category
E1

CODE	PRICE	WEIGHT
90621	\$ 7,63	2,50 Kg
90631	\$ 78,96	27,50 Kg

91356

\$ 110,90

Adjustable
Dumbbell



SPECS

Weight: 20 kg

Pieces: 1

Adjustments: 2, 4, 8, 12, 16 and 20 kg

Weight plate diameter: 17.8cm

Material: Cast iron

Handle: Steel, Ø12x10 cm

Dimensions: 18x18x40 cm

Category: E1

91355

\$ 73,50

Stand for
Adjustable
Dumbbell



SPECS

Dimensions: 57x55x73 cm

Weight: 28 kg

Category: E1

Vinyl Dumbbells LOWER QUALITY



CODE	PRICE	COLOR	WEIGHT
90504	\$ 4,42		2,50 Kg
90505	\$ 5,30		3,00 Kg
90506	\$ 7,08		4,00 Kg
90507	\$ 8,84		5,00 Kg

> Cover: Vinyl

PCS 1 Category E1

Vinyl Dumbbells



CODE	PRICE	COLOR	WEIGHT
44491	\$ 2,18		1,00 Kg
44127	\$ 3,25		1,50 Kg
44492	\$ 4,36		2,00 Kg
44493	\$ 6,54		3,00 Kg
44409	\$ 8,70		4,00 Kg
44494	\$ 10,90		5,00 Kg
44120	\$ 13,00		6,00 Kg
44121	\$ 15,10		7,00 Kg
44122	\$ 17,20		8,00 Kg
44123	\$ 19,70		9,00 Kg
44124	\$ 22,00		10,00 Kg

> Cover: Vinyl
> Filling: Cast iron
> Packaging: Plastic bag

PCS 1 Category E1

44490

\$ 133,90

Rack

For 6 dumbbells



Category D7

> Anatomic grip
> Cover: Neoprene

Soft Dumbbells



CODE	PRICE	COLOR	WEIGHT
44448	\$ 5,35		2x1,00 Kg
44449	\$ 10,50		2x2,00 Kg
44450	\$ 14,50		2x3,00 Kg

Price per pair

PCS 2 Category E1

Plastic Dumbbells



CODE	PRICE	COLOR	WEIGHT
44530	\$ 2,45		2x1,00 Kg
44531	\$ 4,20		2x2,00 Kg
44534	\$ 6,20		2x3,00 Kg
44535	\$ 7,55		2x4,00 Kg
44536	\$ 8,05		2x5,00 Kg

PCS 2 Category E1

Kettlebell Cordura



- + Wide grip
- + Very soft
- + They don't damage the floor
- + Competitive price

> Material: Cordura

CODE	PRICE	WEIGHT
84778	\$ 14,50	4,00 Kg
84779	\$ 18,00	6,00 Kg
84880	\$ 20,00	8,00 Kg

> Usage: For Personal Training, especially for women and physical restoration. Not suitable for Crossfit gyms and Bodybuilding Clubs

Kettlebell PVC



- + Wide grip
- + Very soft
- + They don't damage the floor
- + Competitive price

> Material: PVC

CODE	PRICE	WEIGHT
84774	\$ 15,00	4,00 Kg
84775	\$ 17,00	6,00 Kg
84776	\$ 20,70	8,00 Kg
84777	\$ 21,50	10,00 Kg

> Usage: For Personal Training, especially for women and physical restoration. Not suitable for Crossfit gyms and Bodybuilding Clubs

- + Non-slip handles
- + Suitable for susceptible floors
- + For use by women
- + Resistance to moisture, they do not rust



Plasticized Kettlebells

Large color variety

> **Material:** Cement and iron filings
 > **Handle:** Plastic

CODE	PRICE	COLOR	WEIGHT
90481	\$ 2,45		2,00 Kg
90482	\$ 4,90		4,00 Kg
90483	\$ 7,30		6,00 Kg
90484	\$ 9,75		8,00 Kg
90485	\$ 12,20		10,00 Kg
90486	\$ 16,10		12,00 Kg

Category
E1

Vinyl Covered Kettlebell

Big variety of colors
HIGH QUALITY



CODE	PRICE	COLOR	WEIGHT
44504	\$ 9,04		4,00 Kg
44505	\$ 18,00		8,00 Kg
44506	\$ 27,00		12,00 Kg
44507	\$ 36,00		16,00 Kg
44509	\$ 45,00		20,00 Kg

Category
E1

Rubber Covered Kettlebell & Chrome Grip

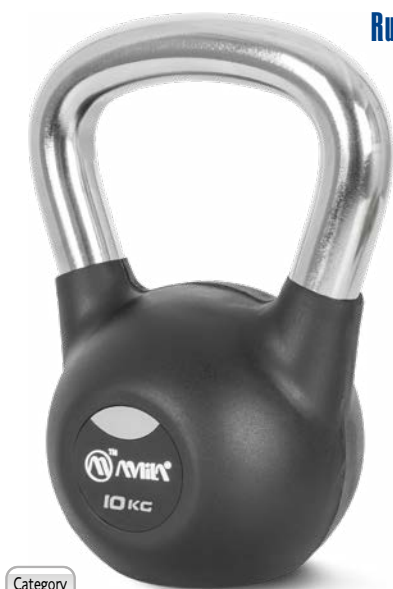

Category E1

> **Coating:** Black natural rubber for absolute protection

CODE	PRICE	WEIGHT
44495	\$ 14,40	4,00 Kg
44571	\$ 15,60	6,00 Kg
44496	\$ 20,80	8,00 Kg
44572	\$ 26,00	10,00 Kg
44497	\$ 31,20	12,00 Kg
44498	\$ 41,60	16,00 Kg
44499	\$ 52,00	20,00 Kg
44573	\$ 56,90	24,00 Kg

Rubber Covered Kettlebell & Chrome Grip



Category E1

> **Coating:** Black natural rubber for absolute protection

CODE	PRICE	WEIGHT
90452	\$ 4,70	2,00 Kg
90453	\$ 8,70	4,00 Kg
90460	\$ 46,00	20,00 Kg



- > **Material:** Nodular cast iron
- > **Cover:** 100% natural rubber
- > **Packaging:** Box

- + Thick and anti-slip grip
- + Full covered by rubber, will not rust

Category E1



Kettlebell Original Rubber

CODE	PRICE	COLOR	WEIGHT
90473	\$ 10,92		4,00 Kg
90474	\$ 16,38		6,00 Kg
90475	\$ 21,83		8,00 Kg
90476	\$ 27,29		10,00 Kg
90477	\$ 32,75		12,00 Kg
90478	\$ 41,24		16,00 Kg
90479	\$ 51,55		20,00 Kg
90480	\$ 58,22		24,00 Kg

Kettlebell

- > **Material:** Cast iron
- > **Handle:** Wide and textured



Category E1

CODE	PRICE	WEIGHT
44680	\$ 9,00	4,00 Kg
44681	\$ 13,25	6,00 Kg
44682	\$ 17,65	8,00 Kg
44683	\$ 22,15	10,00 Kg
44684	\$ 26,50	12,00 Kg
44685	\$ 35,15	16,00 Kg
44686	\$ 43,90	20,00 Kg
44687	\$ 53,00	24,00 Kg
44678	\$ 61,85	28,00 Kg
44679	\$ 70,70	32,00 Kg

Enameled Kettlebell



> **Base:** Special rubber base to protect the floor



Category E1

CODE	PRICE	WEIGHT
44500	\$ 8,50	4,00 Kg
44521	\$ 12,40	6,00 Kg
44501	\$ 16,50	8,00 Kg
44522	\$ 20,65	10,00 Kg
44502	\$ 24,90	12,00 Kg
44503	\$ 33,00	16,00 Kg
44508	\$ 41,00	20,00 Kg
44510	\$ 49,00	24,00 Kg

Η κατασκευή ενός **αγωνιστικού kettlebell** απαιτεί εξειδικευμένη γνώση και εμπειρία που πολύ λίγα εργοστάσια την κατέχουν.

Το **Kettlebell Sport**, είναι ένα άθλημα δύναμης όπου ο νικητής ανακηρύσσεται όχι με βάση το μέγιστο βάρος που μπορεί να σηκώσει για μία επανάληψη, αλλά με βάση το **μέγιστο αριθμό επαναλήψεων** που μπορεί να εκτελέσει ή το συνολικό βάρος (αριθμό επαναλήψεων x βάρος του kettlebell) που μπορεί να σηκώσει με μία από τις αγωνιστικές άρσεις μέσα σε συγκεκριμένο χρονικό διάστημα (συνήθως δέκα λεπτών).

Το κλασικό Kettlebell Sport, γνωστό και ως **Girevoy Sport**, έχει ανακηρυχτεί επισήμως σε εθνικό άθλημα της Ρωσίας το 1974. Σήμερα, οι διάφορες παραλλαγές του Kettlebell Sport (το Girevoy Sport, το άθλημα BOLT που προωθεί κατ' αποκλειστικότητα η International Kettlebell Lifting Federation και οι Μαραθώνιοι ή ημι-μαραθώνιοι αγώνες με kettlebell) διαδίδονται σε όλο τον κόσμο.



Εσωτερικό Υλικό (Γέμιση)

Το αγωνιστικό kettlebell είναι φτιαγμένο από χυτοσίδηρο (μαντέμι). Το εσωτερικό του είναι κενό. Ο όγκος του κενού είναι διαφορετικός για κάθε διαφορετικό βάρος. Ανάλογα με το βάρος του kettlebell χρησιμοποιείται διαφορετικό υλικό.

Τα Αγωνιστικά Kettlebell είναι στο **ίδιο μέγεθος ανεξαρτήτως βάρους**

Δεν υπάρχει άλλο εργαλείο προπόνησης εκτός από τα kettlebells που να **εστιάζει** σε όλες τις φυσικές μεταβλητές που **χρειάζεται ο αθλούμενος** στις πολεμικές τέχνες, ώστε να γίνει ένας ολοκληρωμένος αθλητής.

- Στα **βαριά** kettlebell το κενό είναι γεμάτο με μολύβι.
- Στα **μεσαία** βάρη είναι γεμάτο με σίδηρο.
- Στα **ελαφριά** βάρη είναι γεμάτο με ένα μίγμα παρόμοιο με διογκωμένη πολυουρεθάνη υψηλής πυκνότητας, ώστε το υλικό να είναι συμπαγές και να αντέχει στις κρούσεις.

Tip *

Τα αγωνιστικά kettlebells είναι **κούφια στο εσωτερικό** τους. Γεμίζουν με **έρμα** (μεταλλικά σφαιρίδια διάφορου βάρους και μεγέθους). Ο χώρος περισσεύει καλύπτεται από μονωτικό υλικό που γεμίζει τα κενά και δεν επιτρέπει στο έρμα να κινείται.



Competition Kettlebell

One size, various weights



SCAN HERE

to view a sample video of exercises on our YouTube channel.

CODE	PRICE	COLOR	WEIGHT
84581	\$ 28,65		8,00 Kg
84582	\$ 29,50		12,00 Kg
84583	\$ 39,20		16,00 Kg
84584	\$ 49,00		20,00 Kg
84585	\$ 58,80		24,00 Kg
84586	\$ 68,60		28,00 Kg
84587	\$ 78,40		32,00 Kg
84588	\$ 88,20		36,00 Kg

Category
F1

CLUBBELL



Stand out!

Training with ClubBells is done with many different kinds of swings, which may appear to be a variation of traditional kettlebells. However, even though they belong to the same family, the **long neck**, the **unbalanced weight** and the **multiple movement levels** make ClubBells **unique**, offering **many benefits that can't be obtained as effectively any other way**.

Strength, Concentration and Balance

Through a single swing, the **huge range of motion** and the imbalance caused by the **movement of the center of gravity throughout the whole body**, requires the **use of multi-joint movements** aimed at **strengthening multiple muscle groups**, helping to **improve the stabilising muscles**.

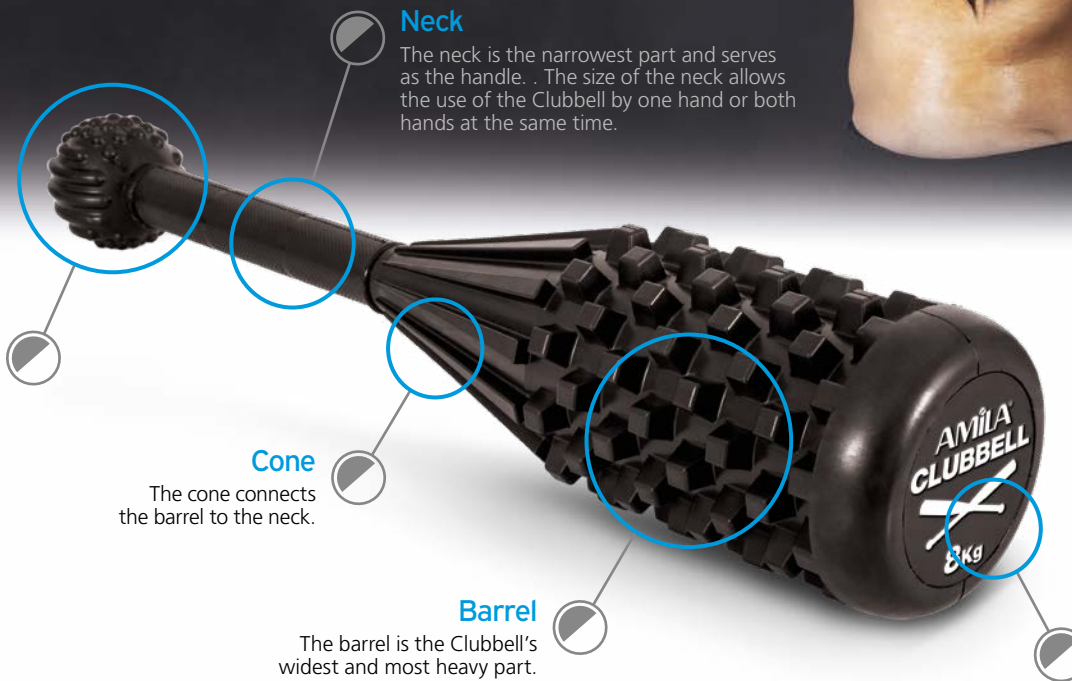

Knob

The knob prevents slippage from your hand.

Neck

The neck is the narrowest part and serves as the handle. The size of the neck allows the use of the Clubbell by one hand or both hands at the same time.

Cone

The cone connects the barrel to the neck.

Barrel

The barrel is the Clubbell's widest and most heavy part.

Muzzle

The muzzle resides at the end of the Clubbell. It is flat, allowing the Clubbell to stand upright.

New-Innovative Exercises

During the past years, exercises using pins, clubs or other longitudinal weights were meant to help improving performance in spears, swords and other weapons. Their use has been minimal in modern times, mainly in Asia (for local sports using swords, rattles etc.) and for sports as baseball and cricket, as a specialized routine.



CODE	PRICE	WEIGHT	DIMENSIONS
91902	\$ 7,58	2,00 Kg	Ø 6 × 40 cm
91903	\$ 15,01	4,00 Kg	Ø 8 × 41,5 cm
91904	\$ 22,29	6,00 Kg	Ø 10 × 51,5 cm
91905	\$ 30,78	8,00 Kg	Ø 10 × 54 cm
91906	\$ 35,78	10,00 Kg	Ø 12 × 55,5 cm
91907	\$ 43,06	12,00 Kg	Ø 12 × 55,5 cm



ARKON Storage Rack

The ARKON Storage Rack by AMILA is the comprehensive storage solution for any training space.

Modular design and fully adaptable to your needs.

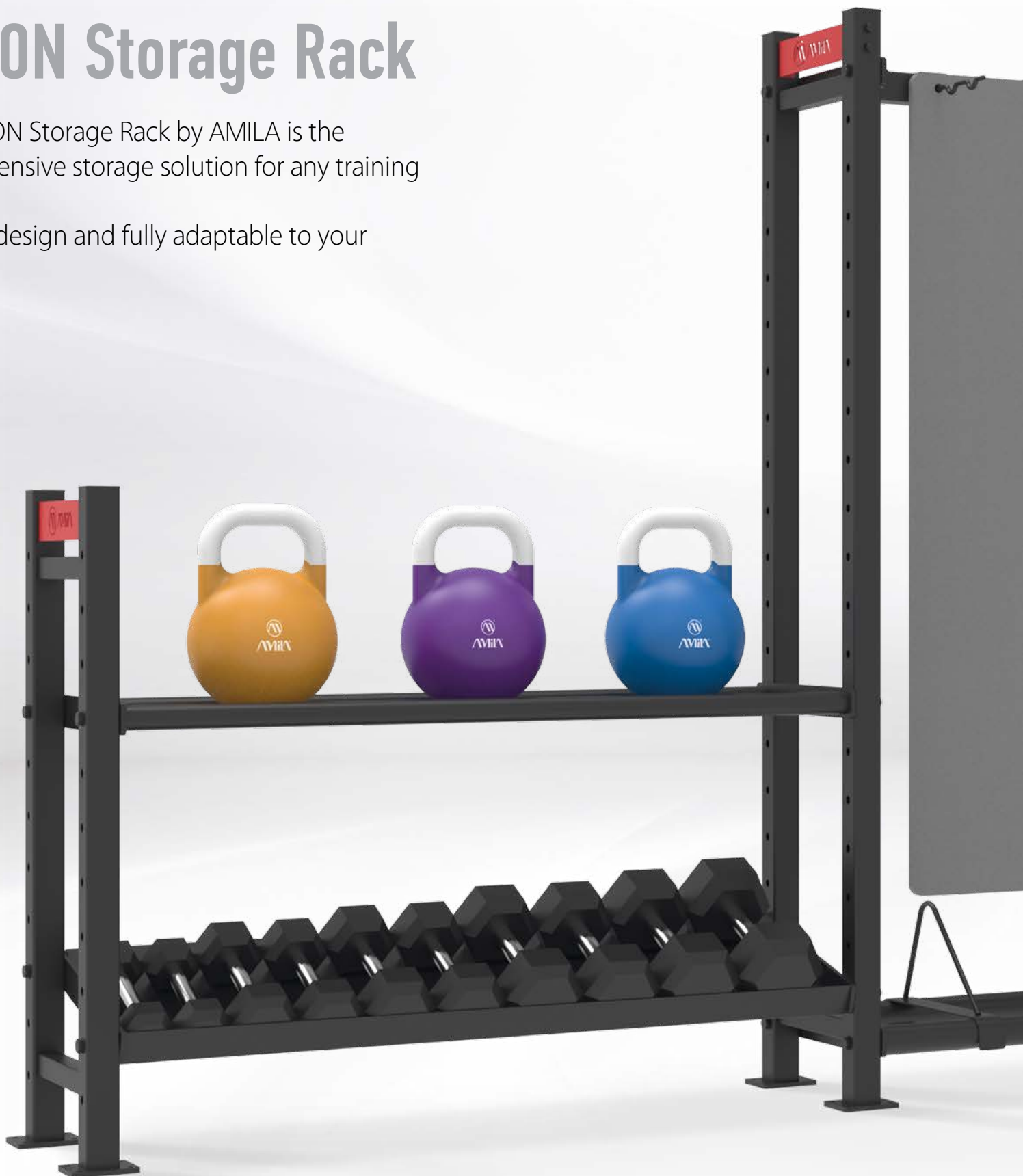



Learn more about the Arkon Storage Rack at www.amila.gr or scan the QR code



ARKON Storage Rack

What is the Arkon Storage Rack

It is a modular storage system, designed for gyms that require durability, functionality, and high aesthetics. With a sturdy metal construction and a maximum load capacity of up to 250 kg per component, every combination will be reliable and commercial grade.

The components (columns, shelves, bases, and accessories) fit together seamlessly to create your own unique setup. From small studios to large gyms, the Arkon Storage Rack ensures ergonomics, space savings, and ultimate safety when using.

Why to choose it

- **Flexibility:** modular design.
- **Durability:** up to 250 kg per component.
- **Quality:** sturdy construction from premium materials.
- **Aesthetics:** minimalist design that enhances your gym.
- **Functionality:** organization that reduces clutter.



Design it the way you want

The Arkon Storage Rack is a modular system that allows you to configure your space as you wish, by combining pillars, shelves, and accessories.

In order to help you, following you may see three sample combos, illustrating ways you may effectively organize

your equipment. These combos are just suggestions — you may freely customize them or create your own unique setup.

What's more, even if your needs change, Arkon allows you to easily reconfigure your rack by adding or removing components as needed.



What is included:

- 95256 PILLAR 1.0 x 2
- 95258 PILLAR 1.8 x 2
- 95260 KETTLEBELL TRAY 1.2 x 1
- 95262 MEDICINE | SLAM TRAY 1.2 x 1
- 95263 PLATE | WALL BALL TRAY 1.2 x 2
- 95264 DUMBBELL TRAY 1.2 x 1
- 95269 ACCESSORY HANGER 1.2 x 1
- 95271 BUMPER PLATE RAILS x 7

Suggested use:

The ideal solution for fully equipped gyms, offering maximum organization and easy access to all types of equipment: plates, dumbbells, kettlebells, slam balls, medicine balls, and accessories.

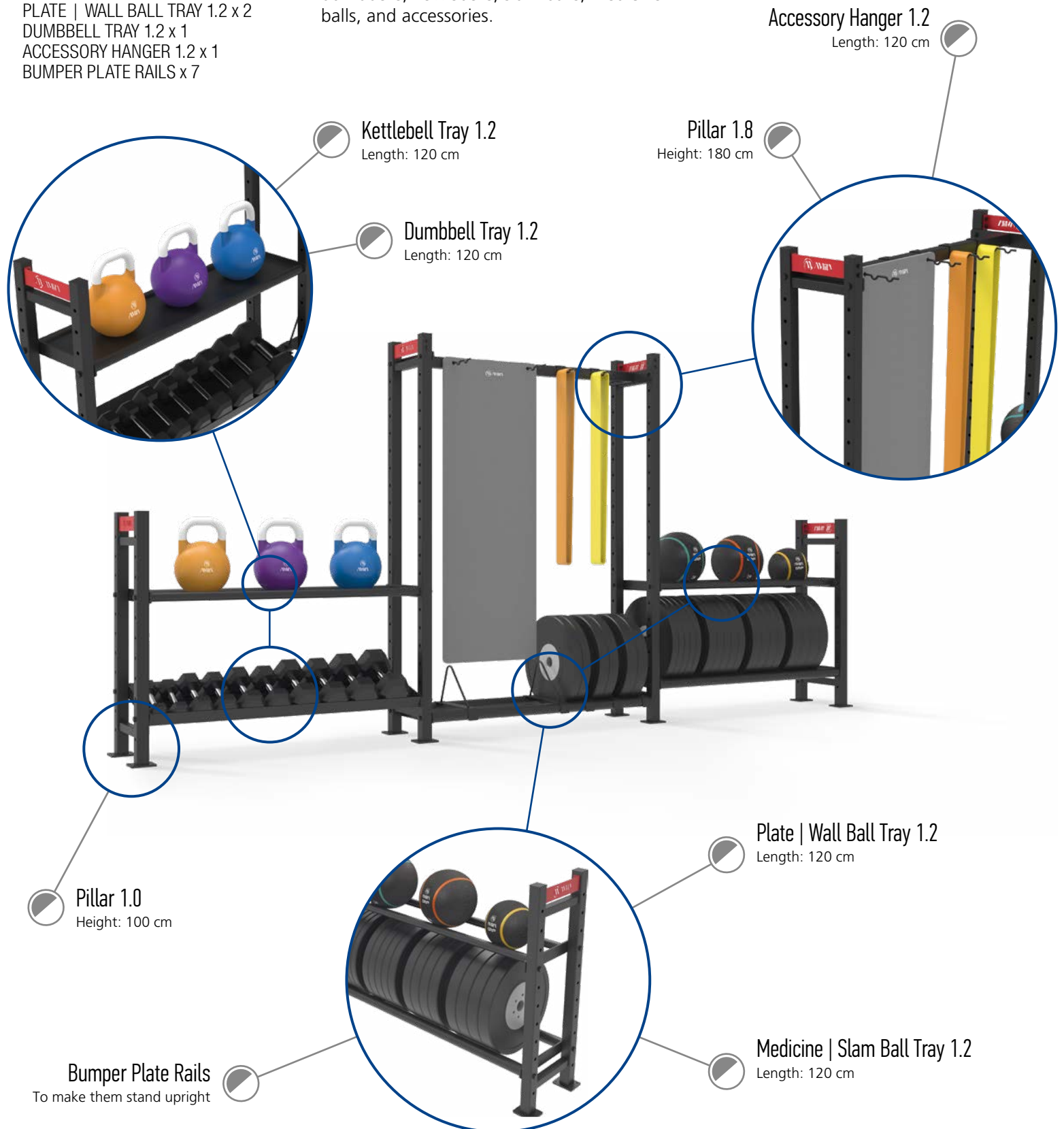

What is included:

- 95258 PILLAR 1.8 x 4
- 95260 KETTLEBELL TRAY 1.2 x 1
- 95263 PLATE | WALL BALL TRAY 1.2 x 1
- 95262 MEDICINE | SLAM TRAY 1.2 x 1
- 95264 DUMBBELL TRAY 1.2 x 2
- 95265 CORNER TRAY x 3
- 95266 STORAGE BASKET 1.2 x 1
- 95268 ACCESSORY HANGER x 1
- 95270 BARBELL STAND x 1
- 95271 BUMPER PLATE RAILS x 5

Suggested use:

Make the most of your available space with a smart corner storage unit.

Ideal for studios and home gyms, it hugs the corner of the room without taking up unnecessary space.

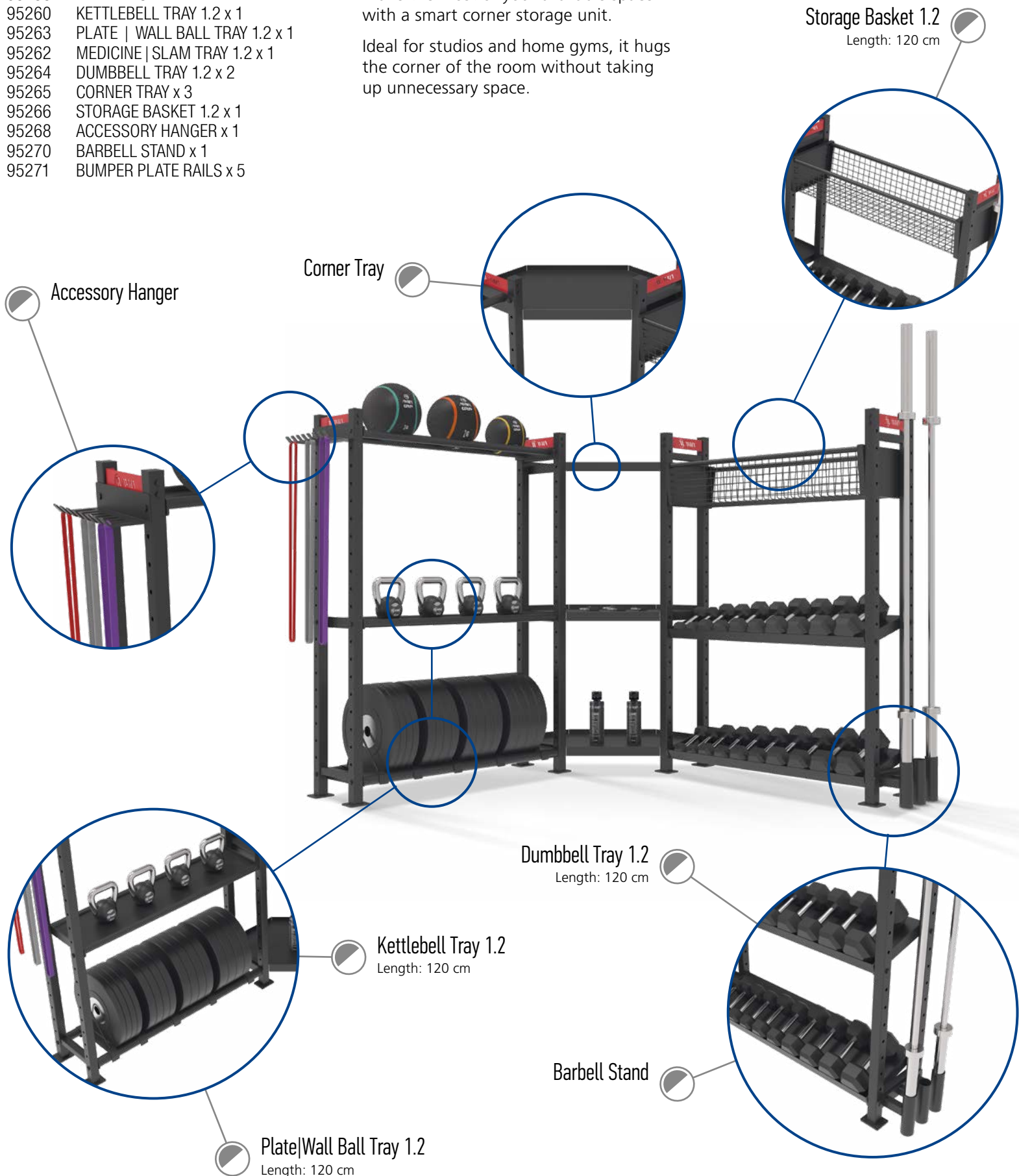

What is included:

- 95256 PILLAR 1.0 x 1
- 95258 PILLAR 1.8 x 2
- 95262 MEDICINE | SLAM TRAY 1.2 x 1
- 95263 PLATE | WALL BALL TRAY 1.2 x 4
- 95272 WHEELS x 3
- 95271 BUMPER PLATE RAILS x 6

Suggested use:

A more flexible and portable solution, for spaces requiring mobility and adaptability.

Compact and mobile setup, easily transportable without sacrificing stability or commercial appearance.





CODE	PRICE	DIMENSIONS (cm)	MATERIAL THICKNESS (mm)	CAPACITY (kg)	NET WEIGHT (kg)	CATEGORY
95256	\$ 38	38,2x10,1x100,0	1,5		8,5	F2
95257	\$ 56	38,2x10,1x150,0			11,6	
95258	\$ 61	38,2x10,1x180,0			14,0	

Kettlebell Tray 1.0 | 1.2



CODE	PRICE	DIMENSIONS (cm)	MATERIAL THICKNESS (mm)	CAPACITY (kg)	NET WEIGHT (kg)	CATEGORY
95259	\$ 46	101,4x35,0x5,0	3,0	250,0	15,6	F2
95260	\$ 52	121,4x35,0x5,0			18,0	

95264
\$ 87

Dumbbell Tray 1.2



SPECIFICATIONS

Dimensions: 121,4x36,0x5,0 cm
 Thickness: 2,0 mm
 Capacity: 250,0 kg
 NET weight: 18,0 kg
 Category: F2

95265
\$ 54

Corner Tray



SPECIFICATIONS

Dimensions: 100,0x49,5x7,7 cm
 Thickness: 3,0 mm
 Capacity: 250,0 kg
 NET weight: 2,5 kg
 Category: F2



CODE	PRICE	DIMENSIONS (cm)	MATERIAL THICKNESS (mm)	CAPACITY (kg)	NET WEIGHT (kg)	CATEGORY
95261	\$ 37	101,4x35,5x5,0	3,0	250,0	8,0	F2
95262	\$ 42	121,4x35,5x5,0			9,5	

95263

\$ 42

Plate | Wall Ball Tray 1.2

95266

\$ 137

Storage Basket 1.2

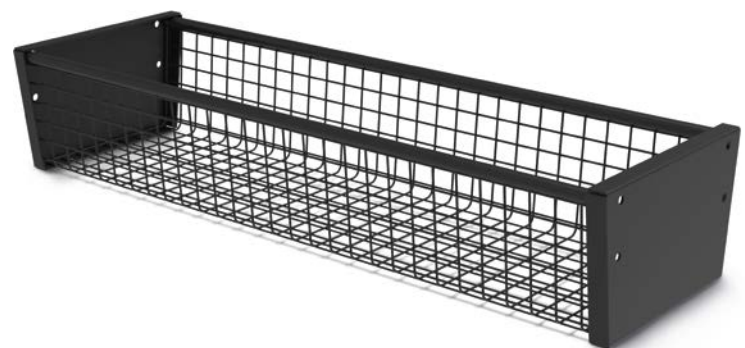

SPECIFICATIONS

Dimensions: 121,4x35,0x5,0 cm
 Thickness: 3,0 mm
 Capacity: 250,0 kg
 NET weight: 11,5 kg
 Category: F2

SPECIFICATIONS

Dimensions: 121,4x38,4x23,2 cm
 Thickness: 4,0 mm
 Capacity: 250,0 kg
 NET weight: 12,0 kg
 Category: F2

95269

\$ 50

Accessory Hanger 1.2

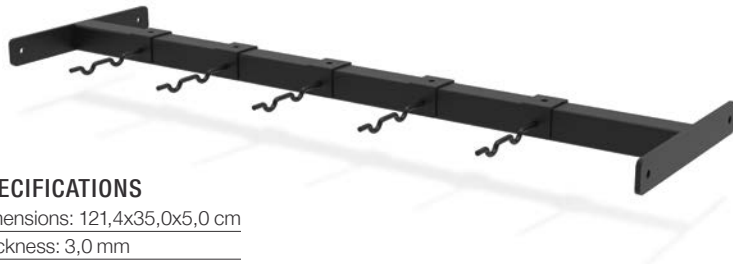

SPECIFICATIONS

Dimensions: 121,4x35,0x5,0 cm
 Thickness: 3,0 mm
 Capacity: 250,0 kg
 NET weight: 8,0 kg
 Category: F2

95268

\$ 15

Accessory Hanger



SPECIFICATIONS

Dimensions: 35,0x15,0x8,0 cm
 Thickness: 4,0 mm
 Capacity:
 NET weight: 2,5 kg
 Category: F2

95267

\$ 13

Plate Storage



SPECIFICATIONS

Dimensions: 30,3x5,0x12,0 cm
 Thickness: 2,0 mm
 Capacity:
 NET weight: 1,5 kg
 Category: F2

95270

\$ 19

Barbell Stand



SPECIFICATIONS

Dimensions: 35,0x15,8x19,8 cm
 Thickness: 2,0 mm
 Capacity:
 NET weight: 5,0 kg
 Category: F2

95271

\$ 5

Bumper Plate Rails



SPECIFICATIONS

Dimensions: 5,0x35,6x23,5 cm
 Thickness: 3,0 mm
 Capacity:
 NET weight: 1,5 kg
 Category: F2

95272

\$ 9

Wheels



SPECIFICATIONS

Dimensions: 10,1x8,2x8,8 cm
 Thickness:
 Capacity: 500,0 kg
 NET weight: *** kg
 Category: F2



CODE



PRICE



NAME

























DIMENSIONS (cm)



PAGE

ARKON Storage Rack

	95256	\$ 38	Pillar 1.0	38,2 × 10,1 × 100,0	132
	95257	\$ 56	Pillar 1.5	38,2 × 10,1 × 150,0	132
	95258	\$ 61	Pillar 1.8	38,2 × 10,1 × 180,0	132
	95259	\$ 46	Kettlebell Tray 1.0	101,4 × 35,0 × 5,0	132
	95260	\$ 52	Kettlebell Tray 1.2	121,4 × 35,0 × 5,0	132
	95261	\$ 37	Medicine Slam Ball Tray 1.0	101,4 × 35,5 × 5,0	132
	95262	\$ 42	Medicine Slam Ball Tray 1.2	121,4 × 35,5 × 5,0	132
	95263	\$ 42	Plate Wall Ball Tray 1.2	121,4 × 35,0 × 5,0	132
	95264	\$ 87	Dumbbell Tray 1.2	121,4 × 36,0 × 5,0	133
	95265	\$ 54	Corner Tray	100,0 × 49,5 × 7,7	133
	95266	\$ 137	Storage Basket 1.2	121,4 × 38,4 × 23,2	134

 CODE	 PRICE	 NAME	 DIMENSIONS (cm)	 PAGE
	95267	\$ 13	Plate Storage	30,3 × 5,0 × 12,0 135
	95268	\$ 15	Accessory Hanger	35,0 × 15,0 × 8,0 135
	95269	\$ 50	Accessory Hanger 1.2	121,4 × 35,0 × 5,0 135
	95270	\$ 19	Barbell Stand	35,0 × 15,8 × 19,8 135
	95271	\$ 5	Bumper Plate Rails	5,0 × 35,6 × 23,5 135
	95272	\$ 9	Wheels	10,1 × 8,2 × 8,8 135

MS704001

Storage Rack Frame MS704001

- > To be used as the connecting attachment of the storage platform, both sides can be connected with the storage rack
- > **ONLY** to be used with MS704002-MS7040005 storage shelves below

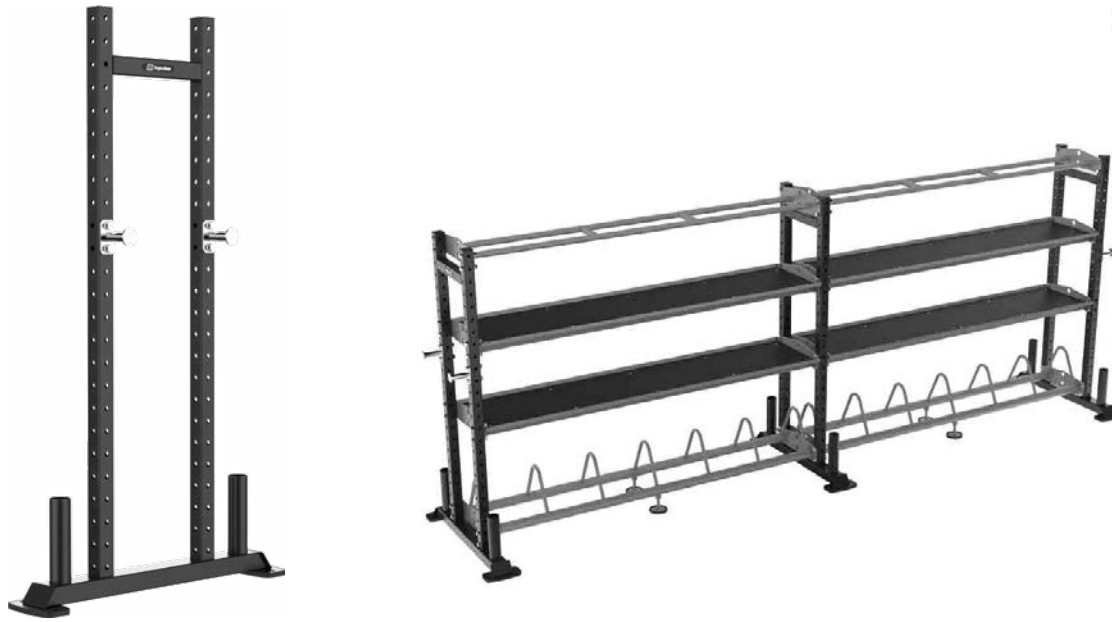

Weight
20.2 kg

Category
F2

156×87×21cm

MS704004

Ball Storage MS704004

- > Can meet all kinds of ball props such as rhythm ball, wall ball, medicine ball and other storage needs.
- > **ONLY** to be used with MS704001 frame in order to create a storage rack

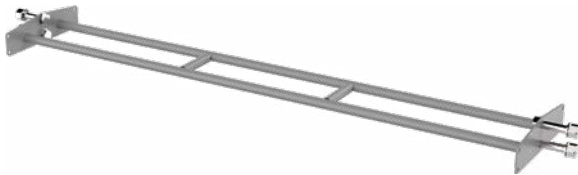

Weight
14.9 kg

Category
F2

39×202×11cm

MS704005

Dumbbell Storage MS704005

- > It can meet the storage needs of dumbbells of various specifications.
- > **ONLY** to be used with MS704001 frame in order to create a storage rack



Weight
25 kg

Category
F2

39×202×11cm

MS704002

Bumper Plate Storage MS704002

- > It can meet the storage needs of weight plate of various specifications.
- > **ONLY** to be used with MS704001 frame in order to create a storage rack



Weight
20 kg

Category
F2

39×202×29cm

MS704003

Kettlebell Storage MS704003

- > It can meet the storage needs of various props and, at the same time, used as a storage platform for other tools.
- > **ONLY** to be used with MS704001 frame in order to create a storage rack



Weight
36.8 kg

Category
F2

44×202×11cm

43959

\$ 78,20

- > **Tube:** Oval 80x40x1,8mm
- > Can be used with 45cm diameter plates

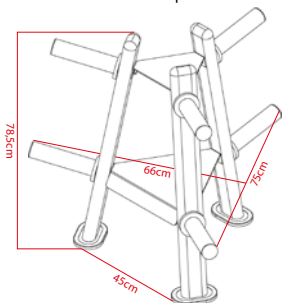

> **Length:** 25cm



Plate Rack

Weight 14 Kg Capacity 300 Kg Category D7

43936

\$ 91,00

- > **Tube:** 60x60x2mm
- > **Wheels:** For easy transport



Plate Rack

Weight 20Kg Capacity 350Kg Category E1

75x60x120cm

43949

\$ 52,90

- > **Tube:** Oval 70x30x1,8mm



Plate Rack

Weight 11 Kg Capacity 250 Kg Category D7

52x70x88cm

43935

\$ 90,20

- > **Tube:** 45x45x2mm
- > **Capacity:**
1,25kg x 4 pcs, 2,50kg x 2 pcs
5,00kg x 2 pcs, 10,00kg x 2 pcs
15,00kg x 2 pcs, 20,00kg x 2 pcs
25,00kg x 2 pcs

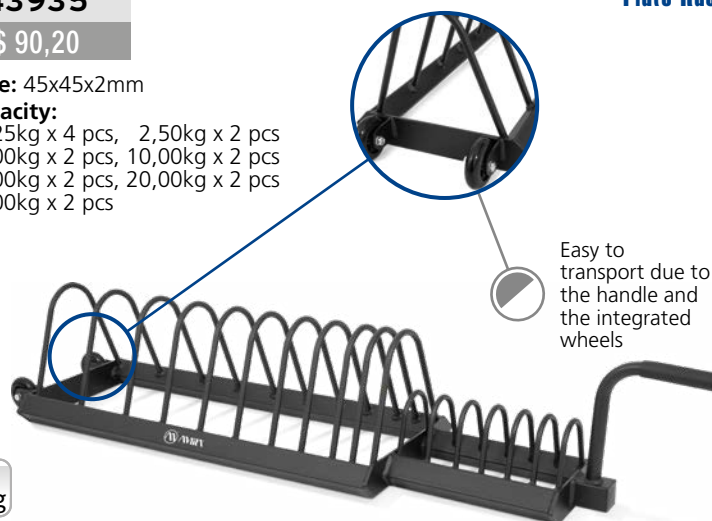

Easy to transport due to the handle and the integrated wheels

Plate Rack

Weight 16Kg

Category E1

146x34x28cm

Hald Pump Set Rack

91352

\$ 138,60

Collars
They can store collars on the vertical receptacles on the back

Tubes

80x40x1.8mm & 60x30x1.5mm

Plates

For plates with a Ø25 diameter hole and larger

Bars

Can accommodate up to 12 bars

SPECS

Dimensions: 113x56x85 cm

Std Pack: 1

Category: F1

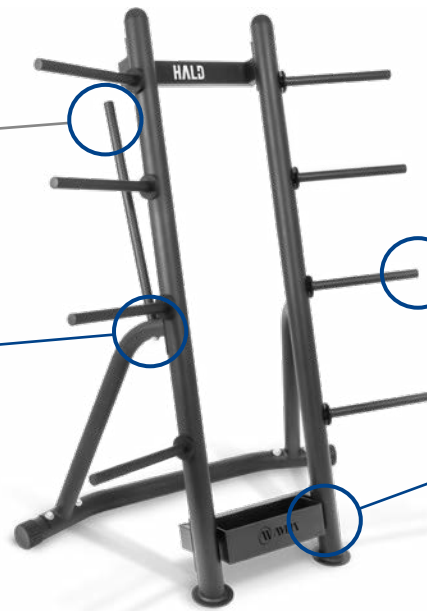

91354

\$ 81,50

OLYMPIC SIZE

Barbell Floor Rack

> **Main tube:**
60x60x2mm



FULL Commercial Grade

45x45x23cm

91353

\$ 61,60

OLYMPIC SIZE

Barbell Floor Rack

> **Main tube:**
80x40x1.8mm & 50x50x2mm



70x63x26cm

43950

\$ 42,10

For Personal Training

> **Diameter:** 28mm
> **Max weight:** 100kg

Light colored



Plate Rack



72x38x91cm

43953

\$ 52,90

OLYMPIC SIZE

> **Diameter:** 50mm
> **Max weight:** 150kg

Dark colored



43934

\$ 53,90

OLYMPIC SIZE

Barbell Floor Rack

> **Tube:**
50x50x2mm

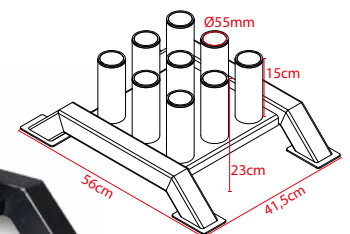

Weight 10Kg

Category F1

Weight 8 Kg

Category D7

43946

\$ 151,20

Barbell Rack

> Tube:
Oval 80x40x1,8mm



Weight 38 Kg Strength 250 Kg Category F1

106x90x126cm

43952

\$ 169,00

Barbell Rack EX

> Max weight:
200kg

Semi-Commercial Grade



Weight 38 Kg Category F1

85x85x148.5cm

43933

\$ 87,80

Barbell Wall Rack

- Just bolt to the wall at your desired width and height
- > **Material:** Heavy duty 5mm steel
- > **Rubber sleeve** to protect the barbell sleeve



Weight 7Kg Category F1



14,5x7x106cm

43932

\$ 345,80

FULL Commercial Grade

Dumbbell Rack

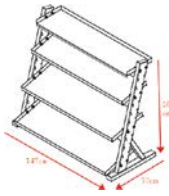

- > **Tube:** 70x50x2mm
- > **Capacity:** About 50 dumbbells
- > **Very flexible:** Can be used for all different types of dumbbells and kettlebells



+ The height and incline of the shelves can be adjusted

Capacity 800 Kg | per shelf 250 Kg | Weight 84kg | Category F2

147x70x107cm

43937

\$ 213,00

Semi-Commercial Grade

Rack

- > **Tube:** 50x70x1.5mm
- > Suitable for small gyms
- > Can be used for dumbbells, kettlebell and disks on the bottom rack
- > Hanger for large loop bands



Capacity 600 Kg | per shelf 250 Kg | Weight 30kg | Category F1

171x62x128cm

43938

\$ 128,00

Rack

- > **Tube:** 50x70x2mm

The shelves are **DOUBLE-SIDED**, one for bumbells and the other for kettlebells and can be assembled any way you want



Capacity/shelve 250 Kg | Weight 32 Kg | Category F1

111x56x83cm

43954

\$ 151,90

Semi-Commercial Grade

Chromed Dumbbell Rack EX

- > **Max weight:** 150kg



Weight 31 Kg | Category F1

166x53x81cm

43939

\$ 129,00

> For 10 pairs

Dumbbell Rack



Capacity 300kg Weight 21 Kg Category F1

55x27x126cm

43957

\$ 76,90

> Tube: Square 45x1.5mm
> For 20 vinyl dumbbells

Vinyl Dumbbell Rack



Weight 10 Kg Category D7

64x53x118cm

43923

\$ 343,80

FULL Commercial Grade

Primo Robur Dumbbell Rack



SPECS

Dimensions: 220,0x76,0x83,0 cm
Tubes: 97x50x2,0 mm
Strength: 600,0 kg
Weight: 64,0 kg
Category: F1

43945

\$ 139,00

Semi-Commercial Grade

Kettlebell Rack

> Tube: Oval 80x40x1.8mm



Weight 36 Kg Category F1

120x52x85cm

43951

\$ 101,50

Storage Rack Blaze

For Medicine and Slam Balls

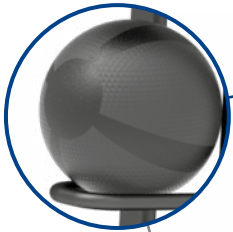

Balls

Max diameter that can be placed: 273mm

Constructions

One-piece shelves, offering increased robustness and better load distribution

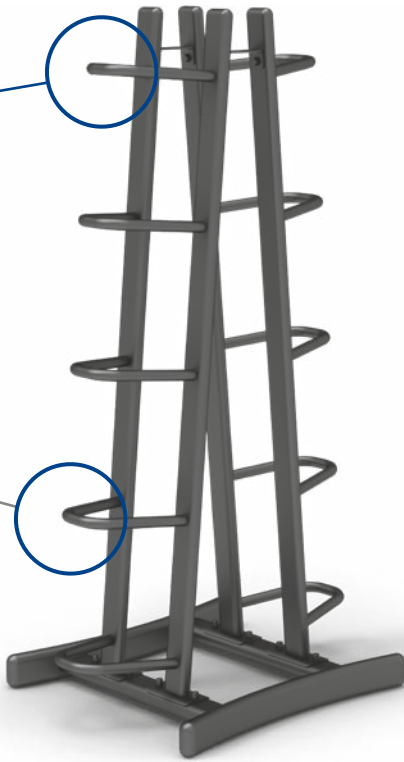

SPECS

Dimensions: 84,0x65,0x157,0 cm

Tubes: 30x70x1,5 mm

Strength (total): 300,0 kg

Strength (per shelf): 40,0 kg

Weight: 22,0 kg

Category: F1

43928

\$ 114,50

Single Balance Ball Rack

- > **Frame:** Oval 80x40mm, 1,8mm thick
- > **Shelves:** Ø25x2mm
- > **Capacity:** 5 balls

+ Can also be used for Power Bags



Weight
35Kg

Category
F1

67x80x170cm

43929

\$ 139,90

Double Balance Ball Rack

With wheels

- > **Frame:** Square 30x30mm, 1,5mm thick
- > **Capacity:** 14 balls



Category
F1

64x125x199cm

- > **Material:** Canvas
- > **Filling:** Chromed dowels which do not rust

AMiLA® Wrist/Ankle Weights

With Velcro.
Weight adjusted by dowels.



27,5x15cm

PCS 2 Category E1

CODE	PRICE	WEIGHT
44140	\$ 11,90	2x1,50 Kg
44141	\$ 14,35	2x2,00 Kg

- > **Material:** Neoprene
- > **Filling:** Sand iron - Barite

Ankle & Wrist Weights

With Velcro



PCS 2 Category E1

CODE	PRICE	WEIGHT
44114	\$ 3,40	2x0,50 Kg
44116	\$ 7,00	2x1,50 Kg

- > **Material:** Neoprene
- > **Filling:** Sand iron

AMiLA® Wrist Weights

Ideal for training and physiotherapy



PCS 2 Category E1

CODE	PRICE	WEIGHT
44130	\$ 4,80	2x0,50 Kg
44131	\$ 5,30	2x1,00 Kg

- > **Material:** Nylon
- > **Filling:** Sand iron - Barite

Ankle & Wrist Weights

With Velcro.
Fixed (not adjustable).



PCS 2 Category E1

CODE	PRICE	WEIGHT
44168	\$ 13,30	2x4,00 Kg

Ankle & Wrist Weights

With Velcro.
Fixed (not adjustable).



Material: Neoprene, filled with Sand iron and Barite

Very soft, nice feel, protects the body

CODE	PRICE	WEIGHT
94951	\$ 3,70	2x0,50 Kg
94952	\$ 5,25	2x1,00 Kg
94953	\$ 6,65	2x1,50 Kg
94954	\$ 8,60	2x2,00 Kg
94955	\$ 11,95	2x3,00 Kg

PCS 2 Category E1

- > Adjustable weight
- > Fabric: Neoprene
- > Filling: Iron sand bags

Wrist/Ankle Weights



Weight
Adjustable with removable bags

CODE	PRICE	WEIGHT
44149	\$ 9,70	2x2,50 Kg

PCS 2 Category E1

Ankle & Wrist Weights



CODE	PRICE	WEIGHT
44105	\$ 9,30	2x2,50 Kg
44106	\$ 15,30	2x5,00 Kg

PCS 2 Category E1

AMILA® HYDROBAG

Why should I use a HYDROBAG;

It is the perfect tool to help you correctly work-out your body and keep in shape! While it looks like an ordinary PowerBag, the use of water makes it unique!

The Power of Water

You can achieve a more intense and effective training when compared to traditional PowerBags. The water movement inside will energize your stabilizer muscles.

High Quality

Made of high quality PVC 1,0 mm thick for durability. Printed lines are useful when filling it with water to better calculate its weight, while at the same time you can use the pump to fill the remaining space with air.

Multiple handles

Equipped with four (4) anti-slip handles, with neoprene covering, to be able to exercise many muscle groups.

A safety valve prevents water leakage



INCLUDES
WATER COLOURING LIQUID

* Due to the elasticity of the material and the pressure of the pumped air, the dimensions are approximate.

> **Material:** Cordura with foam padding, double velcro and double zipper, barrel bag with double velcro



Category
F1

CODE	PRICE	WEIGHT
90671	\$ 25,90	15 Kg
90672	\$ 29,90	20 Kg



CODE	PRICE	WEIGHT	DIMENSIONS	COLOR
90661	\$ 22,20	15kg	Ø15x80cm	Red
90662	\$ 24,15	20kg	Ø18x82cm	Green
90663	\$ 25,90	35kg	Ø23x85cm	Blue

Category
F1

Soft Bags



> **Bag:** To be filled by sand and/or other materials. The bag is then placed inside the bucket; guaranteed leak proof and weight adjustment.

> **Outer surface:** Thick reinforced nylon fabric to prevent tearing. Reinforced straps for carrying out exercises. Zip closure. Transport handle.



> **Bucket:** Internal soft container to keep the sand unmovable and minimize injuries, bag fastened with straps.

> **Design:** Codes 90677 and 90678 with new design and colors



> With 4 grips

CODE	PRICE	COLOR	WEIGHT	LENGTH	DIAMETER
90675	\$ 35,30		5,00 Kg	50,0cm	18cm
90676	\$ 38,75		10,00 Kg	54,5cm	22cm
90677	\$ 40,50		15,00 Kg	54,5cm	22cm
90678	\$ 46,90		20,00 Kg	60,0cm	26cm
90679	\$ 46,90		25,00 Kg	60,0cm	26cm



SCAN HERE to view a sample video of exercises on our YouTube channel.



> Grips: 2 grips



+ Superb durability

> With 2 grips

CODE	PRICE	COLOR	WEIGHT	LENGTH	DIAMETER
37320	\$ 32,17		5,00 Kg	50,0cm	18cm
37323	\$ 41,23		20,00 Kg	60,0cm	26cm
37324	\$ 40,55		25,00 Kg	60,0cm	26cm

Category F1

BullBag



Handles
Ergonomic handles that withstand the most demanding workouts

Straps
Triple-woven straps for exceptional durability and removable pads to reduce pressure on the palms

GEL
Special GEL on the neck, enclosed in perforated leather, reduces friction for even greater comfort with every movement

SPECIFICATIONS

Dimensions: 72x46x20 cm
Material: External: PVC
Internal: Cotton, yellow sand & iron sand
Handles: PE
Std Pack: 1
Category: F1

CODE	PRICE	WEIGHT
90664	\$ 24,95	5 kg
90665	\$ 27,30	10 kg
90666	\$ 29,55	15 kg
90667	\$ 31,70	20 kg
90668	\$ 34,10	25 kg

They should not be dropped!
ATTENTION: They are not Smash Bags. They are used during exercises which do not require to let the bag be dropped down.

Weight Bag



CODE	PRICE	COLOR	WEIGHT
44661	\$ 20,85	Yellow	5,00 Kg
44662	\$ 26,80	Green	10,00 Kg
44663	\$ 32,80	Blue	15,00 Kg
44664	\$ 39,10	Red	20,00 Kg
44665	\$ 46,90	Black	25,00 Kg

57x22cm

Category
F1



Category E3

ATTENTION: They are not Wall Balls. Not to be dropped down!

- > **Material:** 40% primary rubber
- > **Joins:** Glued
- Very grippy texture

"Grip" Medicine Ball

CODE	PRICE	WEIGHT	DIAMETER	COLOR
84751	\$ 8,10	1,0Kg	—	Yellow
84752	\$ 10,30	2,0Kg	—	Orange
84753	\$ 13,10	3,0Kg	—	Teal
84754	\$ 15,55	4,0Kg	—	Red
84755	\$ 18,60	5,0Kg	—	Blue
84756	\$ 21,90	6,0Kg	—	Purple
84757	\$ 25,20	7,0Kg	—	Red
84758	\$ 27,40	8,0Kg	—	Brown
84759	\$ 29,90	9,0Kg	—	Grey
84760	\$ 32,35	10,0Kg	—	Black



Category E3

ATTENTION: They are not Wall Balls. Not to be dropped down!

- + Very nice tacky feeling

- > **Material:** Natural rubber
- > **Joins:** Glued

Medicine Ball

CODE	PRICE	WEIGHT	DIAMETER	COLOR
90708	\$ 27,55	4,0Kg	25,5cm	Green
90709	\$ 29,66	6,0Kg		Yellow
90710	\$ 31,77	8,0Kg		Purple
90711	\$ 36,13	10,0Kg		Grey



> **Material:** Rubber
> **Joins:** Glued

Medicine Ball Rebound

- Soft feel and light rebound
- + The only ones that can be dropped down without being smash balls

Category E3



SCAN HERE  to view a sample video of exercises on our YouTube channel.

CODE	PRICE	WEIGHT	DIAMETER	COLOR
44640	\$ 27,40	6,0Kg	22,5cm	
44634	\$ 32,00	7,0Kg	27,0cm	
44641	\$ 32,50	8,0Kg	27,0cm	
44642	\$ 40,90	10,0Kg	27,0cm	



ATTENTION: They are not Wall Balls. Not to be dropped down!

Dual Grip Medicine Ball

Category E3

> **Material:** Rubber

CODE	PRICE	WEIGHT	DIAMETER	COLOR
84676	\$ 20,00	3,0Kg	22,0cm	
84677	\$ 24,00	4,0Kg	23,0cm	
84673	\$ 36,50	8,0Kg	26,0cm	
84674	\$ 43,50	10,0Kg	28,0cm	
84675	\$ 49,20	12,0Kg	28,0cm	

Medicine Ball



ATTENTION: They are not Wall Balls. Not to be dropped down!

> **Material:** PVC
> **Joins:** Stitched

CODE	PRICE	WEIGHT	DIAMETER	COLOR
44511	\$ 6,50	1,0 Kg	16,0cm	Red
44512	\$ 7,45	2,0 Kg	18,5cm	Red
44513	\$ 8,65	3,0 Kg	21,3cm	Red
44514	\$ 10,50	4,0 Kg	24,5cm	Red
44515	\$ 12,00	5,0 Kg	—	Red

70262

\$ 149,00

Plyorebounder for Medicine Balls



73×70×150cm

Weight 12.5 Kg Category F1



Plexus Slam Ball



SPECIFICATIONS

Diameter: 22cm
 Material: PVC 3mm
 Filling: Sand
 Std Pack: 1
 Category: E3

CODE	PRICE	WEIGHT	COLOR
90810	\$ 6,40	3,00 kg	
90811	\$ 7,50	5,00 kg	
90812	\$ 8,50	6,00 kg	
90813	\$ 10,25	8,00 kg	
90814	\$ 12,25	10,00 kg	
90815	\$ 14,10	12,00 kg	
90816	\$ 19,65	15,00 kg	

Slam Ball



- > **Material:** PVC 3mm
 - > **Filling:** Sand
- Improved production process, which ensures
- + Greater durability
 - + Waterproof
 - + Low price

CODE	PRICE	WEIGHT	COLOR
90803	\$ 6,40	3,00 Kg	
90804	\$ 7,50	5,00 Kg	
90808	\$ 14,10	12,00 Kg	
90809	\$ 19,65	15,00 Kg	

Category
E3

- > **Shape:** Hexagon
- > **Material:** Nylon & Neoprene
- > **Filling:** Sand

Soft Grip Discs



CODE	PRICE	WEIGHT	COLOR
90751	\$ 7,40	2,0Kg	Purple
90752	\$ 7,80	4,0Kg	Green
90753	\$ 9,30	6,0Kg	Pink
90754	\$ 10,90	8,0Kg	Yellow
90755	\$ 12,00	10,0Kg	Red
90756	\$ 13,70	12,0Kg	Blue

Category
F1

Floss Wall Ball



- > **Material:** Rubber
- > **Weight:** ±50gr
- > **Filling:** Metal chips and/or sand, in order to have the same size with different weights

- + Precisely weighed, with a predictable course
- + Small diameter, easy to use and grip
- + Soft
- + Resistant to impact on the wall
- + For all these reasons, they are the best suited for use as a wall ball

> The best 28cm wall balls available

CODE	PRICE	WEIGHT	COLOR
94623	\$ 38,00	3,00Kg	Black
94625	\$ 44,90	5,00Kg	Black

Category
E3

Wall Ball



Category
E3

- > **Material:** Rubber
- > **Diameter:** 35cm

- + **Usage:** On the wall, but also good durability when dropped/smashed
- + Great endurance
- + Soft texture
- + Excelent protection

CODE	PRICE	WEIGHT	COLOR
84741	\$ 27,40	4,00 Kg	
84746	\$ 28,40	5,00 Kg	
84743	\$ 37,90	10,00 Kg	
84745	\$ 42,00	12,00 Kg	

Wall Ball



Category
E3

- > **Material:** PU
- > **Diameter:** 34cm

CODE	PRICE	WEIGHT	COLOR
94601	\$ 32,00	5,00 Kg	Black
94602	\$ 32,70	8,00 Kg	Black
94603	\$ 33,00	10,00 Kg	Black

Wall Ball



Category
E3

- > **Material:** Vinyl covered Nylon
- > **Filling:** Rubber and PP fabric
- > **Diameter:** 35cm

CODE	PRICE	WEIGHT	COLOR
90759	\$ 23,90	4,00 Kg	Black
90760	\$ 25,50	6,00 Kg	Black
90761	\$ 27,12	8,00 Kg	Black
90762	\$ 28,62	10,00 Kg	Black
90763	\$ 29,21	12,00 Kg	Black
90764	\$ 30,87	14,00 Kg	Black

95 150

\$ 29,90

- > **Discs:** 2 x 1.25kg
2 x 2.50kg
2 x 5.00kg
- > **Bar:** 1400x25mm hollow with rubber grip and spring collars
- > **Filling:** Cement with iron



25mm
Pump Set

Plasticized discs

Weight
17,5kg

Category
E1

444 17

\$ 11,90

- > **Bar:** 1300x28mm hollow with soft grip (32-34mm) and spring collars, 1,50kg



28mm
Pump Set
Bars



28mm
Rubber Covered
Disks

- > **Material:** Rubber
- > **Ring:** Nylon
- > Suitable for Ø28mm bars
- > **Shape:** All disks are polygonal in shape, greatly aiding when handling them

CODE	PRICE	WEIGHT	COLOR
44414	\$ 3,25	1,25 Kg	Yellow
44415	\$ 6,45	2,50 Kg	Blue
44416	\$ 12,90	5,00 Kg	Red

444 18

\$ 15,90

- > **Bar:** 1300x28mm with rubber grip and spring collars, 2,25kg



Category
E1

44439

\$ 12,10

- > **Bar:** 1300x30mm hollow with soft grip and spring collars



30mm
Pump Set
Bar



30mm
Rubber Covered
Disks

- > **Material:** Rubber
- > **Ring:** Nylon
- > Suitable for Ø30mm bars
- > **Shape:** All disks are polygonal in shape, greatly aiding when handling them

CODE	PRICE	WEIGHT	COLOR
84515	\$ 3,25	1,25 Kg	Red
84516	\$ 6,45	2,50 Kg	Yellow
84517	\$ 12,90	5,00 Kg	Green

Category
E1

95106

\$ 28,95

Adjustable straps

Ensure a secure fit and comfort, allowing the vest to adapt perfectly to any body type

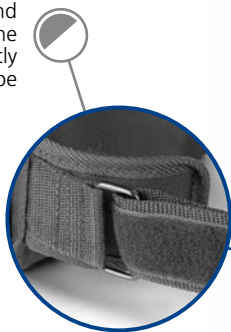

"Raw Vigor" Weighted Vest

(Sold without weights)

Velcro

Velcro panels on the front provide space for attaching pouches and modular accessories

95107

\$ 7,15

Weight Sticks

(Set of 5)



SPECS

Material: Cordura
 Number of Weights: Up to 30
 Std Pack: 1
 Category: E1

SPECS

Pcs: 5
 Material: Cast iron
 Weight: 950 gr
 Std Pack: 1
 Category: E1

84680

\$ 46,60

- > **Weights:** 10kg adjustable, 8 pcs in front and 8 pcs in the back
- > **Packing:** Box
- > **Material:** Front: Nylon
Back: Neoprene
- > **Weight:** Cilicone Jel

- + Supreme quality, absolute protection and comfort
- + Doesn't press or injure the shoulders
- + Compact and uniform performance when exercising
- + The best vest for running



Weighted Vest

Internal weights. Adjustable.



Std Pack 2
 Category D10

W45xH43cm

84640

\$ 35,50

- > **Weights:** 10kg adjustable, 16 pcs in front and 22 pcs in the back
- > **Packing:** Box

- Improved
- Soft weights
- Better fit
- Ideal for runners



Weighted Vest

Internal weights. Adjustable.

44160

\$ 27,40

- > **Weights:** 0,5kg x 20 pcs **removable**, 10 pcs in front and 10 pcs in the back
- > **Packing:** Box

"Core Trax" Weighted Vest

Internal weights. Adjustable.



Std Pack 2
 Category E1

W46xH45cm



95101

\$ 50,80

- › **Material:** Oxford 600D
- › **Length:** 38cm
- There are also 4 x 3cm sponge pads in the back combined with a breathable sandwich net, allowing the trainer to cushion the back, making it softer and more absorbent, relieving pressure on the back.
- Easily adjustable shoulder strap offers added comfort and better fit, while the joint also is reinforced.

Weight	Max-Weight	Category
1,65Kg	15Kg	E1



- Each (front or back) weight pocket can easily accept 2 pcs of the biggest (and thickest) plate, so you can easily add a weight of 25 kgs.



- Because of the novel design and then the steel plate's reinforcement, the vest is more stable on the body, does not fall off during exercising, it is firm and does not shake, ensuring safety and does not affect the center of gravity stability.

!!! Priced per item, sold per pair **Plates**

CODE	PRICE	WEIGHT
95102	\$ 4,80	1,70 kg
95103	\$ 6,90	2,60 kg
95104	\$ 10,20	4,00 kg
95105	\$ 15,90	6,20 kg

TACTICAL BACKPACK 2.0 & WARRIOR'S BAG

The renewed backpacks are made for your daily and also the most demanding activities. AMILA TACTICAL backpacks are made of high-quality, extremely durable materials and equipped with top-quality zippers. These backpacks boast a huge capacity, capable of storing all the necessary items for any activity.



Straps
Adjustable chest and waist straps

Velcro
Uniform surface

Zippers
Japan made YKK® zippers with an emphasis on detail

Pocket
For bottles

Molle
Laser cut Molle system

Compartment
Special compartment for your shoes

Why do we love them?

There aren't many backpacks that are this big, strong and sturdy. They are made of water-proof Oxford polyester fabric (600D), covered with PVC on the inside.

Learn more about the Amila Tactical backpacks at www.amila.gr or scan the QR-code



Advantages of BACKPACK 2.0

The new, updated backpacks are equipped with bottle holders, adjustable chest and waist straps, multiple pockets for better organization and storage, Japanese YKK® zippers with two-way opening, ergonomically designed adjustable compression straps, dedicated laptop/device (up to 17") compartment which opens up to 180 degrees for easy packing/unpacking, single Velcro surface to put the patches you want, new laser cut Molle system for a "cleaner" look, and a more durable webbing system.

Advantages of WARRIOR'S BAG

The backpack is equipped with a dedicated shoe compartment, external perforated pocket with elastic closure, adjustable shoulder strap, two handles, multiple internal pockets for better organization and storage, Japanese YKK® zippers with two-way opening, single velcro surface to put patches you want, new laser cut Molle system to attach whatever you want.

95353

\$ 1,21

Set Carabiner

SPECS

Dimensions: 8,4x5,6cm
Pcs: 2
Material: POM
Std Pack: 100
Category: F1



Bottle Holder

Molle
Molle system with laser cut

Material
Nylon 1000D

Dimensions
Ø9x24cm



CODE	PRICE	COLOR
95351	\$ 6,10	Black
95352	\$ 6,10	Olive

Patch



95354

\$ 1,46

Extendable Key Ring

SPECS

Dimensions: 12,5x4cm
Material: ABS + Ατσάλι
Std Pack: 126
Category: F1



CODE	PRICE	PRINT	SIZE
95343	\$ 0,48	"No pain no gain"	8x5,5cm
95344	\$ 0,48	"Coach"	8x2,5cm
95345	\$ 0,48	"Athlete"	8x2,5cm
95346	\$ 0,48	"AMILA tactical"	8x5,5cm

95347

\$ 24,30

Tactical 2.0 Backpack

Straps
Adjustable chest and waist straps

Pocket
For bottles

Velcro
Uniform surface

Zippers
Japan made YKK® zippers with an emphasis on detail

Molle
Laser cut Molle system

SPECS
Dimensions: 33,0x29,0x46,0 cm
NET weight: 1,47 kg
Material: 600D Oxford
Capacity: 45 L
Strap Material: Polyester 100%
Category: F1

95348

\$ 22,20

Tactical Backpack

Straps
Adjustable chest and waist straps

Pocket
For bottles

Velcro
Uniform surface

Zippers
Japan made YKK® zippers with an emphasis on detail

Molle
Laser cut Molle system

SPECS
Dimensions: 33,0x24,0x42,0 cm
NET weight: 1,15 kg
Material: 600D Oxford
Capacity: 28 L
Strap Material: Polyester 100%
Category: F1

95349

\$ 22,20

Warrior's Duffel Bag

Molle
Laser cut Molle system

Compartment
Special compartment for your shoes

SPECS
Dimensions: 56,0x25,0x26,0 cm
NET weight: 0,95 kg
Material: 600D Oxford
Capacity: 35 L
Strap Material: Polyester 100%
Category: F1

95340

\$ 13,90

Tactical Chest Bag

Back
Breathable fabric, with mesh

Compartments
Big, small and front pocket with inner divisions

SPECS
Dimensions: 18,0x13,0x23,5 cm
NET weight: 0,37 kg
Material: 600D Oxford
Capacity: 7 L
Strap Material: Polyester 100%
Category: F1

Agility Ladder

48581

\$ 7,55

> Adjustable distance

Length 4m
Pegs 10
Std Pack 10
Category D10

48589

\$ 12,90

> Adjustable distance

Length 9m
Pegs 21
Std Pack 6
Category D10



48586

\$ 7,55

> Colors: Red, white, blue, yellow
> Soft safe material



> Cross section on the upper part in order to support Ø25mm poles

> Priced and Sold: Per 40 pieces

PCS 40
Std Pack 12
Category D10



Ø19x5cm

Cone

Soft PVC.
With holes to bolt to the ground.

Cones

44024

\$ 1,85

Height 38cm

44023

\$ 1,27

Height 30cm

44022

\$ 0,57

Height 23cm

Std Pack 50
Category D10



Hurdles

Automatic bounce back

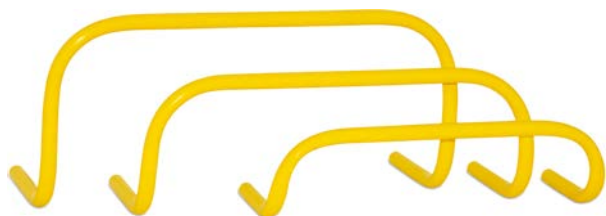

> Automatic bounce back: It returns back to its position when knocked down, thus eliminating time-breaks while doing drills.

Category D10

CODE	PRICE	HEIGHT	WIDTH
48604	\$ 4,55	20,00 cm	60,00 cm
48605	\$ 5,05	25,00 cm	60,00 cm
48606	\$ 6,55	30,00 cm	60,00 cm
48607	\$ 6,40	35,00 cm	60,00 cm
48608	\$ 7,40	40,00 cm	60,00 cm
48616	\$ 7,98	50,00 cm	60,00 cm
48617	\$ 8,84	60,00 cm	60,00 cm

Hurdles



Material PVC
Std Pack 20
Category D10

CODE	PRICE	HEIGHT	WIDTH
48588	\$ 2,83	41,00 cm	48,00 cm
48583	\$ 2,11	30,00 cm	48,00 cm
48587	\$ 1,89	23,00 cm	47,00 cm
48582	\$ 1,62	15,00 cm	46,00 cm

Tempo Plyometric Box



Premium details
Laser cut technique on the surface creates a textured and impressive appearance

Non-slip surface
The non-slip coating ensures absolute stability and grip, even during the most demanding exercises

CODE	PRICE	MATERIAL	HEIGHT	WEIGHT	STRENGTH	CATEGORY
84560	\$ 50,50	Laminated Eucalyptus and Poplar layers, 18mm thick, with anti-slip coating	40, 50, 60 cm	16,7 kg	300 kg	F1
84561	\$ 137,64		50, 60, 75 cm	24,0 kg		

Arc Gradus Plyometric Box



Assembly
It is pre-assembled, you can start using it immediately without

Comfort
The 1000D PVC cover ensures durability, while the 120D recycled sponge lining helps reduce vibrations

CODE	PRICE	LINING AND COVER	HEIGHTS	WEIGHT	STRENGTH	CATEGORY
95137	951695095	Lining from 120D recycled sponge, with 1000D PVC cover	40, 50, 60 cm	15,0 kg	—	F1
95138	952189095		50, 60, 75 cm	18,0 kg		

84559

\$ 123,70

> Heights: 51, 61, 76cm

- + Soft surface, absolutely safe regarding injuries
- + 3 different heights
- + Absolutely stable

> **Material:** High-durability vinyl on the outside, wood and EVA on the inside

84556

\$ 86,10

> Heights: 40, 50, 60cm



SCAN HERE to view a sample video of exercises on our YouTube channel.

Plyometric Box with soft surface



Strength 300Kg Category F1

95136

\$ 99,90

> Heights: 50, 60, 75cm
 > **Material:** Outer: Mat vinyl, Inner: Industrial type squeezed and PU foam

+ Fully assembled

Plyometric Box



Weight 16Kg Category F1

50x60x75cm

95131

\$ 559,00

> Heights: 15,3/30,5/45,7/61,0cm

- + Soft surface, absolutely safe
- + 4 boxes, each with a different height
- + Absolutely stable, connected with velcro
- + 1000D 0,65mm thick PVC cover over EVA with a hardness of ~30

Set of 4 Plyometric Boxes



Strength 200Kg Weight 50 Kg Category F2

76x91,5cm

Plyometric Boxes



Velcro
Huge Velcro strips secure them safely one on top of the other



Zipper
To remove the cover

CODE	PRICE	HEIGHT
95132	\$ 144,30	30,00 cm
95133	\$ 198,00	45,00 cm
95134	\$ 220,81	60,00 cm

SPECS

Shape: Hexagon
Width: 85cm from the middle of one side to the opposite one
Category: F1

48079

\$ 149,00

Power Fit Set



- » Very strong
- » Heavy duty
- » Absolutely stable

HEIGHT	PLATFORM	BASE
30,48 cm	33,02 cm	38,10 cm
45,72 cm	35,56 cm	45,72 cm
60,96 cm	38,10 cm	53,34 cm

SPECS

Category: F1

93706

\$ 92,00

Semi-Commercial Grade

Height Adjustable Squat Box

- » Non-slip checker plate top
- » Built to take extremely heavy loads
- » Easy pin and extra screw safety to adjust height (6 positions) in seconds.
- » Great for performing box squats, high box squats, lunges, step ups, split squats, front squats, body weight extensions, one leg squats and more.



SPECS

Dimensions: 57x47x28~40,6cm
Strength: 350 kg
Category: F1

Aerobic Bars



CODE	PRICE	WEIGHT
44156	\$ 12,15	2,00 kg
44157	\$ 14,50	3,00 kg
44158	\$ 17,00	4,00 kg
44159	\$ 21,50	5,00 kg

SPECS

Material: Metal covered with foam
Dimensions: 125cm x Ø25mm
Category: D10

95890

\$ 6,20

Revo Ball



SPECS

Category: E6

84554

\$ 64,90

- > **Material:** Polyester
- > **Cover:** Nylon
- > **Diameter:** 38mm
- > **Grips:** Aluminum

Length 15m Category F1



Battle Rope

- + More comfortable, with a better feel on the handle
- + Does not come off
- + No fear of getting scratched
- + Increased durability

84553

\$ 40,00

Length 9m Category F1



8455 1

\$ 62,70

- > **Material:** Polyester
- > **Cover:** Nylon
- > **Diameter:** 38mm
- > **Grips:** PVC covered

Length 15m Category F1



Battle Rope



- > Built with DuPont™ Kevlar®
- > Improve your blood circulation

> **Diameter:** 38mm

- + High traction grip
- + Targeted pressure points
- + Angle supported
- + Enduring handles

Battle Rope



Diameter 38mm Category F1

CODE	PRICE	LENGTH
95111	\$ 59,41	9,00 m

Battle Rope



- > **Material:** Polyester
- > **Iva:** 2mm
- > **Sleeve:** Without
- > **Diameter:** 38mm
- > **Grips:** PE covered, long lasting

CODE	PRICE	LENGTH
95113	\$ 20,90	9,00 m
95110	\$ 27,90	12,00 m
95114	\$ 32,80	15,00 m

Diameter 38mm Category F1

95308

\$ 31,20

- > **Material:** Manila
- > **Diameter:** 38mm



Climbing Rope

Length 7m Category F1

95311

\$ 10,20

- Heavy duty nylon supports
- Integrated padded elbow sleeve pockets
- Extra wide straps for the ultimate support
- Oversized D-ring connector to fit with any size bars in your gym
- Designed to minimize arm stress, helping to improve your technique

AB Sling



Category F1

83285

\$ 12,34

- > **Material:** Heavy-duty nylon
- > **Closure:** Velcro, easy to use
- + Cushions on the elbows for added comfort
- + Extra wide, for maximum support

AB Sling



Category F1

63x18,5cm

84552

\$ 15,50

- > **Handle:** ABS Ø2,8cm
- > **Strap:** 457x2,55cm

ABS Gym Rings

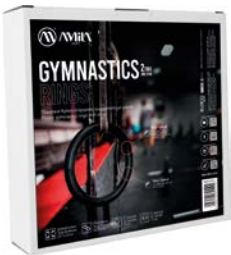

Category F1

84762

\$ 21,40

- > **Handle:** Birch Ø3,2cm, smooth, diameter 23,5cm
- > **Strap:** 457x3,80cm

Wooden Gym Rings



Category F1

43994

\$ 33,50

- > **Material:** Steel tube, Ø38x2mm

Parallette

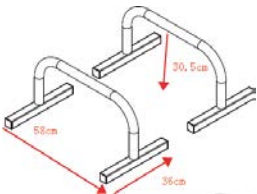

Weight 6,68 Kg

Strength 150Kg

Category E6

70264

\$ 39,20

- > **Color:** Yellow



70267

\$ 39,20

- > **Color:** Black



SCAN HERE 
Promo video on our YouTube channel.

- > **Max user weight:** 100kg

Weight 6,72 Kg

Strength 100Kg

Category F1

Equalizer



61x41x70cm

84631

\$ 64,90

> **Packing:** Paper box



Chin-up Rack

- > **Easy to install**
- > **Steel construction**
- > **Placement:** Wall and ceiling
- > **Width at end of grips:** 111cm
- > **Distance from the wall:** 60cm
- > **Grips:** Knurl
- > **Screws:** Expansion screws included
- > **Weight:** 13kg

Category
E6

84632

\$ 54,20

> **Packing:** Paper box



Chin-up Rack

- > **Easy to install**
- > **Steel construction**
- > **Placement:** Wall and ceiling
- > **Width at end of grips:** 116cm
- > **Distance from the wall:** 58cm
- > **Grips:** Rubber covered
- > **Bídes:** Expansion screws included
- > **Weight:** 9kg

Category
E6

84629

\$ 24,90

> **Packing:** Paper box



Elevor Chin-up Rack

- > **Easy to install**
- > **Steel construction**
- > **Placement:** Wall
- > **Width at end of grips:** 117cm
- > **Distance from the wall:** 38cm
- > **Grips:** Rubber covered
- > **Screws:** Expansion screws included
- > **Weight:** 4,5kg

Category
E6

44013

\$ 13,90



Locking mechanism
on both sides, made of ABS

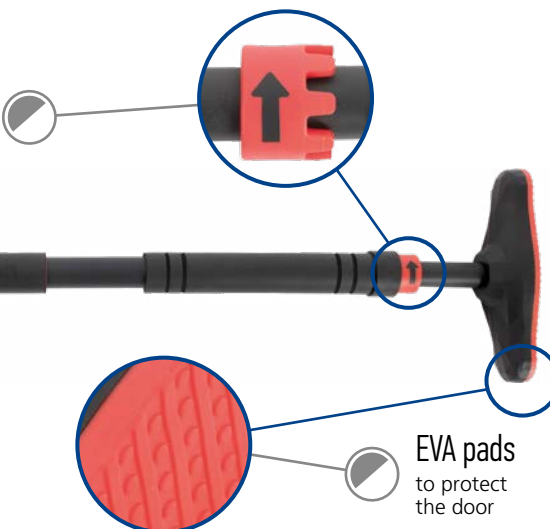

Soft grip
made of foam

EVA pads
to protect
the door

Pull-Up Bar

Adjustable

SPECS

Dimensions: 60-100 cm

Grip: Foam

Pads: EVA

Locking rings: ABS

Category: E6

43995

\$ 12,50

> Tubes: Ø28x2mm

> Packaging: Box

- Trains shoulders, biceps, triceps, back and ABS
- Foldable for immediate and easy storage

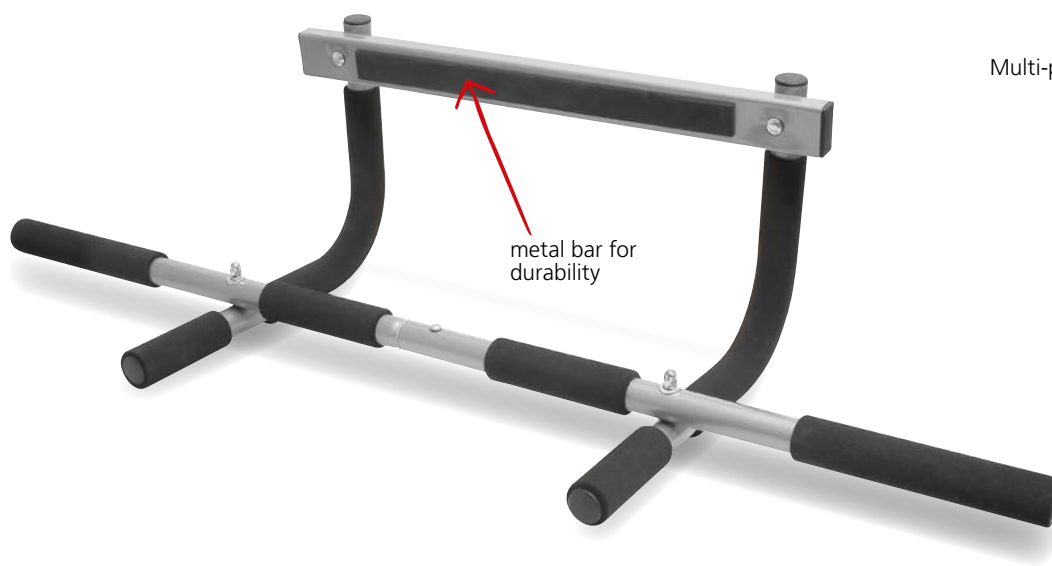

metal bar for
durability

Door Gym Multi

Multi-position door bar

Fe Steel	Weight 4 Kg	Std Pack 4	Category E6
-------------	----------------	---------------	----------------

44018

\$ 9,25



Horizontal bar

Chromed, with foam grip



Ø30, 630-930mm

Category
E6

44007

\$ 9,85



Horizontal bar

Chromed, with foam grip



Ø30, 630-930mm

Category
E6

44071

\$ 5,25

- » The different grip positions (11) allow you to train various muscles
- » Easy to fold

SPECIFICATIONS

Dimensions: 82x20x10 cm
 Material: PP & TPR
 Weight: 1,2 kg
 Std Pack: 10
 Category: E6

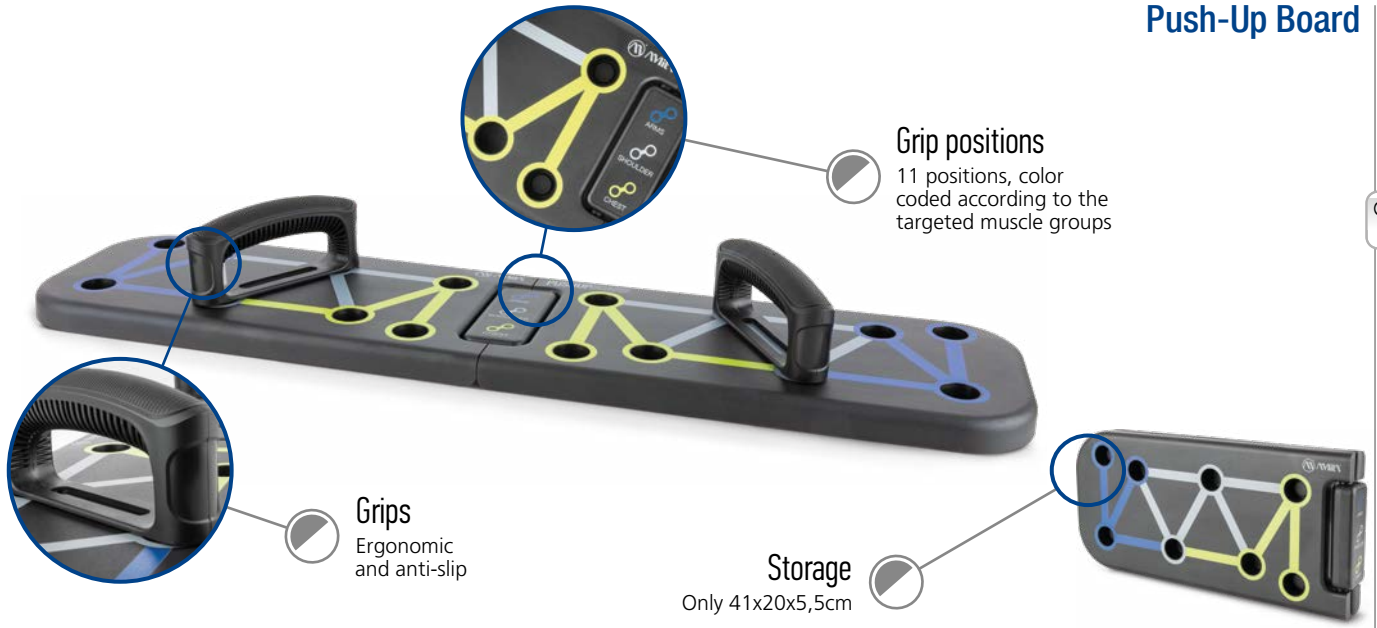

Push-Up Board

Category F1

43993

\$ 13,80

- » **Material:** Plastic

Perfect Push-up

Rotating



PCS 2 Category E6

44010

\$ 5,50

- » **Material:** PP, foam covered grips
- » **Base:** Anti-slip made of TPR

"Bionic" Push-up Stand



PCS 2 Std Pack 20 Category E6

44009

\$ 7,10

- » **Material:** Plastic base, metallic body, foam covered grips

Push-up Stand



PCS 2 Std Pack 20 Category E6

Gliding Pads



CODE	PRICE	COLOR
95951	\$ 3,90	Black
95952	\$ 3,90	Pink
95953	\$ 3,90	Grey
95954	\$ 3,90	Green

- » **Sides:** 2
- » **Material:** EVA (hard surfaces)
ABS (carpeted surfaces)

PCS 2 Diameter 18cm Category E6

44082

\$ 3,98

Exercise Wheel

Wheel

Extra-wide single wheel with ergonomic handles



SPECIFICATIONS

Dimensions: 29x18 cm
 Material: PVC
 Weight: 0,48 kg
 Grip: 12 cm
 Wheel: Diameter: 18 cm
 Width: 5 cm
 Std Pack: 20
 Category: F1



44072

\$ 4,30

Exercise Wheel

Wheels

Two, for increased stability

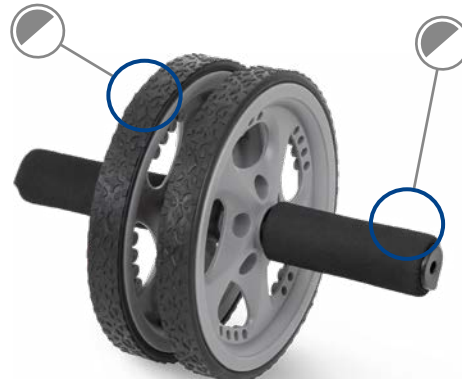

Grips

Covered with foam



Weight 550gr

Category F1

18x28cm

44074

\$ 26,30

Exercise Wheel

- > Handle length: 55cm
- > Wheel diameter: Ø35,5cm
- > Wheel width: 4cm



Category F1

35,5x55cm

44049

\$ 3,55

Double Exercise Wheel



SPECIFICATIONS

Dimensions: 28,5x18 cm
 Material: PP & TPR
 Weight: 0,45 kg
 Grip: 10 cm
 Wheel: Diameter: 18 cm
 Width: 2,3 cm
 Std Pack: 10
 Category: D10



Grips

Comfortable 10 cm long grips from TPR, offer a secure hold

Wheel

Silent and slip-resistant

44035

\$ 7,00

Chest Expander

With spirals

- > Material: Chrome
- > Springs: 5 metallic



Length 55cm

PCS 1

Weight 1Kg

Category E6

44003

\$ 5,10

Chest Expander

Made of rubber. Ideal for women and kids.

- > Material: TPR



Length 1m

Std Pack 12

Category D10

44204

\$ 25,70

AB Roller

The best instrument for people with waist problems, who need to perform exercises painlessly and efficiently

- > Tube: Ø25x1.2mm
- > Packaging: Box
- > Reinforced frame



Std Pack 5

Category D7

74x68x70cm

> Grip: Anodized aluminium

Handgrips



CODE	PRICE	SPRING	RESISTANCE
44086	\$ 4,25	5,5mm	100lbs / 45kg
44087	\$ 4,38	6,0mm	150lbs / 60kg
44088	\$ 4,57	6,5mm	200lbs / 90kg
44089	\$ 4,80	7,0mm	250lbs / 115kg

PCS 1 Std Pack 50 Category E6

44037

\$ 8,05

TENSION Electronic Handgrip/ Dynamometer



Screen

LED, 16,5mm digit height and multiple user profiles

Wheel

To adjust the size of the grip

SPECS

Pcs: 1
 Range: Up to 90kg
 Weight: 156gr
 Battery: Rechargeable Lithium 3,7V/300mAh
 Charging: USB-C cable
 Std Pack: 25
 Category: D7



44001

\$ 2,00

Handgrips

Soft grips.

> Spring: **5,5mm**, a lot stronger than the others

> Material: Neoprene covered grips



44033

\$ 1,84

> Spring: 4,5mm



PCS 2 Std Pack 48 Category E6

44081

\$ 1,25

Handgrips

Adjustable



10-60kg

The resistance is easily adjusted by turning a knob

SPECS

Grip: Very robust, made of TPR
 Spring and internal mechanism: Made of steel
 Resistance: Adjustable 10-60kg
 Category: E6

44076

\$ 4,95

> Resistance: Adjustable 10-40kg

PCS 1 Std Pack 50 Category E6



The resistance is easily adjusted with the turn of a knob

44080

\$ 4,60

> Grip: Very robust, made of PP/TPR
 > Spring and internal mechanism: Made of steel
 > Resistance: Adjustable 10-40kg

PCS 1 Category E6



Handgrips

Adjustable

IMPROVED PRODUCT

84578

\$ 8,90

POWER SLIM

Speed Rope

- > Grips: Aluminum, 14cm length, Ø1,8cm diameter
- > Length: 3,00m
- > Cable: Ø2,6mm

- With highest quality bearings
- Excellent speed
- Adjustable length, the cable is stored inside the handle

Self-locking structure, no need to use a screwdriver to adjust the length



Category F1

84579

\$ 8,40

POWER GRIP

Speed Rope

- > Grips: Plastic, covered with sweatbands, 13cm length, Ø1,8cm diameter
- > Length: 3,00m
- > Cable: Ø2,6mm

- With highest quality bearings
- Excellent speed
- Adjustable length, the cable is stored inside the handle

Self-locking structure, no need to use a screwdriver to adjust the length



Category F1

44057

\$ 6,40

Jump Rope with Weights

With weights in the grips

- > Grips: Wrapped with sweatband
- > Length: 3,30m
- > Cable: Ø3,0mm

- > Length: 3,30m adjustable



- > Bearings: Type 608



- Removable weights, 130gr per grip

Category E6

44051

\$ 6,63

Speed Rope

ALUMINIUM

- > Grips: Aluminium
- > Length: 3,35m
- > Cable: Ø2,5mm

- > Length: 3,35m adjustable



Category E6



84575

\$ 6,35

- > Length: 3,00m
- > Cable: Ø2,5mm

- Friction metal-on-metal (metal sphere inside the metal head), long service life
- Adjustable length, the cable is stored inside the handle
- Removable weights, 40gr per grip

Category F1



> The cable is stored inside the handle

Speed Rope



> The cap of the grips is used as a screwdriver to adjust the length of the cable

84576

\$ 4,95

- > Length: 3,00m
- > Cable: Ø2,5mm

- Friction metal-on-metal (metal sphere inside the metal head), long service life
- Adjustable length, the cable is stored inside the handle

Category F1



> Friction metal-on-metal (metal sphere inside the metal head), long service life



Speed Rope



84577

\$ 4,30

- > Length: 3,00m
- > Cable: Ø2,4mm

- Without bearings
- Metallic bushing
- Excellent speed
- Shorter service life

Category F1



Speed Rope



84580

\$ 3,45

- > Grips: Plastic, 11,7cm length, Ø1,5cm diameter
- > Length: 3,00m
- > Cable: Ø2,6mm

- With good quality bearings
- Length adjustable with screws
- Adequate speed
- Adjustable length, the cable is stored inside the handle

Category F1



Speed Rope



44055

\$ 4,45

- > Length: 2,75m
- > Cord: Leather
- > Weights: 2 x 120g



Size 14cm Category E6

Jump Rope

With bearings and weights
LEATHER,
suitable for boxers

44069

\$ 4,40

- > Cord: Leather
- > Grips: Wooden



Size 24cm Category E6

Jump Rope

With bearings
LEATHER

44064

\$ 3,33

Jump Rope with Counter



Std Pack 48 Category E6

84558

\$ 2,25

Speed Rope "Aero"

- > Length: 3,00m
- > Cable: Ø2,4mm
- > Packaging: Blister



- With bearings



Category F1

44053

\$ 2,10

- > Dimension: 275cm
- > Grips: Soft
- > Weights: 2 x 120g
- > Packaging: Blister

Jump Rope with Weights



Std Pack 48 Category E6

44059

\$ 1,60

Jump Rope

With bearings

- > Dimensions: 0,52x275cm
- > Cable: Synthetic
- > Grips: Soft



Std Pack 48 Category E6

94902

\$ 16,50

> **Waist:** 77-95 cm



94903

\$ 16,50

> **Waist:** 87-105 cm



Leather Weight Lifting Belt

With pillow

- > **Material:** Genuine **Grade A** leather
- > **Width:** 10cm



8331002

\$ 14,50

> **Waist:** 80-98 cm



8331004

\$ 14,50

> **Waist:** 93-112 cm



Leather Weight Lifting Belt

With pillow

- > **Material:** Genuine **Grade A** leather
- > **Width:** 10cm
- > **Lining:** Suede



44301

\$ 14,00

> **Waist:** 77-96 cxm



44302

\$ 14,00

> **Waist:** 82-101



Leather Weight Lifting Belt

With pillow

- > **Material:** Genuine **Grade A** leather
- > **Width:** 10cm
- > **Lining:** Suede



94920

\$ 12,04

> **Waist:** 62-83cm



94921

\$ 12,04

> **Waist:** 70-90cm



Leather Weight Lifting Belt

With pillow

- > **Material:** Genuine **Grade B** leather
- > **Width:** 15cm
- > **Lining:** Suede



94906

\$ 10,95

> Waist: 67-84 cm

94907

\$ 10,95

> Waist: 77-95 cm

94908

\$ 10,95

> Waist: 85-103 cm

94909

\$ 10,95

> Waist: 98-115 cm

Leather Weight Lifting Belt

With pillow

- > Material: Genuine **Grade B'** leather
- > Width: 10cm



94915

\$ 22,15

> Length: 96 cm

94916

\$ 22,15

> Length: 105 cm

94917

\$ 22,15

> Length: 110 cm

94918

\$ 22,15

> Length: 115 cm

Leather Power Lifting Belt

- > Material: Genuine **Grade C'** leather
- > Width: 10cm
- > Lining: Suede



83336

\$ 10,00

> Waist: 76-94cm

83337

\$ 10,00

> Waist: 80-98cm

Leather Weight Lifting Belt

With pillow

- > Material: Genuine **Grade C'** leather
- > Width: 10cm
- > Lining: Suede



44305

\$ 10,20

> Waist: 78-96 cm

44306

\$ 10,20

> Waist: 83-102 cm

44307

\$ 10,20

> Waist: 88-106 cm

44308

\$ 10,20

> Waist: 95-113 cm

Leather Weight Lifting Belt

With pillow

- > Material: **Grade B'** split leather
- > Width: 10cm
- > Lining: Suede



94911

\$ 9,30

> **Waist:** 67-85 cm

94912

\$ 9,30

> **Waist:** 77-95 cm

94913

\$ 9,30

> **Waist:** 85-103 cm

94914

\$ 9,30

> **Waist:** 98-115 cm

Leather Weight Lifting Belt

With pillow

- > **Material:** Genuine **Grade C** leather
- > **Width:** 10cm



44326

\$ 8,50

> **Waist:** 79-93 cm

44327

\$ 8,50

> **Waist:** 87-101 cm

44328

\$ 8,50

> **Waist:** 98-110 cm

44329

\$ 8,50

> **Waist:** 110-120 cm

Weight Lifting Belt

The best belt with the ultimate protection

- + Special reinforcements fully support the area of the waist, protecting from injuries

> **Width:** 20cm



83332

\$ 6,80

> **Waist:** 77-92 cm

83333

\$ 6,80

> **Waist:** 89-103 cm

83334

\$ 6,80

> **Waist:** 97-111 cm

83335

\$ 6,80

> **Waist:** 100-117 cm

Predator

With pillow

- > **Material:** Neoprene
- > **Width:** 15 cm



44331

\$ 5,85

> **Waist:** 79-94 cm

44332

\$ 5,85

> **Waist:** 86-100 cm

44333

\$ 5,85

> **Waist:** 91-108 cm

Weight Lifting Belt

Velcro closure.

- > **Material:** Neoprene
- > **Width:** 13 cm



83280

\$ 6,33

Head Harness

- > **Material:** Nylon with Neoprene padding
- > **Chain:** 71cm
- > **Size:** One size

- Suitable for **heads** with a perimeter of 56-63cm



Category E3

94900

\$ 6,60

Dip Belt

- > **Material:** Neoprene
- > **Chain:** 71cm
- > **Size:** One size, adjusted by steel hook



8mm thick

Category E3

84x15,5cm

96631

\$ 7,89

Dip Belt



SPECIFICATIONS

- Dimensions: 80x10/15 cm
- Material: Soft nylon blend, 1cm thick
- Chain: Powder-coated iron, 77 cm long
- Weight: 1,05 kg
- Std Pack: 10
- Category: E3

44340

\$ 5,20

- > **Waist:** 80-87 cm

44341

\$ 5,20

- > **Waist:** 90-98 cm

44342

\$ 5,20

- > **Waist:** 100-109 cm

44343

\$ 5,20

- > **Waist:** 110-118 cm



Category E3



Curved Weight Lifting Belt

Velcro closure

- > **Material:** Neoprene
- > **Width:** 14 cm



44335

\$ 4,70

- > **Waist:** 66-78 cm

44336

\$ 4,70

- > **Waist:** 76-90 cm

44337

\$ 4,70

- > **Waist:** 86-101 cm

44338

\$ 4,70

- > **Waist:** 97-113 cm

44339

\$ 4,70

- > **Waist:** 107-122 cm



Category E3



Straight Weight Lifting Belt

Velcro closure

- > **Material:** Lycra + Neoprene
- > **Width:** 11 cm



Weight Lifting Gloves

- > **Palm:** Durable, weather resistant, soft and comfortable Amara leather with PU and ergo gel padding for extreme comfort and energy absorption
- > **Back:** Spandex for high flexibility, breathability and better fitting, with added rubber panels for maximum protection
- > **Closure:** Velcro with Neoprene wrist wrap



CODE	PRICE	SIZE
8330502	\$ 8,10	M
8330504	\$ 8,10	XL
8330505	\$ 8,10	XXL



- > **Palm:** Durable, weather resistant, soft and comfortable Amara leather with PU, ergo gel padding for extreme comfort and energy absorption and terry towel on thumb to wipe off sweat
- > **Back:** Lycra for high flexibility, breathability, internal airflow, quick dry and better fitting
- > **Closure:** Velcro
- > **Fingers:** Pull-off-tabs for easy removal and added elastic for better fitting and irritation avoidance

Weight Lifting Gloves



CODE	PRICE	SIZE
8330601	\$ 6,20	S
8330602	\$ 6,20	M



- > **Palm:** Durable, weather resistant, soft and comfortable Amara leather with PU, ergo gel padding for extreme comfort and energy absorption, and air mesh for maximum breathability
- > **Back:** Lycra for high flexibility, breathability and better fitting
- > **Closure:** Velcro
- > **Fingers:** Pull-off-tabs for easy removal and added elastic for better fitting and irritation avoidance

Weight Lifting Gloves



CODE	PRICE	SIZE
8330102	\$ 5,75	M
8330103	\$ 5,75	L



Weight-lifting Gloves

Female Fit
(sizes are smaller than the respective for males)



- > **Material:** Genuine leather
- > **Packaging:** Plastic bag with zipper

CODE	PRICE	SIZE
83231	\$ 8,43	M
83232	\$ 8,43	L



Weight Lifting Gloves

5cm elastic cuff



- > **Material:** Nappa leather and spandex on top, Amara suede leather on the palm, foam padding, double wrap wrist closure with velcro

CODE	PRICE	SIZE
83261	\$ 6,22	S



NuBuk



- > **Material:** NuBuk leather and Spandex for perfect fit

CODE	PRICE	SIZE
83258	\$ 5,59	L
83259	\$ 5,59	XL



Weight Lifting Gloves

5cm cuff



- > **Material:** Nappa leather and spandex on top, Amara leather on the palm, foam padding, double wrap wrist closure with velcro, extra velcro on the back

CODE	PRICE	SIZE
83255	\$ 5,70	M
83256	\$ 5,70	L
83257	\$ 5,70	XL



Weight Lifting Gloves



- > **Material:** Genuine goat leather + Spandex for a perfect fit

Completely filled with thick foam material at fingers/palm. Velcro clasp and elastic fastening offers better fit and grip at the wrists.

CODE	PRICE	SIZE
83250	\$ 4,50	S
83253	\$ 4,50	XL
83254	\$ 4,50	XXL



Weight Lifting Gloves

5cm cuff



- > **Material:** Genuine leather + Spandex
- > **Packaging:** Plastic bag with zipper

CODE	PRICE	SIZE
83238	\$ 4,50	M



- > **Material:** Amara on the inside and the outside
Foreway in between and on the thumb
- > **Silicon dots** for better grip
- > **Gel padding** on the inside
- > **Reflector tape** on the outside
- > **Neoprene closure**

Weight Lifting Gloves



CODE	PRICE	SIZE
8322701	\$ 4,85	S
8322702	\$ 4,85	M
8322703	\$ 4,85	L
8322704	\$ 4,85	XL
8322705	\$ 4,85	XXL

Category E3

- > **Material:** Amara on the inside
PU on the outside
Nylon mesh in between and on the thumb
- > **Gel padding** on the inside
- > **Closure:** PU

Weight Lifting Gloves



CODE	PRICE	SIZE
8322801	\$ 4,50	S
8322802	\$ 4,50	M
8322803	\$ 4,50	L
8322804	\$ 4,50	XL
8322805	\$ 4,50	XXL

Category E3

- > **Material:** Amara on the inside
Suede on the outside
Foreway in between and on the thumb
- > **Gel padding** on the inside
- > **Reflector tape** on the outside
- > **Big closure**

Weight Lifting Gloves



CODE	PRICE	SIZE
8322601	\$ 4,50	S
8322602	\$ 4,50	M
8322603	\$ 4,50	L
8322604	\$ 4,50	XL
8322605	\$ 4,50	XXL

Category E3

- >> Gel padding on the inside
- >> Reflector tape on the outside
- >> Big closure

Weight Lifting Gloves



SPECS

Material: Amara on the inside
Suede on the outside
Foreway in between and on the thumb

Std Pack: 75
Category: E3

NEW logo



CODE	PRICE	SIZE
44615	\$ 5,60	M

- > **Material:** Amara on the inside
PU on the outside
Nylon mesh in between and on the thumb
- > **Gel padding** on the inside
- > **Closure:** PU

Weight Lifting Gloves



CODE	PRICE	SIZE
8322901	\$ 4,50	S
8322902	\$ 4,50	M
8322903	\$ 4,50	L
8322904	\$ 4,50	XL
8322905	\$ 4,50	XXL

Category
E3

- >> Gel padding on the inside
- >> Closure: PU

Weight Lifting Gloves



NEW logo

CODE	PRICE	SIZE
95601	\$ 5,50	S
95602	\$ 5,50	M

SPECS

Material: Amara on the inside
PU on the outside
Nylon mesh in between
and on the thumb

Std Pack: 125

Category: E3

Weight Lifting Gloves



CODE	PRICE	SIZE
8322501	\$ 4,25	S
8322503	\$ 4,25	L
8322504	\$ 4,25	XL
8322505	\$ 4,25	XXL

- > **Material:** Combination of Genuine Leather and Amara
- > **Silicone** dots on the fingers for better grip
- > **Silicone** padding on the inside
- > **Neoprene** closure

Category
E3

- >> Silicone dots on the fingers for better grip
- >> Silicone padding on the inside
- >> Neoprene closure

Weight Lifting Gloves



NEW logo

CODE	PRICE	SIZE
44611	\$ 7,10	S
44612	\$ 7,10	M

SPECS

Material: Combination of Genuine
Leather and Amara

Std Pack: 75

Category: E3

Weight Lifting Gloves

Weight Lifting Gloves



- >> Silicone padding on the inside
- >> Elastic closure



- > **Material:** Amara on the inside and the outside, Foreway in between the fingers
- > **Silicone** padding on the inside
- > **Elastic** closure



CODE	PRICE	SIZE
8322401	\$ 4,30	S
8322403	\$ 4,30	L
8322404	\$ 4,30	XL
8322405	\$ 4,30	XXL

Category E3

SPECS

Material: Amara on the inside and outside
Foreway in between the fingers
Std Pack: 75
Category: E3

NEW logo 

CODE	PRICE	SIZE
44604	\$ 4,75	S
44605	\$ 4,75	M
44606	\$ 4,75	L
44607	\$ 4,75	XL

- > **Material:** Nylon mesh with neoprene cushions
- > **Closure:** Velcro, easy to use

Palm Grips

- + Very comfortable
- + High durability
- Can replace traditional gloves



- The silicone pads in the palm provide great grip, extreme comfort and complete protection
- Ventilation is ensured by the large openings, while the velcro closure, with neoprene padding, provides firm grip on the wrist while at the same time offers great comfort

Palm Support Gloves



CODE	PRICE	SIZE
83288	\$ 2,90	S/M
83289	\$ 2,90	L/XL

Category F1

Category F1

CODE	PRICE	SIZE
8328404	\$ 4,00	XL
8328405	\$ 4,00	XXL

> **Material:** Thick, tri-color fabric, elastic, great durability

- Necessary when lifting heavy weights
- + Reinforces and stabilizes the wrist, reducing the risk of accidents

Wrist Wraps



Category E3

CODE	PRICE	LENGTH
83282	\$ 2,00	30,00 cm
83283	\$ 2,35	45,00 cm

83294

\$ 2,24

> **Material:** Cotton with padding
> **Packing:** Polybag

- Anti-slip surface for a secure grip

Power Straps



Category E3

83297

\$ 4,70

Power Straps

- 52cm long strap made of heavy duty cotton and grip flex rubber, gel padded wrist support 6mm, both 4cm wide



Category E3



83296

\$ 5,80

Power Straps

- 31cm long nylon strap with acrylic webbing for optimum grip and durability, neoprene padded wrist support 6mm thick and 6cm wide
- The strap is triple stitched perpendicular to the wrist support for secure and precise wrap around the bar
- Rugged stainless steel buckle



Category E3

83298

\$ 8,45

- The metallic lat hooks are used for strengthening the grip when performing heavy tensile exercises and exercises of abdominal muscles in hanging position on horizontal bar
- Customized fit around the wrist with adjustable velcro closure



Category
E3

Lat Hooks

83295

\$ 10,30

- Wrist band 6mm thick, 6cm wide, neoprene padded wrist support
- Coated durable metal hooks for a secure grip
- Great for lat pull downs, shrugs, pull ups, low rows and others back and shoulder exercises



Category
E3

Lat Hooks



SPECS

Height: 22 cm
Frame: Ø25x1,2mm
Legs: Ø25x1,8mm
Cover: 0.30mm PVC
Filling: 15mm Foam
Springs: 3mm
Max user weight: 80Kg
Packing: Box
Std Pack: 1
Category: D17

CODE	PRICE	COLOR	DIAMETER
70258	\$ 31,90	Black	Ø97
70259	\$ 37,50		Ø115

Τραμπολίνο

Tips & Tricks για γερά πόδια

Τα πόδια των προϊόντων **70260** και **70261** είναι βιδωτά στο πλαίσιο που στερεώνονται τα ελατήρια.

Λόγο των ανοχών που υπάρχουν έχει παρατηρηθεί πως η συχνή χρήση του τραμπολίνο δημιουργεί αναπόφευκτες φθορές στα σπειρώματα με αποτέλεσμα η δυνατότητα συγκράτησης τους σταδιακά να ελαττώνεται.

Για τη μέγιστη δυνατή αποφυγή ανάλογων συνεπειών προτείνουμε δυο διαφορετικές λύσεις που συνηθίζεται να χρησιμοποιούνται στις συναρμογές:

Ταινία Τεφλόν κ Υποκατάστατα

Η χρήση της ταινίας τεφλόν στα σπειρώματα είναι η πιο διαδεδομένη λύση **απαλοιφής των ανοχών** και στεγανοποίησης. Εκτός από την ταινία τεφλόν, στο εμπόριο υπάρχουν πλέον πολλά **υποκατάστατα** προϊόντα (**στεγανοποιητικό νήμα, υγρό τεφλόν κ.α.**) που κάνουν την εφαρμογή τους για την επίτευξη του επιθυμητού αποτελέσματος πραγματικό παιχνίδι.



Tip *

Το μυστικό βρίσκεται στη **σύσφιξη**. Με την εφαρμογή της κόλλας σπειρωμάτων πρέπει να σφίξουμε μέχρι να πατήσει η βίδα χωρίς δύναμη και μετά να σφίξουμε κατά 30 μόριες μόνο. Τα υπόλοιπα τα αναλαμβάνει η κόλλα, ανάλογα με τις ιδιότητες που έχει.

Η **κόλλα (ή ασφαλιστικό) σπειρωμάτων** είναι ειδικής σύνθεσης υλικό που γεμίζει τα κενά ανάμεσα στο σπείρωμα και στο πάσο. Στερεοποιούνται με την πλήρη απουσία αέρα ή την επαφή με το μέταλλο με την μορφή σκληρού θερμικού πλαστικού. Παράλληλα δε αυξάνουν κατά πολύ την τριβή μεταξύ των μερών που εφάπτονται δημιουργώντας ένα λεπτό στρώμα εξαναγκάζοντας τα συγκολλημένα μέρη να παραμένουν σταθερά. Για την μέγιστη απόδοση τα μέρη που θα γίνει η εφαρμογή θα πρέπει να είναι απόλυτα καθαρά από λάδια, γράσα κ.λπ.

Κόλλα Σπειρωμάτων



Τα είδη της Κόλλας Σπειρωμάτων

- **Χαμηλής Αντοχής** (συνήθως μπλε χρώματος): Εύκολη αποσυναρμολόγηση με εργαλεία χειρός.
- **Μεσαίας Αντοχής** (συνήθως κόκκινου χρώματος): Πιθανή αποσυναρμολόγηση με εργαλεία χειρός.
- **Μεγάλης Αντοχής** (συνήθως πράσινου χρώματος): Δύσκολη έως απίθανη αποσυναρμολόγηση με εργαλεία χειρός. Προϋπόθεση χρήσης εργαλείων θέρμανσης θερμοκρασία (>250°C). Αποσυναρμολογήστε και καθαρίστε όσο είναι ακόμα ζεστό.

FULL Commercial Grade

- > Height from ground: 32,5cm
- > Frame: Ø28,6x1,8mm
- > Legs: 25,4x1,5x560mm
- > Grip: Ø25,4x1,5x560mm
- > Lower support tube: Ø30x30x1,8x500mm
- > Upper support tube: Ø25x25x1,5x1000mm
- > Cords: 36 pcs
- > Mat: PP
- > Max user weight: 130Kg
- > Dimensions: 111,5 x 124 cm x 117~151cm
- > Packaging: Carton



MAXIMUM
user weight
130Kg

- Heavy duty
- Suitable for gyms

70269
\$ 9,60



Hexagon Trampoline
With handlebar

Frame/Cord Pad
Cover and protect the cords for your own safety and the trampoline's longevity

CODE	PRICE	COLOR
70263	\$ 103,70	
70265	\$ 103,70	
70268	\$ 95,00	

Weight **13,6kg** Std Pack **1** Category **F1**



44077

\$ 49,00

- > Anti-slip surface
- > **Material:** Extremely durable plastic
- > **Height:** 13, 18 & 22 cm

COMMERCIAL



Positions **3** Category **D10**

69x40cm

Aerobic Step

44027

\$ 21,10

- > Stable
- > Anti-slip surface
- > Ideal size
- > **Height:** 10, 15 & 20 cm
- > **Material:** Plastic



Positions **3** Std Pack **4** Weight **3,5Kg** Category **D10**

78x29cm

AMILA® Step
For personal use, without a personal trainer.



4403 1

\$ 11,95

“Lift” Aerobic Step

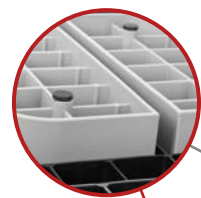

Storage
The 2nd legs can be stored underneath



Surface
Specially designed to not slip



Height
10 and 15 cm

SPECIFICATIONS

- Dimensions: 68x28 cm
- Use: Home
- Material: PP & TPR
- Height: 10 & 15 cm
- Weight: 2,35 kg
- Std Pack: 4
- Category: D10

44040

\$ 41,70

- > Anti-slip surface
- > Height: 15,5, 20,5 & 25 cm

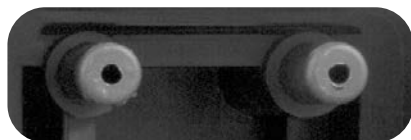
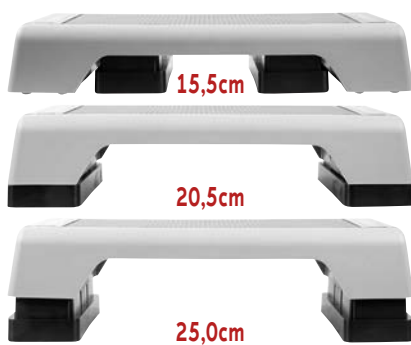

- > Rubber feet to protect to floor

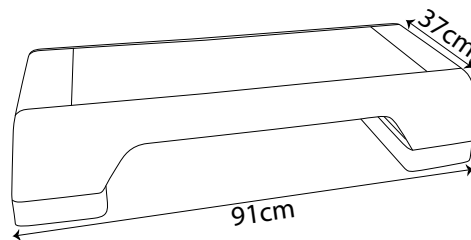

- > Rubber anti-slip surface 68x26,5cm

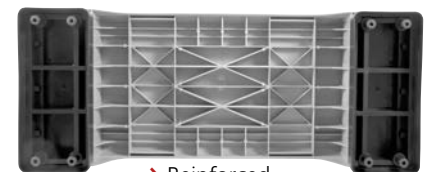

- > Reinforced construction

91x37cm

Aerobic Step

Positions	Weight	Category
3	6,9kg	D10

4823 1

\$ 12,50

- Without Latex, PVC, Phthalates and Chlorides

Balance Cushion



Category
D10

Ø36cm

95882

\$ 6,75

Balance Cushion with Handle



SPECIFICATIONS

Material: PVC
Diameter: 33 cm
Weight: 1,0 Kg
Std Pack: 10
Category: D10

48035

\$ 7,60

Balance Plate

Very good for the medium-level, but also for the demanding user. Weight of user up to 90kg.



Weight
6.3kg

Std Pack
6

Category
D10

Ø39.5x8cm

48049

\$ 14,30

- > 2 levels of difficulty
- > **Material:** P1P

Balance Plate

Very demanding (on the 2nd level), for experienced fit users. Weight of user up to 100kg.



1st difficulty level



2nd difficulty level

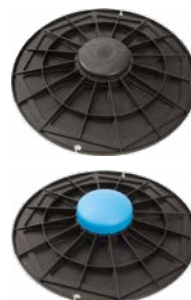

Category
D10

Ø42x58cm

> **Material:** Foam

Balance Pad

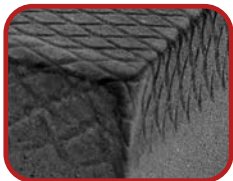

40×50×6cm

CODE	PRICE	COLOR
81765	\$ 15,50	
48195	\$ 15,50	

Category
D10

48045

\$ 5,10

> **Dimensions:** 18cm



+ Inflation valve
on the bottom

Stepping Stones



Std Pack
24

Category
D10

AMILA® BALANCE BALLS

Balance Balls are widely used in fitness, sports and rehabilitation, offering cardio, muscle strengthening, flexibility and endurance exercises. It will become your ally in improving your balance and posture.

High Quality

The base of the Ballance Balls is made of high quality plastic (PP), whereas the top part is made from PVC, offering maximum durability.

Anti-slip surface

The top part of the Ballance Balls has an anti-slip surface, due to their unique design.



95880

\$ 51,20

Balance Ball



SPECIFICATIONS

Dimensions: 60,0x60,0x23,0 cm

Endurance: 150 Kg

NET weight: 5,8 kg

Category: D10

95875

\$ 39,40

Balance Ball

Anti-slip 3mm high quality PVC



Anti-slip (PP) base



Tubes and pump included

SPECIFICATIONS

Dimensions: 60,0x60,0x23,0 cm

Endurance: 140 Kg

NET weight: 5,2 kg

Category: D10

CODE	PRICE	COLOR
48192	\$ 77,00	
48193	\$ 77,00	

Balance Ball

Anti-slip high quality PVC



Marine plywood base



Tubes and pump included

SPECIFICATIONS

Dimensions: 69,0x69,0x25,0 cm

Endurance: 300 Kg

NET weight: 7,3 kg

Category: D10

AMILA®

You Tube

Discover all of the **AMILA GymBall** exercises on our YouTube channel by scanning with your mobile the following qr-code.



DIAMETER	WEIGHT	COLOR	PACKAGING BOX WITH PUMP		PACKAGING BULK (NYLON BAG)	
			CODE	PRICE	CODE	PRICE
Ø55cm	1,00Kg		95826	\$ 8,20	48412	\$ 6,10
			95827	\$ 8,20	48438	\$ 6,10
			95828	\$ 8,20	48440	\$ 6,10
					48410	\$ 6,10
			95830	\$ 8,20	48409	\$ 6,10
			95831	\$ 8,20	48437	\$ 6,10
Ø65cm	1,35Kg		95845	\$ 9,04	48414	\$ 7,50
			95848	\$ 9,04	48439	\$ 7,50
			95846	\$ 9,04	48441	\$ 7,50
			95847	\$ 9,04	48413	\$ 7,50
Ø75cm	1,70Kg		95865	\$ 11,90	48417	\$ 10,25
			95866	\$ 11,90	48443	\$ 10,25
					48415	\$ 10,25
			95867	\$ 11,90	48425	\$ 10,25

AMILA®
GYM BALL
EXERCISE BALL
ANTI BURST

GymBall

- > **Material:** USA PVC (Higher Quality)
- > **Endurance:** 300Kg

Category D10

USA PVC

AMILA GymBalls are constructed from USA PVC, a high quality and very sturdy material, which offers excellent grip, so that you are always in full control of your exercises.



What is included in the box:

- Dual-action pump by AMILA
- Replacement plug for the air valve
- Sample exercises by Ifigenia Baka and Panagiotis Katsaounos, with video links of the recommended exercises



The **AMILA TwoTone GymBall** with reinforced base is one of the most flexible gym equipment. It offers a large variety of exercises for strengthening the upper part of the body, improving posture and flexibility.



The weight increases on the area of the double layer (dark colouring), forcing the ball to stabilise on it, continually using it as a base.

The reinforced lower side offers extra **grip** and prevents the rolling of the ball.

- > **Material:** PVC with reinforced base
- > **Endurance:** 300Kg
- > **Packaging:** Nylon bag

Two Tone Gym Balls

Returns to upright position

DIAMETER	WEIGHT	COLOR	CODE	PRICE
Ø65cm	1100gr		48445	\$ 9,70
			48446	\$ 9,70

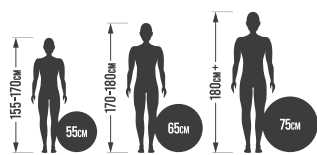

CHOOSE THE CORRECT SIZE

Gym balls are made in various sizes, using diverse materials. Using the right size for your body is essential for achieving the optimal results from your training.

You may derive the correct diameter for your body by sitting on the ball and your knees are at a 90 degree angle.

Tip: Your height is not the only factor for choosing a Gym Ball. The balls are flexible, so your weight is also quite important.



Category D10

- >> Hidden zipper
- >> Carrying handle

Gym Ball Covers



SPECS

Std Pack: 12
Category: D10

CODE	PRICE	MATERIAL	DIAMETER
96791	\$ 16,80	Sueded microfiber, brown color	65cm
96792	\$ 18,50	Sueded microfiber, brown color	75cm
96793	\$ 14,08	Linen based anti-dust material, grey color	65cm
96794	\$ 15,05	Linen based anti-dust material, grey color	75cm

Peanut Ball

ΣΥΣΚΕΥΑΣΙΑ ΣΑΚΟΥΛΑ (BULK)					
DIAMETER	LENGTH	WEIGHT	COLOR	CODE	PRICE
Ø45cm	85cm	1,45Kg		48095	\$ 7,70
				48097	\$ 7,70



Smart Exercising with a Game

The **AMILA Peanut Ball** has a wide range of benefits and can be a **fun** and very **engaging** way to cleverly introduce a game based therapy into the child's everyday life.

Peanut Shaped Gym Balls

- They only move in one direction, providing greater stability and control.
- They offer greater support to the spine and protect against minor injuries.
- They are ideal for rehabilitation and treatment, both for children and adults.

Peanut Balls are the tool of choice by thousands of physical therapists around the world.

They enhance the user's **balance** skills and ability to **focus**. It is excellent for **games and exercises** aimed at **tactile stimulation**.

Get the kids to use them at home instead of a regular chair, during homework or while watching TV.



Pregnancy Aid

The **AMILA Peanut Ball** is an important birthing aid (opening the pelvis) or epidural aid for use between the legs while resting on the bed.

However, the **unique advantages of a stable and controlled direction** make it ideal for practicing throughout pregnancy.



Scan the code and discover the first ever exercises for pregnant women by Ioanna Vaporidi (MSc Physical Education) and aquabirth.gr

Std Pack 8 Category D10

48071

\$ 8,00

- > **Diameter:** Ø50cm
- > **Material:** Vinyl
- > **Packaging:** Nylon bag



Jumping Ball with Handles

With two handles. For fun and people with movement disabilities.

Std Pack 25 Category D10

99350

\$ 10,35

- > **Diameter:** Ø45cm
- > **Material:** Vinyl
- > **Packaging:** Nylon bag



Jumping Ball with Handle

With "D" shaped handle. For fun and people with movement disabilities.

Std Pack 8 Category D10

PILATESBALL



Exercise book
The box includes an exercise book by Dimitra Akavalou



AMILA PilatesBalls are constructed from USA PVC, a high quality and very sturdy material, which offers excellent grip, so that you are always in full control of your exercises.



SPECIFICATIONS

Strength: 150Kg
Material: USA PVC (Higher Quality)
Category: D10

DIAMETER	WEIGHT	COLOR	PACKAGING BOX		PACKAGING BULK (NYLON BAG)	
			CODE	PRICE	CODE	PRICE
Ø19cm	150gr		95801	\$ 1,60	95804	\$ 1,10
					95808	\$ 1,10
			95803	\$ 1,60	95806	\$ 1,10
			95807	\$ 1,60	48430	\$ 1,10
					48433	\$ 1,10
			95802	\$ 1,60	95805	\$ 1,10
			48400	\$ 1,60	48432	\$ 1,10

DIAMETER	WEIGHT	COLOR	PACKAGING BOX		PACKAGING BULK (NYLON BAG)	
			CODE	PRICE	CODE	PRICE
Ø25cm	180gr		95815	\$ 1,90	95818	\$ 1,35
					95821	\$ 1,35
			95817	\$ 1,90	95820	\$ 1,35
					48431	\$ 1,35
			48401	\$ 1,90		
			95816	\$ 1,90	95819	\$ 1,35
			48434	\$ 1,90	48435	\$ 1,35

48073
\$ 1,95

SPECIFICATIONS

Diameter: 24,0cm
Material: USA PVC (Higher Quality)
Weight: 300 gr
Std Pack: 25
Category: D10

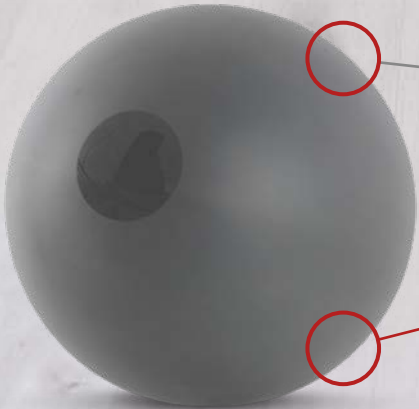

Construction

Made of thick PVC, very durable and less bouncy

Power Pilates Ball

Inflation

Inflate fully for more support and stability, or less to activate muscles you didn't even know existed!

The AMILA Pilates Ring activates and stimulates the muscular system in the torso, offering toning and strengthening of the muscles that form the core of the body (abdominal, back, buttocks).

It also improves posture, flexibility and spinal stability.

Pilates Ring Trinity

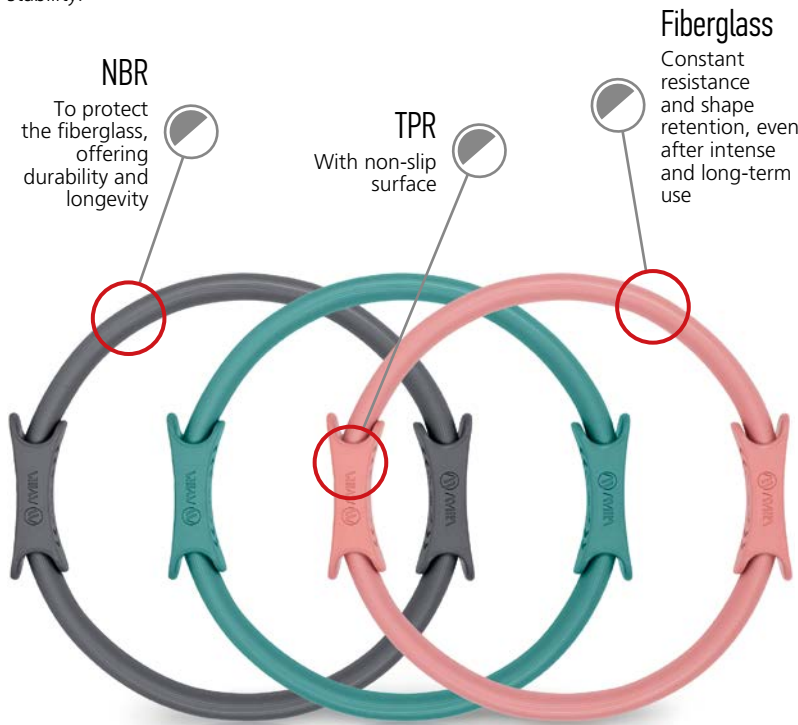

NBR

To protect the fiberglass, offering durability and longevity

TPR

With non-slip surface

Fiberglass

Constant resistance and shape retention, even after intense and long-term use

Combine them with

hip bands (p. 235), reformer towels (p. 219), foam rollers (p. 223) and socks (p. 204)

SPECIFICATIONS

Diameter: 35,5cm
Material: Ring: Fiberglass
Cover: NBR
Grips: TPR
Weight: 0.36kg
Std Pack: 10
Category: D10

CODE	PRICE	HARDNESS	COLOR
88155	\$ 6,10	Soft	
88156	\$ 6,10	Medium	
88157	\$ 6,10	Hard	

48082

\$ 7,40

> **Material:**
Fiberglass/ABS/PVC

Pilates Ring



• Personal use

Diameter	Weight	Std Pack	Category
36cm	0,7Kg	10	D10

nōra Pilates Ring

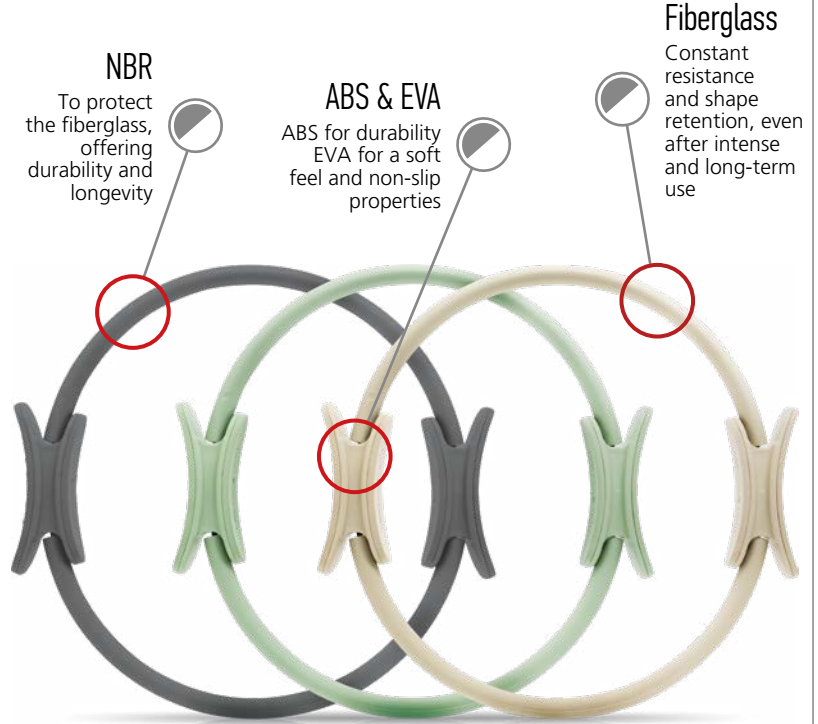

NBR

To protect the fiberglass, offering durability and longevity

ABS & EVA

ABS for durability
EVA for a soft feel and non-slip properties

Fiberglass

Constant resistance and shape retention, even after intense and long-term use

SPECIFICATIONS

Diameter: 36cm
Material: Ring: Fiberglass
Cover: NBR
Grips: ABS & EVA
Std Pack: 10
Κατηγορία: Δ10



CODE	PRICE	HARDNESS	WEIGHT	COLOR
99751	\$ 4,55	Light	270 gr	
99752	\$ 4,75	Medium	280 gr	
99753	\$ 4,95	Heavy	310 gr	

CODE	PRICE	HARDNESS	WEIGHT	COLOR
99754	\$ 4,55	Light	270 gr	
99755	\$ 4,75	Medium	280 gr	
99756	\$ 4,95	Heavy	310 gr	

CODE	PRICE	HARDNESS	WEIGHT	COLOR
99757	\$ 4,55	Light	270 gr	
99758	\$ 4,75	Medium	280 gr	
99759	\$ 4,95	Heavy	310 gr	

48090

\$ 6,95

- > **Material:** EVA
- > **Packaging:** Polybag

+ **Soft:** For beginners and those with trigger points they want to relax

This pistachio-shaped massage ball by AMILA is ergonomically designed to target all muscles which are difficult to reach with Foam Rollers, in order to help reduce the feeling of pain and provide faster muscle recovery.

Peanut Shaped Massage Ball



Weight 250gr Category D10

Ø8×16cm

- > **Material:** EVA
- > **Diameter:** 13cm
- > **Weight:** 280gr

Plexus Massage Ball



Std Pack 32 Category D10

CODE	PRICE	HARDNESS	COLOR
96781	\$ 5,00	Soft	
96782	\$ 6,40	Hard	

96959

\$ 4,90

- > **Material:** EVA + TPR

"Arch" Foot Massage Cylinder



Weight 180gr Category D10



Ø7,5×16cm

48091

\$ 1,55

- > **Material:** Hard PP
- > **Packaging:** Polybag

+ **Hard:** For the very fit and for muscle relaxation (trigger points)

Peanut Shaped Massage Ball



Weight 40gr Category D10

Ø8×16cm

44011

\$ 5,90

- > **Material:** Foam coated plastic
- > **Packaging:** Polybag

Thigh Exerciser



Std Pack 24 Category E6

81792

\$ 14,80

- > **Material:** ABS inner, TPE outer

- + Soft and non-slip outer surface due to TPE
- + Extremely durable inner due to ABS

Yoga Wheel



Category D10

Ø33cm

Palm Ball

CODE	PRICE	DIAMETER	WEIGHT	COLOR
96711	\$ 4,25	9,5 cm	0,50 Kg	Purple
96712	\$ 6,40		1,00 Kg	
96713	\$ 7,25		1,50 Kg	
96716	\$ 4,25		0,50 Kg	Blue
96717	\$ 6,40		1,00 Kg	
96718	\$ 7,25		1,50 Kg	
96721	\$ 4,25		0,50 Kg	Black
96722	\$ 6,40		1,00 Kg	
96723	\$ 7,25		1,50 Kg	

AMILA PalmBall weighted fitness balls are ideal for strength training, pilates, yoga, balance and rehabilitation exercises. They effectively tone your entire body, increase strength and improve balance and flexibility. They are made of durable, high-quality PVC, filled with iron sand, offering a stable grip and ease of use.

SPECS
 Material: PVC
 Pieces: 2
 Category: D10



- > **Material:** PVC
- > **Filling:** Sand
- > **Packaging:** Polybag

Gym Ball
Does not bounce



CODE	PRICE	WEIGHT	DIAMETER	COLOR
84710	\$ 3,65	4kg	Ø16,0cm	Red

Category D10

- > **Material:** Soft plastic
- > **Packing:** Polybag

Massage Balls



CODE	PRICE	DIAMETER	COLOR
48233	\$ 1,42	Ø8cm	Yellow
48234	\$ 1,22	Ø7cm	Green

Category D10

48236

\$ 2,38

Trigger Balls
Smaller size



Each color has a different hardness



SPECS

Pieces: 2
 Material: Silicone
 Diameter: 4,4cm
 Std Pack: 80
 Category: D10

48237

\$ 4,70

Massage Balls
Bigger size



Each color has a different hardness



SPECS

Pieces: 2
 Material: Silicone
 Diameter: 6,4cm
 Std Pack: 80
 Category: D10

81713

\$ 1,95

Safety Lock

» WARNING: You need 2 pcs for each swing



SPECS

Pieces: 1
 Certification: EN362
 Std Pack: 50
 Category: D10

95356

\$ 11,40

» WARNING: You need 2 pcs for each swing

Completely silent with full 360 degree rotation

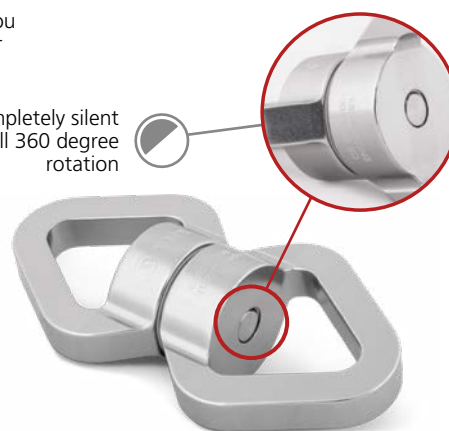

Yoga Swing Swivel



SPECS

Pieces: 1
 Material: Anodized powder coated aluminum
 Bearings: Steel, sealed in a chrome and carbon frame
 Strength: 3.000 kg
 Weight: 120 gr
 Certifications: CE0321/2008 and EN12275
 Std Pack: 50
 Category: D10

81712

\$ 5,80

Mount

» WARNING: You need 2 pcs for each swing



Swing for Aerial Yoga



81708

\$ 31,60

Swing for Anti-gravity Exercises



SPECS

Dimensions: 5 x 1,5m
 Elasticity: No
 Grips: 6
 Color: Blue
 Material: Nylon 210D
 Strength: 200kg
 Std Pack: 12
 Category: D10

CODE	PRICE	WIDTH	LENGTH	ELASTICITY	STRENGTH	MATERIAL	COLOR
96922	\$ 21,00	2,8m	5m	Small	260kg	Nylon 40D	
96923	\$ 21,00						
96924	\$ 21,00						
96925	\$ 21,00						
96926	\$ 21,00						
96927	\$ 21,00						
81709	\$ 37,90						6m
81702	\$ 37,90						
81710	\$ 43,30						

SPECS

Category: D10

81788

Extend Band

SPECS

Pieces: 2
 Length: 1,1 m
 Std Pack: 50
 Category: D10



Pulcherrima Pilates/Yoga Socks

Anti-slip dots on the bottom to increase grip



No seams on the fingers

SPECS

Pieces: Pair
 Five fingers: Yes, without seams
 Bottom grips: Silicone
 Material: Cotton 80%, Polyester 18%, Elastan 2%
 Std Pack: 100
 Category: D10

CODE	PRICE	SIZE	COLOR
99851	\$ 2,48	35-38	
99852	\$ 2,48	39-42	
99853	\$ 2,48	35-38	
99854	\$ 2,48	39-42	

Felis Pilates/Yoga Socks

Anti-slip dots on the bottom to increase grip



No seams on the fingers

SPECS

Pieces: Pair
 Five fingers: Yes, without seams
 Bottom grips: Silicone
 Material: Cotton 80%, Polyester 18%, Elastan 2%
 Std Pack: 100
 Category: D10

CODE	PRICE	SIZE	COLOR
99861	\$ 1,85	35-38	
99862	\$ 1,85	39-42	

Bellulu Pilates/Yoga Socks



Anti-slip dots on the bottom to increase grip

Combine them with

hip bands (p. 235), reformer towels (p. 219), foam rollers (p. 223) and pilates rings (p. 200)

SPECS

Pieces: Pair
 Five fingers: No
 Material: Cotton 80%, Polyester 18%, Elastan 2%
 Std Pack: 100
 Category: D10

CODE	PRICE	SIZE	COLOR
99857	\$ 1,95	35-38	
99858	\$ 1,95	39-42	
99855	\$ 1,95	35-38	
99856	\$ 1,95	39-42	
99859	\$ 1,95	35-38	
99860	\$ 1,95	39-42	
99863	\$ 1,95	35-38	
99864	\$ 1,95	39-42	

Balu Pilates/Yoga Socks

Anti-slip dots on the bottom to increase grip



SPECS

Pieces: Pair
 Five fingers: No
 Material: Cotton 80%, Polyester 18%, Elastan 2%
 Std Pack: 100
 Category: D10

CODE	PRICE	SIZE	COLOR
99865	\$ 2,10	35-38	
99866	\$ 2,10	39-42	

Felis High Pilates/Yoga Socks

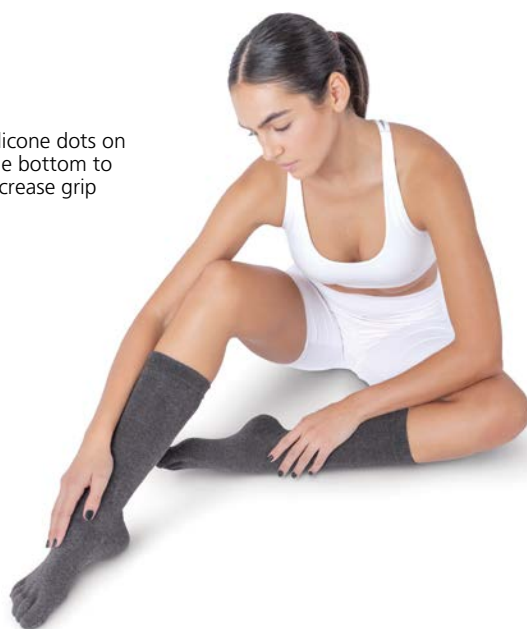

SPECS

Pieces: Pair
 Five fingers: Yes, without seams
 Bottom grips: Silicone
 Material: Cotton 80%,
 Polyester 18%, Elastan 2%
 Category: D10

CODE	PRICE	SIZE	COLOR
99871	\$ 3,50	35-38	
99872	\$ 3,50	39-42	



- » AMILA Training Socks offer added comfort to your workout with extra cushioning under the heel and forefoot, and a snug supportive arch band.
- » Sweat-wicking power and breathability up top help keep your feet dry and cool.

Performance
Training Socks

CODE	PRICE	SIZE	MATERIAL	CATEGORY	COLOR	STD PACK
99891	\$ 2,07	35-38	Nylon 100D	D10		48
99892	\$ 2,07	39-42				
99893	\$ 2,07	43-46				
99897	\$ 2,07	35-38				
99898	\$ 2,07	39-42				
99899	\$ 2,07	43-46				

- » AMILA Calf Compression Sleeves help increase blood flow to the muscles in order to work more efficiently. They dilate the arteries and allow you exercise longer, while at the same time reduce fatigue.
- » They are made of Polyamide, well known for its heat and moisture-wicking properties. The reflective surfaces allow vehicles to see you even at night.



Calf Sleeves

SPECS

Pieces: Pair
 Υλικό: 85% Polyamide, 15% Elastan
 Category: D10

CODE	PRICE	SIZE	COLOR
99881	\$ 3,95	S	
99882	\$ 3,95	M	
99883	\$ 3,95	L	

Measure your calf on its thickest part and the distance from the top of your foot up to just under the knee

	S	M	L
Calf Perimeter	30-34 cm	34-38 cm	38-42 cm
Height	25-35 cm	30-40 cm	35-45 cm



CORK YOGA

Yoga in a Natural Way

AMILA®



BEST
QUALITY
CORK

HIGH AESTHETICS
& DURABILITY
NATURAL PRODUCT

Nature's Way

This is not yet another Yoga series

The unique properties of the **AMILA Yoga Cork** series makes it a real aid, a training partner in your daily exercise group, superb aesthetics and durability, environmentally friendly. Do not choose your mat from the **AMILA Yoga Cork** series if the standards you have set do not require **the absolute best for you.**

ENVIRONMENTALLY FRIENDLY

Cork is a **100% biodegradable material.** It does not create waste, nor does it destroy nature. It exploits only the fully regeneratable bark of the tree.

NATURAL - ANTIMICROBIAL MATERIAL

Even during extremely demanding workouts, during which more sweat is produced, the **AMILA Yoga Cork** series, in contrast to the usual/simple/plastic materials, remains **clean, without the production of unpleasant odors** (see cleaning instructions). You will never see mold.

NON-TOXIC

The **AMILA Yoga Cork** series is **100% free from chemicals** found in conventional fitness aids.

DURATION

Due to its composition, cork is very **resistant to abrasion and compression.** It is **highly elastic,** having an increased lifespan, without being strained from the daily use during the exercises. It is also **resistant to oils, grease, and salt water** (sweat), which makes it suitable for fitness use.

ANTI-SLIP PROPERTIES

Cork absorbs moisture, thus being the perfect material for your workouts. This very ability **increases traction.**

INSULATING PROPERTIES

Cork is a poor conductor of heat. This property of it **offers absolute neutrality,** both in Hot Yoga and in the contrasts of the weather. Thus, a warm environment doesn't heat up the mattress, so it doesn't make you uncomfortable, and vice versa.

CARE

Daily cleaning is not required; however, cleaning after excessive sweating (possibly after a hot yoga class) is recommended.

Cleaning Instructions



1 Spread a non-toxic cleaner on the surface of the cork.



2 Scrub the stains with a toothbrush or a soft brush.



3 Wipe with a lightly damp towel.



4 Let it dry in a dry and cool place, without exposure to weather extremes, cork side up.

48084

\$ 4,60

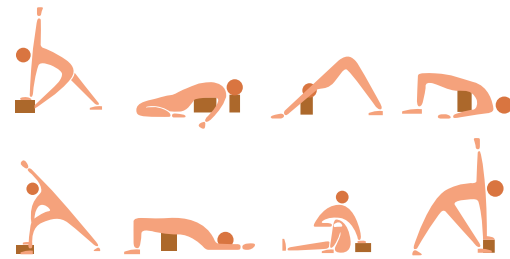

Cork Yoga Brick



SPECS

Material: Cork 100%
 Weight: 750 gr
 Dimensions: 7,6x15x23 cm
 Std Pack: 20
 Category: D10

96805

\$ 11,30

Cork Roller



SPECS

Material: Cork 100%
 Weight: 800 gr
 Dimensions: Ø100x30 cm
 Std Pack: 12
 Category: D10

96809

\$ 6,10

Cork Peanut Ball



SPECS

Material: Cork 100%
 Weight: 120 gr
 Dimensions: Ø8x16 cm
 Std Pack: 24
 Category: D10



Cork Yoga Mat



SPECS

Material: TPE and Cork
 Cork thickness: 0,2mm
 Std Pack: 12
 Category: D10

CODE	PRICE	WEIGHT	DIMENSIONS
96811	\$ 12,00	650gr/m ²	173x61cm x 4mm
96812	\$ 14,60	950gr/m ²	173x61cm x 6mm

47503

\$ 104,10

Gym Mat

With reinforced corners

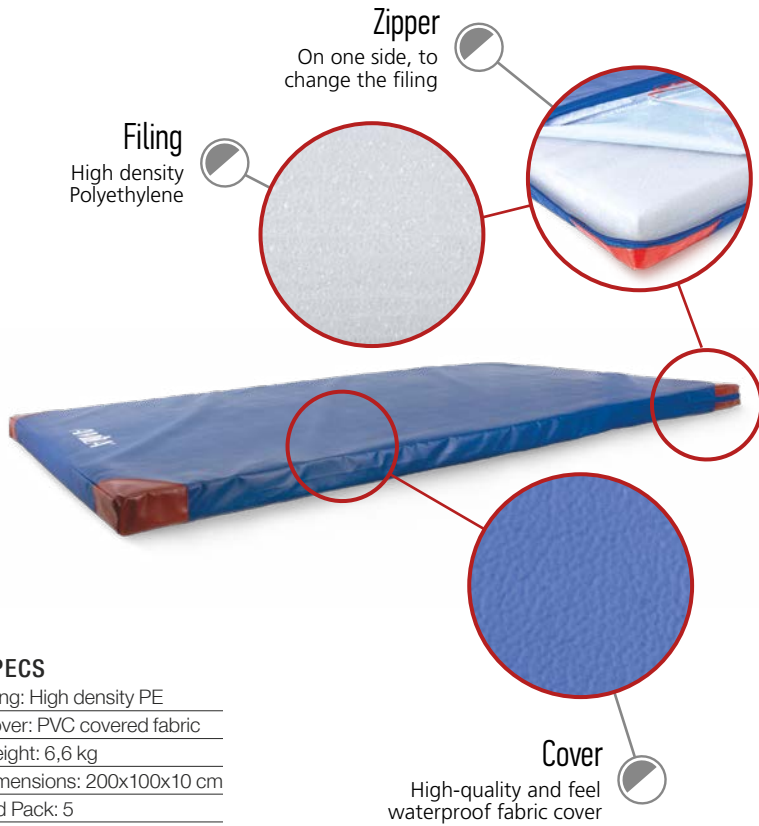

SPECS

Filing: High density PE
 Cover: PVC covered fabric
 Weight: 6,6 kg
 Dimensions: 200x100x10 cm
 Std Pack: 5
 Category: D10

47500

\$ 85,40

Gym Mat

With reinforced corners



SPECS

Filing: High density PE
 Cover: Water resistant Nylon 600D
 Weight: 3,0 kg
 Dimensions: 200x120x7 cm
 Std Pack: 5
 Category: D10

Gym Mat

With reinforced corners

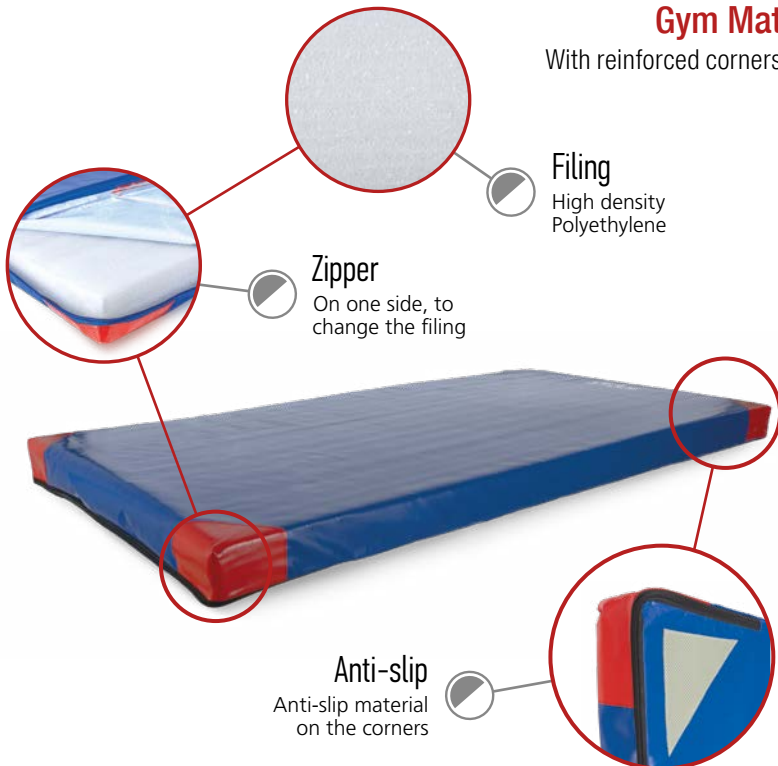

SPECS

Filing: High density PE
 Cover: Tear resistant 550 gr/m² fabric
 Std Pack: 1
 Category: D10

CODE	PRICE	DIMENSIONS	WEIGHT
47504	\$ 87,40	200x100x10 cm	6,9 kg
47505	\$ 62,70	200x100x6 cm	5,15 kg

47502

\$ 90,90

Gym Mat

4ply folding



SPECS

Filing: High density PE
 Κάλυμμα: Υφασμα με επικάλυψη PVC
 Weight: 8,6 kg
 Dimensions: 240x120x5 cm
 Std Pack: 1
 Category: D10



47501

\$ 64,20

Gym Mat

Filing
High density
Polyethylene

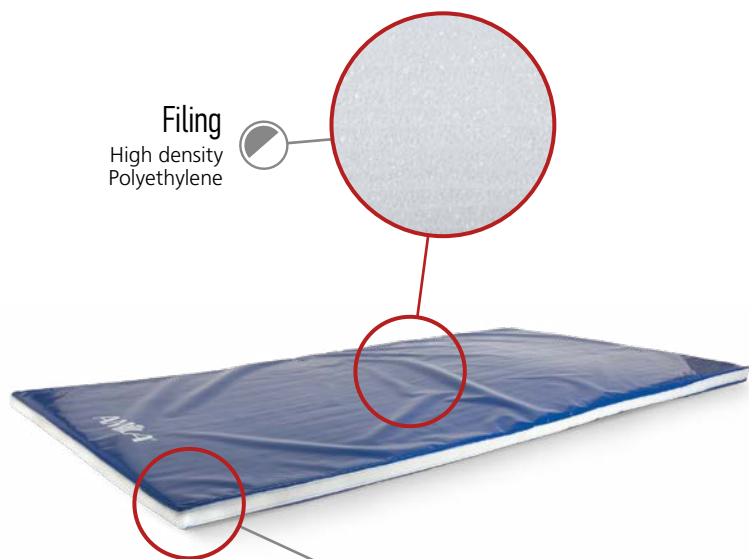

Zipper
On one side, to
change the filing

SPECS

Filing: High density PE
Cover: Water resistant Nylon 600D
Weight: 4,0 kg
Dimensions: 200x100x4 cm
Std Pack: 10
Category: D10

47507

\$ 76,50

Gym Mat

2ply folding

Velcro

All around Velcro
to join many mats



Filing
High density
Polyethylene

SPECS

Filing: High density PE
Cover: Nylon
Weight: 6,7 kg
Dimensions: 200x100x6 cm
Std Pack: 1
Category: D10



44208

\$ 24,80

Exercise Mat

4ply folding

- » Maximum protection for floor exercises
- » Adequate protection for falls



SPECS

Filing: Foam
Weight: 2,9 kg
Dimensions: 180x60x4 cm
Std Pack: 5
Category: D10



- » Simple/Economical mat for floor exercises
- » It can not be used for Yoga exercises since it does not allow the skin to breathe

Exercise Mat



SPECS

Filing: PE
Weight: 0,4 kg
Dimensions: 180x60x2,5 cm
Std Pack: 5
Category: D10

CODE	PRICE	COLOR
44206	\$ 10,50	
44209	\$ 10,50	

Στρώματα

Η πιο μεγάλη σύγχυση όταν ξεκινά να κάνει κάποιος **yoga ή pilates** βρίσκεται στο στρώμα που πρέπει να επιλεγεί. Τα στρώματα pilates είναι παρόμοια με τα στρώματα ασκήσεων που συνήθως υπάρχουν στα γυμναστήρια ενώ τα στρώματα yoga διαφέρουν, όχι όμως τόσο πολύ και στην εμφάνιση, με αποτέλεσμα να μεπερδεύουν στην διαδικασία επιλογής. **Τα χαρακτηριστικά τους είναι αυτά που τα κάνουν κατάλληλα για τη μια ή την άλλη μορφή.** Υπάρχουν σημαντικές διαφορές.

Κατηγορίες στρωμάτων Yoga, Pilates και Ασκήσεων Εδάφους

- Από **PVC**. Συνιστώνται για Yoga.
- Από **TPE**. Συνιστώνται για Yoga, χρησιμοποιούνται και για Pilates.
- Από **NBR**. Συνιστώνται για Pilates και Ασκήσεις Εδάφους.
- Από **EVA**. Συνιστώνται για Ασκήσεις Εδάφους, χρησιμοποιούνται και για Pilates.

Το πιο διαδεδομένο υλικό στα στρώμα. Διατίθεται κυρίως σε δυο πάχ (4mm και 6mm) και σε διάφορες ποιότητες, ανάλογα με το **πυκνότητα** (βάρος σε kg/m3), και την **προσθήκη υλικών** που αυξάνουν την αντοχή του στις καταπονήσεις και την εντριβή.

1 Στρώματα PVC

- + Ικανοποιητική αντοχή στην συμπίεση και τις καταπονήσεις.
- + Ικανοποιητική αντιολίσθηση.
- + Ανταγωνιστική τιμή.
- + Ελαφρύ, ευκολία κατά τη μεταφορά.
- Περιβαλλοντολογική επιβάρυνση.
- Μέτριες επιδόσεις.
- Μη φιλική αίσθηση.
- Δεν συνίσταται στα άτομα που παρουσιάζουν αλλεργίες στο PVC.

Μέγιστη
Αντιολισθητικότητα



Πάχος
Στρωμάτων
TPE

- 6mm
- 8mm
- 10mm



2 Στρώματα TPE

Τα **οικολογικά στρώματα** (φιλικά προς το περιβάλλον) είναι κατασκευασμένα από αφρώδη, μη τοξικά, βιοδιασπώμενα ελαστομερή θερμο-πλαστικά (TPE). Τα στρώματα αυτά δεν είναι απλώς οικολογικά και **βιοδιασπώμενα** αλλά και **δίχως latex και PVC**.

- + Αρίστη αντοχή στην συμπίεση η οποία, σε συνδυασμό με τα μεγάλα πάχη, προσφέρει κορυφαία προστασία.
- + Αρίστη σχηματική επαναφορά μετά την συμπίεση (memory foam).
- + Αντιολισθητικότητα, λόγω του υλικού (λάστιχο) και του τρόπου κατασκευής.
- Υψηλό κόστος που το καθιστά επιλογή κυρίως για όσους ασχολούνται εντατικά με το pilates και σε υψηλό επίπεδο (μπορούν να εκτελέσει τις πιο δύσκολες ασκήσεις).

Το στρώμα αποτελείται από δυο υποστρώματα. Στη μέση υπάρχει πλέγμα.

AMILA

Προτεινόμενες
Χρήσεις
των Στρωμάτων

Τι είναι το Pilates

Πέρα από μία μέθοδος γυμναστικής είναι μία **πλήρης μελέτη του ανθρώπινου σώματος**. Η μέθοδος αυτή αναπτύχθηκε στην Αμερική από τον J. H. Pilates που συνδύασε τις βασικές αρχές της yoga και άλλων παραδοσιακών μεθόδων που προέρχονται από ανατολικές φιλοσοφίες με στοιχεία μεταγενέστερων δυτικών μεθόδων.

Οφέλη του Pilates

- Βελτίωση της δύναμης, της ευελιξίας και της ισορροπίας.
- Τόνωση και μυϊκή ενδυνάμωση χωρίς όγκο.
- Δυνατό κοιλιακό.
- Αποκατάσταση της σωστής στάσης και ευθυγράμμισης του σώματος.
- Δημιουργία μιας ισχυρότερης, πιο εύκαμπτης σπονδυλικής στήλης.
- Ενίσχυση της κινητικότητας, της ευκινησίας και της δύναμης.

Τι είναι η Yoga

Η yoga πάνω απ' όλα είναι ένας **τρόπος ζωής**. Ένα ολοκληρωμένο επιστημονικό σύστημα, το οποίο συνδυάζει με απόλυτη αρμονία της άσκησης, όχι μόνο του σώματος αλλά και του νου.

Οφέλη της "Yoga"

- Αύξηση μυοσκελετικής ευλιγισίας και των κινήσεων στις αρθρώσεις.
- Βελτιωμένη στάση του σώματος και της σπονδυλικής στήλης.
- Βελτίωση λειτουργίας αναπνευστικού συστήματος.
- Περισσότερη αντοχή και μυϊκή δύναμη.
- Μείωση ή απαλλαγή από διάφορους σωματικούς πόνους, όπως της μέσης του αυχένα, των καρπών κλπ.
- Βελτίωση της λειτουργίας της καρδιάς. Μείωση της αρτηριακής πίεσης.
- Εύκολος και πιο ξεκούραστος ύπνος.

Στρώματα NBR 3

Τα στρώματα NBR είναι **κατασκευασμένα από ένα είδος φυσικού καουτσούκ που μοιάζει με latex**. Συνήθως είναι παχύτερα των 8mm, έτσι τα NBR στρώματα μπορούν να χρησιμοποιηθούν ακόμα και για ασκήσεις εδάφους.

Το ποσοστό του φυσικού καουτσούκ σε συνδυασμό με την πυκνότητα του υλικού (μέτρηση σε Kg/m³) είναι τα στοιχεία που καθορίζουν την ποιότητα του στρώματος. Η ποσότητα του καουτσούκ (λόγο της διαφοράς κόστους με το PVC) προσδιορίζει και την τιμή του προϊόντος. Όσο περισσότερο τόσο ακριβότερο.

- + Ελαφρύ, σπογγώδες στρώμα.
- + Πολύ καλή προστασία σε όλα τα πάχη η οποία γίνεται εξαιρετική όταν η ποσότητα του φυσικού καουτσούκ είναι μεγάλη ή η πυκνότητα του υλικού ξεπερνά τα 90-110Kg/m³.
- + Αριστη αντοχή στην συμπίεση και άμεση επαναφορά. Ειδικότερα στα στρώματα με μεγάλο ποσοστό φυσικού καουτσούκ.
- + Ευκολία κατά τη μεταφορά, παρότι διαθέτει μεγαλύτερο όγκο από τα στρώματα PVC και TPE/TPU.
- Υψηλό κόστος.
- Ογκωδέστερο των στρωμάτων PVC και TPE/TPU.
- Ευπαθή σε καταπονήσεις και αιχμές. Δεν συνιστάται για επαγγελματική χρήση.



Η εξαιρετική αντοχή των στρωμάτων **EVA** σε συνδυασμό με τον υψηλό δείκτη προστασίας που προσφέρουν, τα καθιστά **ιδανικά για χρήση από γυμναστήρια**.

Διαφορές TPE/TPU και PVC

- Το TPU είναι πιο δυνατό και πιο ανθεκτικό υλικό από το PVC.
- Το TPU είναι άοσμο (φιλικό προς το περιβάλλον) ενώ το PVC μυρίζει, ιδίως σε περιβάλλον με υψηλή θερμοκρασία (ζέ- στη, καλοκαίρι κ.λπ.).
- Το TPU είναι υλικό υψηλής καθαρότητας έχοντας μεγάλη αντίσταση στην οξειδωση, ενώ το PVC είναι ένα μίγμα υλικών. Έτσι, με το πέρασμα του χρόνου, το TPU διατηρείται καθαρό ενώ το PVC κηλιδώνεται και θαμπώνει.

Η "Yoga", επειδή έχει κυρίως ασκήσεις αναπνοής και ευελιξίας δεν έχει μεγάλες απαιτήσεις από τα στρώματα.

- Η Yoga αυξάνει το εύρος της κίνησης σας, την αίσθηση της ευημερίας και μπορεί να μειώσει την πίεση. Το Pilates ενισχύει τον "πυρήνα" σας (π.χ. τους κοιλιακούς, τον κορμό, την κατώτερη σπονδυλική στήλη) και βοηθά να αναπτύξετε τους αδύναμους μύες.
 - Η Yoga βοηθά να μάθετε να ελέγχετε την αναπνοή σας. Το Pilates βοηθά να μάθετε να ελέγχετε καλύτερα τη στάση σας.
 - Η Yoga είναι γνωστή για την ανάπτυξη δύναμης, σταθερότητας και ισορροπίας. Το Pilates είναι γνωστό για τη δημιουργία μήκους στο σώμα και για το ότι προσφέρει ασφάλεια και έλεγχο.
- Στην Yoga η εισπνοή και η εκπνοή είναι από τη μύτη. Στο Pilates η εισπνοή είναι από τη μύτη και η εκπνοή από το στόμα.
- Η Yoga εστιάζει περισσότερο σε αναπνευστικές ασκήσεις ώστε να "διευρύνει" το σώμα μέσα και έξω. Αποκτάει κανείς συντομότερα καλύτερη φυσική κατάσταση, διότι έχει πιο δυναμικό πρόγραμμα. Η μέθοδος Pilates είναι ένα πρόγραμμα πιο στατικό το οποίο γυμνάζει εξίσου όλο το σώμα, αλλά απαιτείται λιγότερη προσπάθεια.

Τα **EVA** υψηλής πυκνότητας είναι η τελευταία εξέλιξη στην αγορά των στρωμάτων και **στοχεύουν κυρίως σε αυτούς που εκτελούν ασκήσεις εδάφους**.

4 Στρώματα EVA

- + Υψηλής πυκνότητας υλικό που προσφέρει κορυφαία προστασία.
- + Εξαιρετική αντοχή στον χρόνο, ιδανικό για επαγγελματική χρήση.
- + Αίσθηση.
- + Μικρό βάρος.
- Υψηλό κόστος το οποίο όμως αποσβένετε γρήγορα.
- Δυσκολία κατά τη μεταφορά. Συνιστάτε η χρήση από γυμναστήρια.

Yoga VS Pilates

Yoga Mat

» **Caution:** PVC mats are not suitable for commercial use and, under certain conditions and floor texture, can be slippery

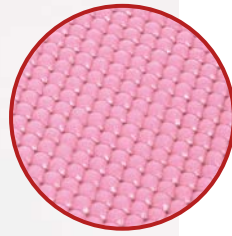

Embossed surface



SPECS
Material: PVC
Category: D10



CODE	PRICE	WEIGHT	DIMENSIONS	COLOR
96751	\$ 4,90	860gr/m ²	173x61cm x 4mm	Grey
96752	\$ 4,90			Olive
81715	\$ 4,90			Purple
81721	\$ 4,90			Pink
81705	\$ 4,90			Blue
81704	\$ 4,90			Black
96753	\$ 7,10	1100gr/m ²	173x61cm x 6mm	Grey
96754	\$ 7,10			Olive
81703	\$ 7,10			Black
81707	\$ 7,10			Purple
81706	\$ 7,10			Pink
81716	\$ 7,10			Blue

81727

\$ 1,15

Mat Bag

- » High durability due to the materials used
- » Do not lose their grip even after a long time
- » Very pleasant texture, extremely comfortable
- » Ecological



SPECS
Dimensions: 69x14 cm
Category: D10

Yoga Mat

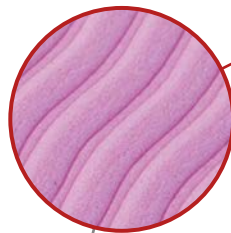

Mesh embedded between the two layers, increasing their anti-skid properties



SPECS
Material: TPE
Category: D10

CODE	PRICE	MESH	DIMENSIONS	COLOR
81772	\$ 11,35	Yes	173x60cm x 8mm	Black
81778	\$ 10,90	Yes	173x60cm x 6mm	Blue

81777

\$ 14,00

> **Material:** **TPE** on the bottom for support and cushioning, **RUBBER** on the top for traction and durability

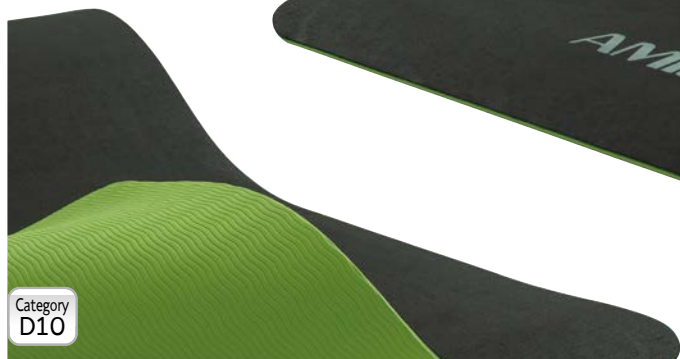

Category D10



Yoga Mat



150x61cm x 8mm

81779

\$ 12,80

> **Material:** **TPE** on the bottom for support and cushioning, **SUEDE** on the top for traction and luxurious feel



Category D10

Yoga Mat

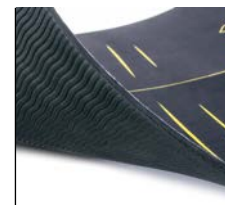

173x60cm x 6mm

> **Material:** **Natural rubber** on the bottom for optimum anti-slip performance, **PU** on the top for great feel and protection from sweat

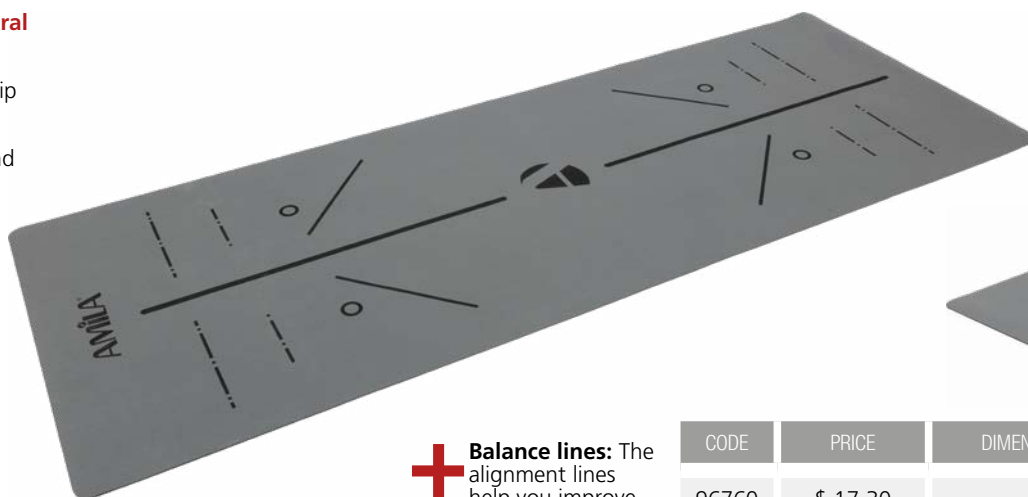

Yoga Mat



+ Balance lines: The alignment lines help you improve your workout. They are not printed on the mat, so there is no fear of them fading over time.

SPECS

Material: Natural Rubber and PU

Std Pack: 4

Category: D10

CODE	PRICE	DIMENSIONS	COLOR
96760	\$ 17,30	183x66cm x 4mm	Grey
96761	\$ 17,30		Red
96762	\$ 17,30		Teal

> Material: NBR 70kg/m³

Enormous Exercise Mat

- The only one with a width of 80cm



- No more being afraid of "falling off" your mat when exercising

CODE	PRICE	STORAGE	DIMENSIONS
81774	\$ 11,35	Belt	1800x800x10mm

Std Pack 6 Category D10

> Material: TPE/EVA in 25-75% percentage, top EVA 90kg/m³ to be strong enough for use and bottom TPE to be anti-skid

Exercise Mat

- The 2 materials are bonded together by the heat of the hydraulic press
- Easy to clean since it does not absorb water/sweat



- Long lasting and durable
- Honeycomb texture on one side

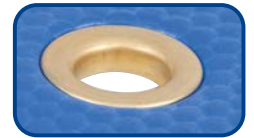

CODE	PRICE	STORAGE	DIMENSIONS
81764	\$ 15,00	Eyebolts	1200x600x16mm

Category F1

> Material: NBR, a new foam material offering high protection and increased comfort



Pilates Mats

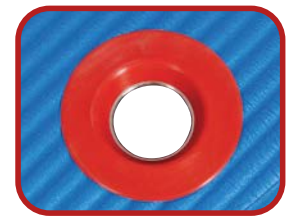

Std Pack 10 Category F1

Weight of the material

- > **80 kg/m³**: The most common quality
- > **90 kg/m³**: Gym quality. Bigger protection and service life, but also weighs more and is more expensive
- > **100 kg/m³**: The highest quality. Offers superb protection, the thickness needs not exceed 12mm, offering protection equivalent of mats 15mm thick with a weight of 90kg/m³, with the convenience of a smaller volume

NBR (Nitrile Butadiene Rubber)

Since 2012, NBR is the industry standard and the preferred material for gym mats because of its high protection and comfort level it offers when compared to other materials, also because of the ease when storing and transporting. Its quality mainly depends on two factors:

1. The knowledge, experience and processing of the factory, time spent processing and foaming process.
2. Also on the the density, which is expressed by the weight of the material per cubic meter.

The weight affects the density, which has a direct relationship with the comfort it offers. Durability: under no circumstances does this material have the durability of EVA; this is the reason gyms have began using EVA mats in our days.



Length of mat

- > **140cm**: Recommended for aerobics
- > **180cm**: Ideal for Pilates



CODE	PRICE	WEIGHT	DIMENSIONS	STORAGE	COLOR
81730	\$ 10,05	80Kg	183x60cm x 15mm	Belt	Grey
81776	\$ 10,05				Black
95911	\$ 12,50				Dark Grey
95910	\$ 12,50	90Kg	142x60cm x 12mm	Belt	Black
95904	\$ 9,55				Dark Grey
95905	\$ 9,55				Blue
81782	\$ 9,55	100Kg	183x60cm x 15mm	Eyebolts	Black
95901	\$ 5,85				Black

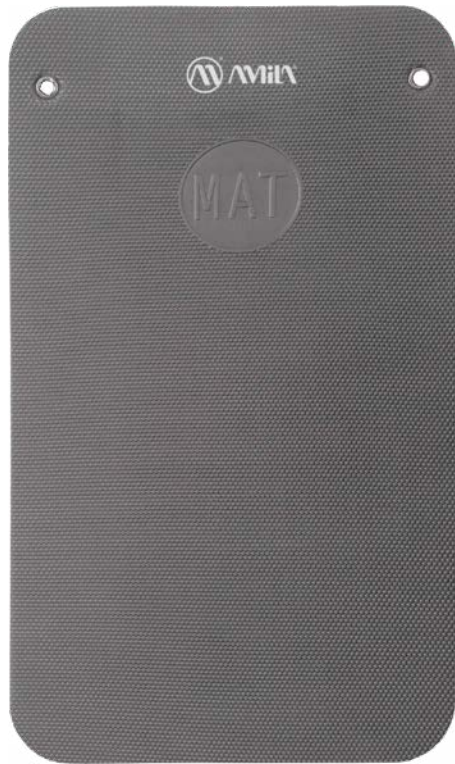

Pilates Mat
 > **Material:** EVA

Προσφέρει **εξαιρετική προστασία και μεγάλη αντοχή**. Το πλέον κατάλληλο για επαγγελματική χρήση σε γυμναστήριο.

Πλεονεκτήματα και Μειονεκτήματα Στρωμάτων EVA

- + Υψηλής πυκνότητας υλικό που προσφέρει κορυφαία προστασία.
- + Εξαιρετική αντοχή στο χρόνο, ιδανικό για επαγγελματική χρήση.
- + Αίσθηση.
- + Μικρό βάρος.
- Υψηλό κόστος, το οποίο όμως αποσβένεται γρήγορα.
- Δυσκολία κατά τη μεταφορά, συνίσταται χρήση σε γυμναστήρια.



SCAN HERE 
 Promo video on our YouTube channel.

CODE	PRICE	STORAGE	DIMENSIONS	COLOR
81735	\$ 13,90	Eyebolts	140x60cm x 15mm	
81744	\$ 13,90			
81745	\$ 13,90			
81766	\$ 13,90			
81750	\$ 12,95		120x60cm x 16mm	
81752	\$ 12,20			
81753	\$ 12,20			
81740	\$ 10,90			
81729	\$ 10,90		100x60cm x 15mm	
81749	\$ 10,90			

Category
F1

Yoga Brick and Belt

Ideal for use during exercises involving **lifting** or **lowering** in all possible positions. It helps to **stabilise** and adds height for better **balance** or is placed between the knees in order to **activate** the inner leg muscles.

AMILA
Yoga Block
The best way to do Yoga

Made from high-quality non-toxic foam

Special design, without edges, for added comfort and ease of use

Extremely durable

Improve your flexibility and balance

Securely place your body in the correct position



Yoga Block

Ideal for Yoga and special exercises

CODE	PRICE	COLOR	
48083	\$ 2,08		<ul style="list-style-type: none"> > Material: EVA > Weight: 140gr > Dimensions: 23×14,5×7,5cm > Packaging: Gelatin with paper hanging ribbon
96840	\$ 2,08		
96841	\$ 2,08		
96842	\$ 2,08		
96843	\$ 2,08		
96844	\$ 2,08		

PCS 1
Category D10



Yoga Belt

Ideal for Yoga exercises

48087

\$ 2,42

- > **Material:** Cotton
- > **Width:** 4cm
- > **Length:** 195cm
- > **Packaging:** Nylon bag

The belt **helps making exercising easier**. It is particularly useful for those starting Yoga and want to have less pressure.

Feeling tight? The belt can **help you progress to more difficult asanas** to gain flexibility faster.

It is **the oldest** and **most basic Yoga accessory** that can be used as an exercising aid.

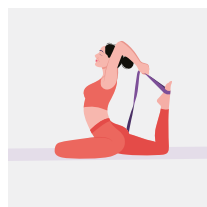

Std Pack 100
Category D10

96904

\$ 3,59

Gym Towel

Soft 380 gsm cotton, effectively absorbs sweat, offering a soft and pleasant feel

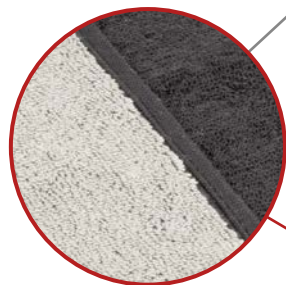

Practical loop with clasp to hang it and always keep it close to you

SPECIFICATIONS

Dimensions: 100x50 cm

Material: Soft 380gsm cotton

Std Pack: 50

Category: D10

Machine washable and quick drying, always clean and ready for use.

96907

\$ 8,50

Lewot Plus

Gym towel

- > **Material:** 96% super-soft 550gsm cotton, 4% polyester
- > **Zipper:** YKK
- > **Dimensions:** 118x43cm

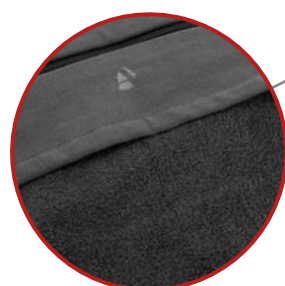

Stitched pocket on the back to safely attach to the top of exercise benches



Zippered accessory pouch

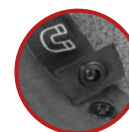

With removable magnet to easily fasten to Racks etc.

Category D10

- > **Material:** Cotton (Code #96835 from organic cotton)
- > **Width:** 3,8cm
- > **Length:** 240cm

Yoga Belt

Ideal for Yoga exercises



Code 96835
Made of 100% Organic Cotton

100% Organic Cotton

CODE	PRICE	COLOR
96831	\$ 2,12	Charcoal
96832	\$ 2,12	Mint
96833	\$ 2,12	Natural
96834	\$ 2,12	Purple
96835	\$ 3,55	Organic Natural*

PCS 1

Category D10



PILATES

Reformer Non-Slip Towel



AMILA®
TOWEL

Specially designed to fit perfectly on Reformer Beds

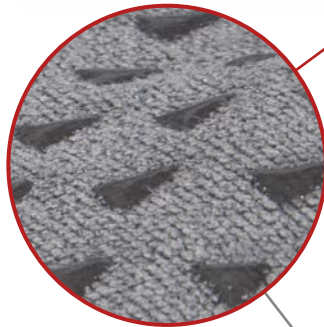

Anti-slip silicone triangles on the back side for added safety while exercising



2 Special covers for the Pilates bed (included with code 96905)



Carrying bag of the same fabric as the towel

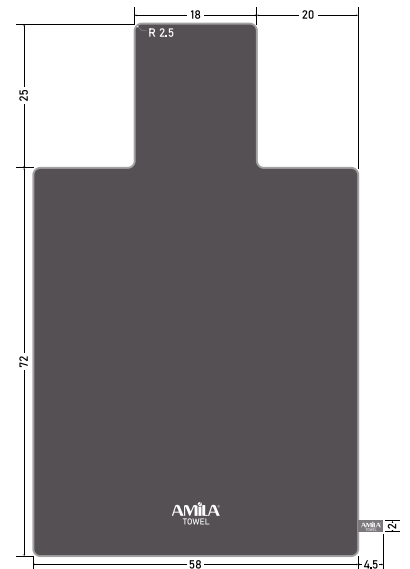

96905

\$ 10,60

Reformer Towel Pro

» You can use your own logo (printed or stitched)

SPECIFICATIONS

Dimensions: 97,0x58,0 cm

Material: Fancy

Weight: 300gsm

Logo: Stitched

Std Pack: 50

Category: D10



Three different colors to choose from



Trinity Reformer Towels

Material

Soft microfiber 200gsm suede, effectively absorbs sweat and offers a soft, pleasant feeling on the skin throughout your workout

Non-slip

The underside features silicone anti-slip triangles, specially designed for high grip. The towel stays in place, no matter how many poses you change.

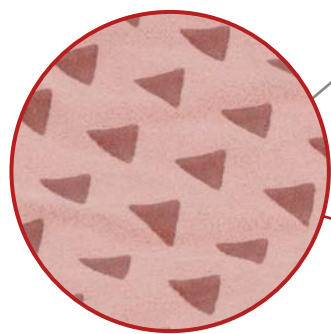

Combine them with

hip bands (p. 235), foam rollers (p. 223), pilates rings (p. 200) and socks (p. 204)

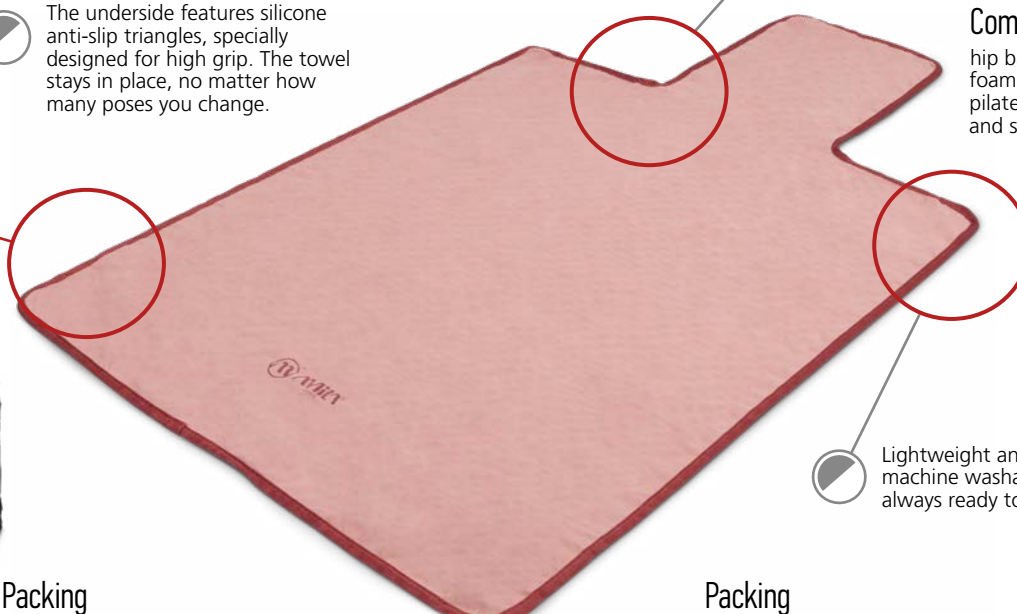

Lightweight and easy to fold, machine washable and quick drying, always ready to be used.

Packing

In a round carton, accompanied by a carrying case



Packing

Bulk (plastic bag), for studios/gyms

SPECIFICATIONS

Dimensions: 96,0x58,0 cm
Material: Sueded Microfiber
Weight: 200gsm
Logo: Printed
Std Pack: 50
Category: D10

CODE	PRICE	COLOR	STD PACK	CATEGORY
96903	\$ 5,92			
96910	\$ 5,92	Teal	50	D10
96911	\$ 5,92	Pink		

CODE	PRICE	COLOR	STD PACK	CATEGORY
96912	\$ 4,52			
96913	\$ 4,52	Teal	50	D10
96914	\$ 4,52	Pink		

Cooling in 3 Steps

CoolTowel stays cool for up to 2 hours, while you continue your activity without interruption.



Step 1: Wet the towel using lots of clean water



Step 2: Wring it to remove unnecessary water



Step 3: Shake vigorously 2-3 times to activate the cooling effect

SPECIFICATIONS

Dimensions: 100x50 cm
Material: 50% Polyester, 50% Polyamid



Case

The perforated silicone case protects and the towel and keeps it well ventilated

- » Wash at a temperature of 30°C after use. Does not need ironing.
- » Provides immediate relief from (sports) injuries, on the neck and joint pain.
- » Prevents sunstroke and cools your head when you have a fever, headache or sunburn.

Material

The highly absorbent fibers absorb the sweat and immediately cool the skin

Cool Towel

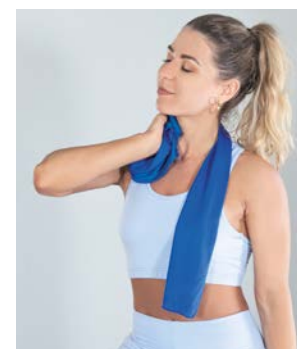

CODE	PRICE	COLOR	STD PACK	CATEGORY
96908	\$ 4,34	Green		
96909	\$ 4,34	Blue	50	D10

44084

\$ 7,85

- Non-slip lower side

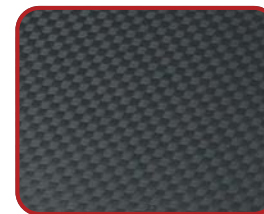

- Woven heavy duty vinyl

AB Cushion

Category
F1

84627

\$ 8,30

- > Improved quality with better and thicker foam for added protection



- + Better finishing

AB Cushion

Category
F1

30,5×36,5cm

81798

\$ 56,90

Useful for stretching and correcting your bones and skeleton and bring them back to correct positions

- > **Dimensions:** 59x25x3~11cm
- > **Material:** Internal: Cold Memory Foam, density 80kg/m³ with excellent air permeability, providing the right amount of softness
External: Breathable/washable fabric with antimicrobial lining
- > **Range:** Upward/downward 4cm



Removable, washable, breathable external fabric, with antimicrobial lining



Easy to adjust height with the turn of a knob

Adjustable Yoga Cushion

Weight 1.9Kg Std Pack 5 Category D10

**AMILA
Foam Rollers**

The perfect tool to increase blood circulation and toning strained muscles. It prepares the muscles for the exercise that will follow, or any kind of activity.



Follow us on social media and be the first to learn about what is new in fitness



AMILA®

Prevents Injuries
Rehabilitation
Recovery
Warm-up
Improves Flexibility



Exercise book in packaging



QUADRICEPS



LATISSIMUS DORSI



ILIOTIBIAL BAND



GROIN



HIPS



BACK/WAIST

Reasons to use AMILA Foam Rollers:

Performance Enhancement: A strained muscle can limit you and reduce your performance. When you use the AMILA Foam Rollers, you can bring your muscles back to normal, increasing your range of motion. This way you can achieve a better performance, as the muscles (which will have recovered) will be able to be fully used.

Fast Recovery: Exercising with the Foam Roller helps the muscle recover.
Relieves Pain: When you use MFR (Myofascial Release, Self-myofascial Release) methods on the active/afflicted parts of your muscles that trigger pain, you increase blood circulation to the muscles and connective tissues. The better the circulation, the more oxygen gets through, meaning your muscle can recover faster or even hurt less.

- > **Material:** EPP
- > **Packaging:** Nylon bag

Soma



Expanded Polypropylene (EPP)

Expanded Polypropylene (EPP) is a flexible cellular foam offering energy absorption and extremely high ration of endurance compared to weight. It is 100% recyclable and can be produced in a wide range of densities. It is inherently harder than EVA and PU.

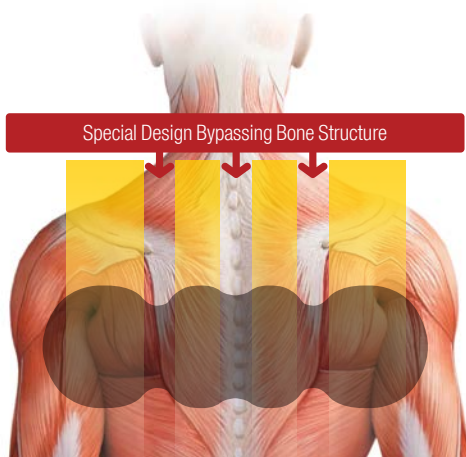

DIAMETER	LENGTH	WEIGHT	HARDNESS	COLOR	CODE	PRICE
Ø15cm	45cm	260gr	●○○		96801	\$ 5,50
			●●○		96802	\$ 7,40
			●●●		96803	\$ 6,00

Std Pack 10 Category D10

- > **Material:** EPP
- > **Roughness:** Smooth
- > **Packaging:** Nylon bag

Foam Roller EPP Pro



Embossed logo

Expanded Polypropylene (EPP)

Expanded Polypropylene (EPP) is a flexible cellular foam offering energy absorption and extremely high ration of endurance compared to weight. It is 100% recyclable and can be produced in a wide range of densities. It is inherently harder than EVA and PU.

DIAMETER	LENGTH	WEIGHT	HARDNESS	COLOR	CODE	PRICE
Ø15cm	90cm	450gr	●○○		96820	\$ 7,14
			●●●		96825	\$ 10,25

Std Pack 10 Category D10

- > **Material:** EPP
- > **Roughness:** Smooth
- > **Packaging:** Nylon bag

Half Foam Roller EPP Pro

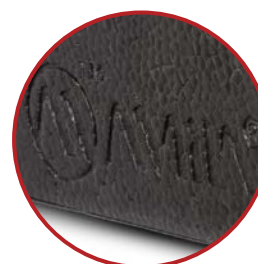

Embossed logo

Expanded Polypropylene (EPP)

Expanded Polypropylene (EPP) is a flexible cellular foam offering energy absorption and extremely high ration of endurance compared to weight. It is 100% recyclable and can be produced in a wide range of densities. It is inherently harder than EVA and PU.

> **Height:** 7,5 cm

DIAMETER	LENGTH	WEIGHT	HARDNESS	COLOR	CODE	PRICE
Ø15cm	90cm	225gr	●●●		96830	\$ 4,48

Std Pack 20 Category D10

- > **Material:** PU
- > **Tube:** ABS
- > **Packaging:** Nylon bag

Purse



Special for small items internal storage space (towel, bands, keys etc.), securing with a lid.

- + Made of injection-moulded PU
- + Doesn't have the "stretch marks" of heat treatment
- + **Triple service life**

Std Pack 10 Category D10

DIAMETER	LENGTH	WEIGHT	HARDNESS	COLOR	CODE	PRICE
Ø13cm	42,5cm	1000gr	●●●		81791	\$ 13,30

- > **Material:** EVA
- > **Roughness:** Medium
- > **Packaging:** Nylon bag

Foam Roller Pro



DIAMETER	LENGTH	WEIGHT	HARDNESS	COLOR	CODE	PRICE
Ø15cm	90cm	730gr	●●●	Blue	48069	\$ 15,50
	90cm	730gr		Black	96823	\$ 15,50
	60cm	500gr	●●●	Black	96838	\$ 10,20
	30cm	260gr	Blue	48068	\$ 6,10	
				Black	96824	\$ 6,10

Std Pack 12 Std Pack 20 Category D10



Combine them with hip bands (p. 235), reformer towels (p. 234), pilates rings (p. 200) and socks (p. 204)

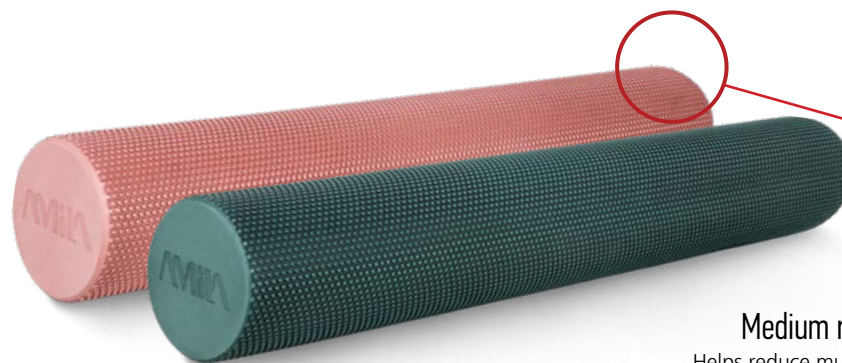

Trinity Foam Roller

Medium roughness
Helps reduce muscle tension and relieve trigger points

SPECS

Material: EVA
Roughness: Medium
Packaging: Nylon bag
Std Pack: 10
Category: D10

DIAMETER	LENGTH	WEIGHT	HARDNESS	COLOR	CODE	PRICE
Ø15cm	90cm	730gr	●●●	Red	96836	\$ 15,50
				Green	96837	\$ 15,50

- > **Material:** EPP
- > **Roughness:** Rough
- > **Packaging:** Nylon bag

Spike



Button-shaped logo

Expanded Polypropylene (EPP)
Expanded Polypropylene (EPP) is a flexible cellular foam offering energy absorption and extremely high ration of endurance compared to weight. It is 100% recyclable and can be produced in a wide range of densities. It is inherently harder than EVA and PU.

Std Pack 20
Category D10

DIAMETER	LENGTH	WEIGHT	HARDNESS	COLOR	CODE	PRICE
Ø14cm	32cm	130gr	●●●		96818	\$ 3,85

- > **Material:** EVA
- > **Tube:** ABS
- > **Packaging:** Nylon bag

Plexus 33



DIAMETER	LENGTH	WEIGHT	HARDNESS	COLOR	CODE	PRICE
Ø14cm	33cm	700gr	●●●		96806	\$ 5,50
					96821	\$ 5,50
					96822	\$ 5,50

- > **Material:** EVA
- > **Tube:** ABS
- > **Packaging:** Nylon bag

Plexus 45
Foam Roller



DIAMETER	LENGTH	WEIGHT	HARDNESS	COLOR	CODE	PRICE
Ø14cm	45cm	1200gr	●●●		96827	\$ 8,25

Std Pack 10
Category D10



Arrow 33
Foam Roller



SPECS

Material: EVA
 Tube: ABS
 Packaging: Shrink-wrap
 Category: D10

DIAMETER	LENGTH	WEIGHT	HARDNESS	COLOR	CODE	PRICE
Ø14cm	33cm	700gr	●●●		96828	\$ 5,70

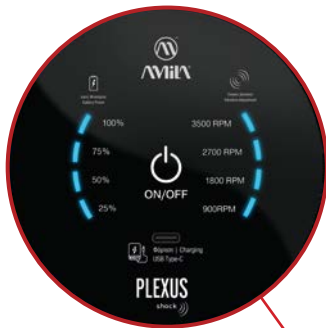

PLEXUS Shock
Rechargeable eFoam Roller



SPECIFICATIONS

Material: EVA
 Tube: ABS
 Packaging: Paper box
 Charging: USB Type-C
 Vibration: Adjustable, 4 levels
 Std Pack: 4
 Category: D10

- Battery charge indicator
- Vibration: Adjustable frequency (900, 1.800, 2.700 and 3.500 vibrations per minute)

DIAMETER	LENGTH	WEIGHT	HARDNESS	COLOR	CODE	PRICE
Ø14cm	33cm	2.000gr	●●○		96829	\$ 37,80



Τα λάστιχα αλλά και οι ιμάντες είναι κατασκευασμένοι από **φυσικό Latex**. Η καλύτερη ποιότητα φυσικού Latex, είναι το Καουτσούκ που βγαίνει από τα δένδρα της Μαλαισίας (rubber tree). Τα χαρακτηριστικά του φυσικού Latex **που συναντάμε συνήθως στην αγορά** είναι:

- + Μεγάλη επιμήκυνση (μέχρι και 5 φορές).
- + Διάρκεια ζωής (αυξημένη 10-20% περισσότερο από τα Latex free).
- Όχι απόλυτη γραμμικότητα της αντίστασης.
- Το γαλακτώδες υγρό του φυσικού λάστιχου δημιουργεί αλλεργίες εξ αίτια των πρωτεϊνών που περιέχονται σε αυτό.
- Χρειάζεται να πουδραρισθεί για να μην έχει την αίσθηση της κόλλας.

Πόσο καιρό μπορεί να χρησιμοποιείτε μια ζώνη αντίστασης;

Οι ζώνες αντίστασης της **Sanctband** είναι **κατασκευασμένες από υψηλής ποιότητας καουτσούκ**, όμως δεν παύει να είναι ένα ελαστικό. Αν προσεχθεί (δεν χρησιμοποιηθεί σε τραχείς επιφάνειες, δεν τεντώσει πάνω από το μέγιστο μήκος, δεν εκτίθεται στον ήλιο κ.λπ.) η ζωή **μπορεί να διαρκέσει από 3 μήνες έως και 1 χρόνο**, υπό κανονικές συνθήκες (οικιακής χρήσης/άτομο).

Χαρακτηριστικά Sanctband



Χωρίς Πούδρα: Τα προϊόντα της Sanctband έχουν εξαλείψει την ανάγκη για χρήση πούδρας.



Χαμηλή Πρωτεΐνη: Ελαχιστοποίηση των αλλεργικών παθήσεων με την απομάκρυνση των πρωτεϊνών από το γαλακτώδες καουτσούκ.



Διάρκεια Ζωής: Υλικά ανθεκτικά στις επαναλήψεις που βελτιώνουν 10% της διάρκειας ζωής του ελαστικού.



Αποτελεσματικότητα: Εξασφαλίζουν την γραμμικότητα της αντίστασης κατά την επιμήκυνση του ελαστικού.



Ασφάλεια: Διατηρούν τις ιδιότητές τους -δίχως θραύση- ακόμα και με 500% επιμήκυνση.



Φιλικά στο Περιβάλλον: Τα προϊόντα της Sanctband κατασκευάζονται με μεθόδους φιλικούς στο περιβάλλον, από καθαρή ενέργεια, μικρής κατανάλωσης και μειωμένου όγκου αποβλήτων.

Επιμήκυνση

Επιμήκυνση από 100% σε 200% υποδηλώνει την αντίσταση που παρέχετε από το ελαστικό όταν τεντώνει από 2 σε 3 φορές περισσότερο (έχει γίνει διπλάσιο ή τριπλάσιο) του αρχικού του μεγέθους.

Για παράδειγμα, αν μια ζώνη αντίστασης έχει μήκος 1 μέτρο, όταν επεκταθεί στα 2 μέτρα τότε το έχετε κάνει διπλάσιο (100% πάνω) του κανονικού μήκους ηρεμίας.

Σημείωση: Η δύναμη αντίστασης εφαρμόζεται σε οποιοδήποτε μήκος της ζώνης και αν τεντωθεί, **όχι μόνο σε ολόκληρο το μήκος**. Εάν δηλαδή ένα τμήμα 40cm τεντωθεί έως το 1,2m, τότε έχει γίνει τριπλάσιο (τεντώθηκε 200%) του μήκους ηρεμίας του.

Sanctband

"**Λάστιχα/Ελαστικά Αντίστασης**", "**Σωλήνες Αντίστασης**" ή "**Ζώνες Αντίστασης**" είναι ένας γενικός όρος για κάθε ελαστικό σωλήνα ή ζώνη (μπάντα, λεπτή ταινία) που χρησιμοποιείτε για τις ασκήσεις ενδυνάμωσης (π.χ. ασκήσεις αντίστασης), δηλαδή τις ασκήσεις που εφαρμόζεται στο σώμα μια δύναμη αντίστασης η οποία είναι μεγαλύτερη από την κανονική.

Αυτή η δύναμη μπορεί να παρέχεται κάνοντας χρήση μηχανημάτων, αλτήρων και άλλων παρεμφερή βαρών (kettlebells κ.α.) ή **ελαστικών αντίστασης**.

Το σώμα δεν μπορεί να καταλάβει διαφορές στις ασκήσεις ενδυνάμωσης που γίνονται κάνοντας χρήση οργάνων, μεταλλικών βαρών ή ελαστικών αντίστασης. Οι μύες θα εξακολουθούν να δυναμώνουν σε όλες τις περιπτώσεις.

Η **Sanctband** είναι Μαλαισιανή εταιρεία και έχει στην ιδιοκτησία της ένα από τα τρία (3) εργοστάσια στην Μαλαισία που παράγουν λάστιχα και ιμάντες από **φυσικό Μαλαισιανό Latex**.

Έχει αναπτύξει δικές της μεθόδους παραγωγής που **επιλύουν τα αρνητικά σημεία του φυσικού Latex** και **βελτιώνουν την απόδοση**.

Γιατί θα πρέπει να δοκιμάσετε τα "exercise band" της Sanctband;

- **Φορπτότητα - ευκολία στην μετακίνηση** Ο εξαιρετικά μικρός τους όγκος, σε συνδυασμό με το ελάχιστο βάρος τους, καθιστά την μεταφορά εφικτή από οποιαδήποτε αποσκευή, ακόμα και μέσω της τσάντας που χρησιμοποιούμε στην καθημερινότητά μας.
- **Ομαλότητα** Η προοδευτική γραμμική αύξηση της αντίστασης κατά την ένταση των ασκήσεων προσφέρει ομαλότητα στο σώμα, ειδικότερα στις αρθρώσεις.
- **Αύξηση της ισορροπίας και της ικανότητας συντονισμού του σώματος** Επειδή υπάρχει αρκετή ένταση κατά τη διάρκεια των ασκήσεων, το σώμα πρέπει να είναι σταθεροποιημένο. Η εκτέλεση ασκήσεων με λάστιχα γυμναστικής απαιτεί υψηλές ικανότητες συντονισμού (με την άσκηση και την ισορροπία του σώματος), κάτι που επί τις ουσίας γυμνάζει επιπλέον μύες και **είναι πολύ διασκεδαστικό!**
- **Ποικιλία** Η δυνατότητα να **μεταβάλλεται συνεχώς η ένταση** για να γίνει η εκγύμναση περισσότερο ή λιγότερο δυναμική **δίχως παύσεις** σε συνδυασμό με την **εκτέλεση πολύπλοκων ασκήσεων**, που δεν μπορούν να γίνουν εύκολα (ή και καθόλου) με χρήση μηχανών ή ελεύθερων βαρών, κάνει τα exercise bands τη μοναδική λύση για αυτές τις απαιτήσεις.
- **Κόστος** Κανένας άλλος εξοπλισμός για ασκήσεις ενδυνάμωσης δεν προσφέρετε σε ελκυστικότερες τιμές. Ακόμα και αν επιλεγούν 2, 3 ή και 4 λάστιχα με διαφορετικά επίπεδα αντίστασης, το συνολικό κόστος είναι πολύ μικρότερο από οποιονδήποτε άλλο προϊόν.
- **Ιδανικά για όλα τα επίπεδα φυσικής κατάστασης** Ο τρόπος που χρησιμοποιούνται τα καθιστά ιδανικά τόσο σε αρχάριους όσο και σε προχωρημένους. Μπορούν να χρησιμοποιηθούν από βασικές κινήσεις μέχρι την προσθήκη έντασης σε εξειδικευμένες ασκήσεις.

Tip * 1N = 0,102gr

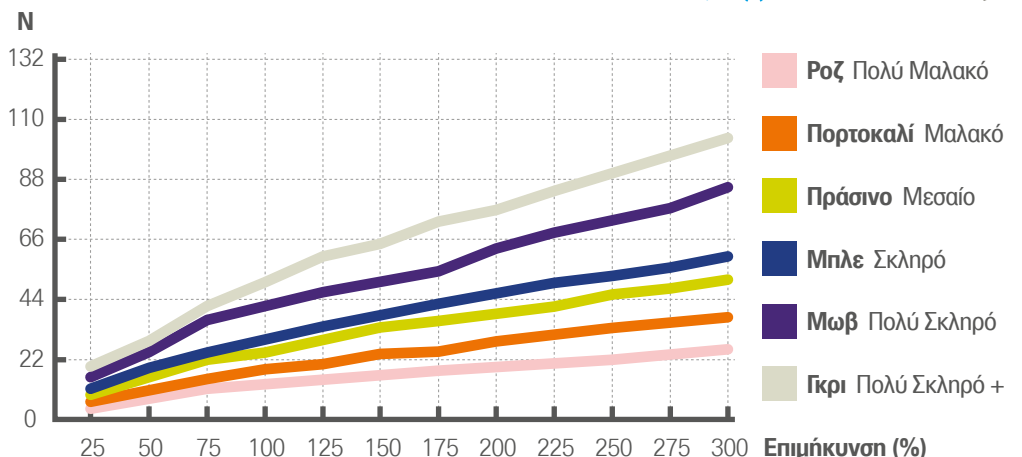



Sanctband™ Tubing With Handles

Better in Everyway



> Length: 120cm

- With door anchor included

CODE	PRICE	THICKNESS	HARDNESS	COLOR	RESISTANCE
					200%
88220	\$ 3,90	1,4mm	Very Soft		2,5Kg
88221	\$ 4,20	1,7mm	Soft		2,5Kg
88222	\$ 4,40	2,0mm	Medium		4,0Kg
88223	\$ 4,60	2,3mm	Hard		5,0Kg
88224	\$ 4,80	2,6mm	Very Hard		5,5Kg

Category D10

Sanctband™ Active Tubing With Handles

Better in Everyway

> Length: 150cm

- With door anchor included



CODE	PRICE	THICKNESS	HARDNESS	COLOR	RESISTANCE
					200%
88265	\$ 5,35	1,7mm	Soft		3,5Kg
88266	\$ 5,20	2,0mm	Medium		4,0Kg
88267	\$ 5,80	2,3mm	Hard		5,0Kg
88268	\$ 6,00	2,6mm	Very Hard		5,5Kg
88269	\$ 6,30	2,9mm	Very Hard +		6,5Kg

Category D10



Sanctband™ Restrictive Band

Better in Everyway

> Length: 2,0m x 15cm • With door anchor included

Category D10

CODE	PRICE	THICKNESS	HARDNESS	COLOR	RESISTANCE
					200%
88304	\$ 3,35	0,40mm	Very Hard		4,3Kg
88305	\$ 3,70	0,45mm	Very Hard +		5,1Kg



> Length: 1,5m x 15,0cm

Category D10

CODE	PRICE	THICKNESS	HARDNESS	COLOR	RESISTANCE
					200%
88201	\$ 1,10	0,20mm	Soft		2,1Kg



Sanctband™ Loop Band
Better in Everyway

> Length: 33cm
> Width: 5cm

CODE	PRICE	THICKNESS	HARDNESS	COLOR	RESISTANCE
					200%
88231	\$ 2,10	0,50mm	Soft		3,8Kg
88232	\$ 2,28	0,70mm	Medium		5,3Kg

Category D10

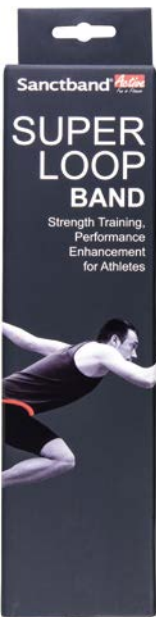

Sanctband™ Active Super Loop Band
Better in Everyway

> Length: 104cm
> Thickness: 4,8mm

CODE	PRICE	WIDTH	HARDNESS	COLOR	RESISTANCE
					200%
88276	\$ 11,70	3,49cm	Hard +		19,90Kg
88278	\$ 15,65	5,72cm	Very Hard +		32,00Kg
88279	\$ 17,70	6,35cm	Very Hard ++		33,80Kg

Category D10

- > **Material:** 100% natural latex
- > **Length:** 208cm
- > **Width:** 5cm



Floss Band

- > **Benefits:** The Floss Band is an essential performance tool and should be a staple in the gym bag of every athlete looking to improve range, restore joint mechanics, or unglue matted down or previously injured tissue. Compression tack and flossing works on many levels; including re-perfusing tissues that have become stiff or gone cold after injury, and by compressing swelling out of tissues and joints.
- > **Thickness:** Thicker band provides more compression and is better suited in difficult areas like the high hips. This band is also great for larger athletes like powerlifters and strongmen when more compression is needed.



CODE	PRICE	THICKNESS
96950	\$ 4,09	1,00mm
96952	\$ 5,70	1,50mm

Category D10



Sanctband™ Comprefloss Floss Band
Better in Everyway

> Length: 200cm
> Width: 5cm

CODE	PRICE	THICKNESS	HARDNESS	COLOR
88281	\$ 5,95	1,10mm	Soft	
88282	\$ 7,00	1,30mm	Medium	
88283	\$ 8,05	1,60mm	Hard	
88284	\$ 8,90	1,80mm	Very Hard	

Category D10

Fabric Hip Band

- > **Material:** Nylon/Latex
- > **Perimeter:** 68,6cm
- > **Thickness:** 2,2mm





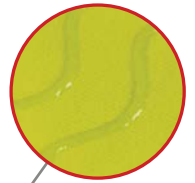

Std Pack 100
Category D10



Inner wavy silicon anti-slip lines



SCAN HERE 
and watch exercise videos on our YouTube channel.

CODE	PRICE	COLOR	HARDNESS	WIDTH	RESISTANCE
96620	\$ 2,80		Light	6cm	12,70Kg
96621	\$ 3,40		Medium	7cm	17,25Kg
96622	\$ 3,90		Heavy	8cm	21,80Kg

Multi Loop Resistance Band

- > **Material:** Nylon/Polyester/Latex
- > **Length:** 112cm



SCAN HERE and watch exercise videos on our YouTube channel.



CODE	PRICE	COLOR	HARDNESS	WIDTH	RESISTANCE
96623	\$ 3,10		Light	5cm	6 Kg
96624	\$ 3,45		Medium		8 Kg
96625	\$ 3,90		Heavy		10 Kg

Std Pack **72** Category **D10**

88186

\$ 8,90

"D" Rings for easy adjustment and change of resistance



Tubes with Sleeves for maximum durability

Straps with reinforced neoprene lining and strong velcro

Std Pack **30** Category **D10**

Abductor Set

If your choice of training your abductors is nothing short of the best, then the **AMILA** abductor set is the way to go. The kit includes **2 x Straps**, with **reinforced neoprene lining for maximum protection and ease**, **2 x Tubes with Sleeves** (medium resistance) and

1 x Transport/Storage Pouch.

The adjustable straps allow you to loosen or tighten the cuffs using the strong velcro and attach the tubes to the "D" type rings. Easy to wear and adjust to the desired fit; compatible with typical resistance systems with clips.



88186006

\$ 4,65

- > **Strap Width:** 6,5cm
- > **Ring:** "D" type
- > **Packaging:** Nylon bag

Abductor Straps

for Abductor Tubes with reinforced neoprene lining and strong velcro

Reinforced Neoprene
Reinforced neoprene lining for the absolute feeling of safety and comfort



- > **Length:** 35cm
- > **End:** Clip
- > **Packaging:** Nylon bag

Abductor Tubes

for Abductor Straps with clips and sleeves

Color Coded
Easily choose the right resistance

Reinforced Finish
Protects the links to prevent damage and corrosion

Sleeves
Special protection of the tubes for maximum durability



CODE	PRICE	COLOR	RESISTANCE
88186001	\$ 3,70		● ○ ○
88186002	\$ 3,80		● ● ○
88186003	\$ 3,90		● ● ●

PCS **2** Std Pack **30** Category **D10**

AMILA®

Physical Condition | Rehabilitation | Strengthening

GYMTUBE

Work-out with
Christina
Pantazopoulou

All **AMILA GymTubes with grip** packages (Foam Grip and Gorilla Grip) include a leaflet (with accompanying video links) with training suggestions of the Physical Education and Sports Professor (Athens TEFAA) **Christina Pantazopoulou**.



Double-Dipped Latex Tubing

AMILA GymTubes are double-dipped in Latex and are an excellent choice for fitness professionals. They are designed to offer unsurpassed performance and maximum durability.



GymTubes Resistance Chart

The **linear resistance** is the most important quality criterion for a tube.

AMILA GymTubes are the professional's basic training and recovery option.

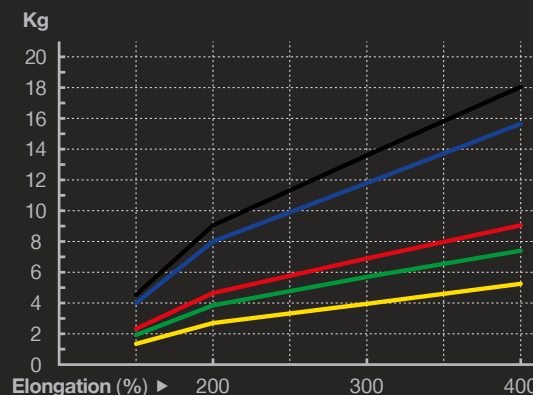

COLOR	HARDNESS	THICKNESS	RESISTANCE		
			200%	300%	400%
Yellow	Ultra Light	1,5mm	2,70Kg	3,25Kg	5,25Kg
Green	Light	2,0mm	3,85Kg	6,60Kg	7,40Kg
Red	Medium	2,5mm	4,65Kg	7,75Kg	9,05Kg
Blue	Heavy	3,0mm	8,00Kg	10,60Kg	15,65Kg
Black	Ultimate	3,5mm	9,05Kg	13,50Kg	18,05Kg



In collaboration with the **School of Health & Welfare Scientists**, for the program "Education and Therapeutic Exercise with the Application of the Clinical Pilates method" of the **Lifelong Learning Center** of the **University of West Attica**, ELDICO is in constant contact, making **AMILA** products available for the needs of the conducted programs and laboratory measurements, receiving important information on the development of the provided aids.



> **Packaging:**
New hangable box
Contains exercise leaflet

AMILA GorillaGrip

Gorilla Grip
Rubber grip made with custom mold



> **Length:** 140cm
> **Grip:** GorillaGrip
> **Grip (diameter):** 3,5cm
> **Grip (width):** 13cm
> **Strap (width):** 3,8cm

Gym Tube wGorillaGrip

CODE	PRICE	COLOR	HARDNESS
96651	\$ 4,60		Ultra Light
96652	\$ 5,10		Light
96653	\$ 5,45		Medium
96654	\$ 5,65		Heavy
96655	\$ 6,60		Ultimate

Category D10



> **Packaging:**
New hangable box
Contains exercise leaflet

Foam Grip
Foam vinyl grip for comfort and to avoid sweating



> **Length:** 140cm
> **Grip:** Foam
> **Grip (diameter):** 3,0cm
> **Grip (width):** 12cm
> **Strap (width):** 2,9cm

Gym Tube wFoamGrip

CODE	PRICE	COLOR	HARDNESS
48125	\$ 4,35		Ultra Light
48126	\$ 4,50		Light
48127	\$ 4,65		Medium
48128	\$ 5,00		Heavy
48129	\$ 5,48		Ultimate

Category D10

Multi Power Clip System

AMILA's Multi Power Clip System enables combined use with many tubes of the same or different resistance, which can be adjusted to different anchoring points, both on the body (see the pages with the accessories for bands with clips) as well as on a fixed point (base).



> **Packaging:**
New nylon bag with head-card

Reinforced Finish
Protects the links to prevent damage and corrosion

Sleeve
Protection of the tube for maximum durability

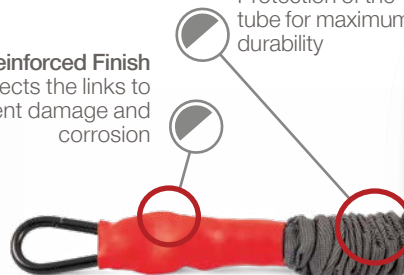

> **Length:** 140cm
> **Point:** Clip

Gym Tube wClip&Sleeve

CODE	PRICE	COLOR	HARDNESS
88165	\$ 5,10		Ultra Light
88166	\$ 5,20		Light
88167	\$ 5,40		Medium
88168	\$ 6,00		Heavy
88169	\$ 7,16		Ultimate

Category D10

Multi Power Clip System

AMILA's Multi Power Clip System enables combined use with many tubes of the same or different resistance, which can be adjusted to different anchoring points, both on the body (see the pages with the accessories for bands with clips) as well as on a fixed point (base).



> **Packaging:**
New nylon bag with head-card

Reinforced Clip
Improved clip for increased resistance to strain



> **Length:** 140cm
> **Point:** Clip

Gym Tube wClip

CODE	PRICE	COLOR	HARDNESS
88160	\$ 3,35		Ultra Light
88161	\$ 3,60		Light
88162	\$ 4,05		Medium
88163	\$ 4,55		Heavy
88164	\$ 5,63		Ultimate

Category D10

- > Length: 25m
- > Inner Diameter: 6mm
- > Packaging: Box



Gym Tube Roll

- > Length: 110cm
- > Inner Diameter: 6mm
- > Packaging: Hangable blister



"8" Shaped Tube

CODE	PRICE	COLOR	HARDNESS	DIAMETER
48171	\$ 27,65	■	Medium	10mm
48172	\$ 35,20	■	Ultimate	11mm
48173	\$ 43,50	■	Ultimate+	12mm

Std Pack 10 Category D10

Std Pack 40 Category D10

CODE	PRICE	COLOR	HARDNESS	THICKNESS
48152	\$ 3,30	■	Ultimate	12mm



- > Strap Width: 5cm
- > Ring: "D" shaped
- > Packaging: Nylon bag

Leg Training Set
With 3 levels of resistance

Smart Kit containing 2 x Ankle Straps with 3 x Resistance Tubes with Clips that can work in tandem increasing or decreasing the resistance level according to your needs. Lightweight and compact, ideal for workouts at home and while traveling.

Std Pack 50 Category D10

CODE	PRICE	COLOR	HARDNESS	RESISTANCE
				200%
88175	\$ 5,15	■	Medium	4,5Kg
88176	\$ 5,35	■	Heavy	6,5Kg
88178	\$ 5,80	■	Ultimate	8,5Kg
88179	\$ 6,35	■	Ultimate+	10,5Kg



Build-In Construction
Two built-in comfortable, and adjustable ankle cuffs with velcro straps that stay in place whatever the exercise

- > Strap Width: 5cm
- > Packaging: Hangable nylon bag with hang-tag

Ankle Tube

Lightweight and compact, ideal for workouts at home and while traveling. Tones and strengthens hips and thighs through a complete range of movements. Its design allows for forward, backward, sideways and diagonal movement for functional fitness and balance.

Std Pack 50 Category D10

CODE	PRICE	COLOR	HARDNESS	RUBBER
48153	\$ 3,05	■	Medium	3,0mm
48154	\$ 3,30	■	Heavy	4,0mm
48155	\$ 3,55	■	Ultimate	5,0mm
48156	\$ 4,45	■	Ultimate+	6,0mm

AMILA®

PREPARATION | FLEXIBILITY | TONING | HEALING

POWERBAND

Healing

After intense training, the muscles tighten, resulting in pain, stiffness and an increase to cramps.

AMILA PowerBand, providing leveraging and resistance, allows for larger stretches without pressuring the already strained muscles.

The resulting lengthening of the muscles finally assists their complete relaxation, which can shorten the recovery time and improve overall performance.

Flexibility

AMILA PowerBand helps improve flexibility and control of strength while stretching, so that each part of the joint works securely.

Much more than a simple exercise tool

Some good stretches help relaxing the muscles or preventing them cramping, even after a long journey.

STRETCH THERAPY

PowerBand

- > **Material:** Polyester + Latex
- > **Packaging:** Box

Scan here and discover your first exercises with AMILA PowerBand.

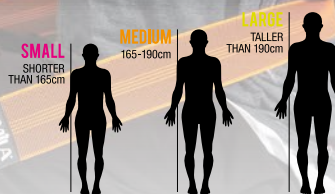

Find what suits you best

AMILA PowerBand can be used by people of all heights

CODE	PRICE	COLOR	LENGTH	SIZE	WIDTH
88241	\$ 5,10		81,5cm	S	
88242	\$ 5,50		96x6,5cm	M	6,5cm
88243	\$ 6,05		116cm	L	

Std Pack
60

Category
D10

Rubber Loop Band

- > **Material:** 100% SBR Rubber
- > **Length:** 104cm
- > **Thickness:** 4mm
- > **Maximum Elongation:** 500%
- > **Packaging:** Color box



CODE	PRICE	COLOR	HARDNESS	WIDTH	RESISTANCE
					200%
96607	\$ 2,85		Ultra Light	1,30cm	7Kg
96608	\$ 4,50		Light	2,00cm	12Kg
96609	\$ 6,85		Medium	3,20cm	18Kg
96610	\$ 9,35		Heavy	4,40cm	25Kg
96611	\$ 13,15		Ultra Heavy	6,40cm	36Kg

Std Pack
125

Κατηγορία
Δ10

Loop Band

- > **Material:** 100% Natural Latex
- > **Length:** 104cm
- > **Thickness:** 4,5mm
- > **Maximum Elongation:** 500%
- > **Packaging:** Hangable nylon bag with head-card



CODE	PRICE	COLOR	HARDNESS	WIDTH	RESISTANCE
					200%
88193	\$ 3,15		Ultra Light	0,63cm	5Kg
88194	\$ 4,90		Light	1,30cm	12Kg
88195	\$ 7,27		Medium	2,15cm	17Kg
88196	\$ 10,50		Heavy	3,15cm	26Kg
88197	\$ 14,60		Extra Heavy	4,45cm	33Kg
88198	\$ 19,60		Ultimate	5,20cm	52Kg

Std Pack
125

Category
D10

Small Loop Band

- > **Material:** 100% **Natural Latex**
- > **Length:** 30cm
- > **Width:** 5cm
- > **Maximum Elongation:** 500%
- > **Packaging:** Hangable nylon bag with head-card



CODE	PRICE	COLOR	HARDNESS	THICKNESS	RESISTANCE
					200%
96600	\$ 0,56		Ultra Light	0,4mm	2Kg
96601	\$ 1,07		Light	0,6mm	4Kg
96602	\$ 1,12		Medium	0,8mm	6Kg
96603	\$ 1,18		Heavy	1,0mm	8Kg
96604	\$ 1,68		Ultimate	1,2mm	10Kg

Std Pack 10 Category D10

Trinity Hip Loop Band Set

- > **Material:** 100% **Original Rubber**
- > **Length:** 34,5cm
- > **Width:** 6,5cm



3 Resistance Band Set and Carrying Pouch

Std Pack 40 Category D10

Combine then with foam rollers (p. 223), reformer towels (p. 234), pilates rings (p. 200) and socks (p. 204)

RUBBER HIPBAND



CODE	PRICE	COLOR	HARDNESS	THICKNESS	RESISTANCE
					200%
96616	\$ 4,12		Light	0,90mm	1,6Kg
			Medium	1,10mm	5,7Kg
			Heavy	1,25mm	8,0Kg

Small Loop Band Set

- > **Material:** 100% **Natural Latex**
- > **Length:** 30cm
- > **Width:** 5cm
- > **Maximum Elongation:** 500%



Scan here and discover your first exercises with AMILA Small LoopBands

Std Pack 40 Category D10

SET 4x DIFFERENT RESISTANCES
4 Resistance Band Set, Exercise Leaflet and Carrying Pouch

Physical Conditioning | Restoration | Strengthening
AMILA® LOOPBAND

CODE	PRICE	COLOR	HARDNESS	THICKNESS	RESISTANCE
					200%
96605	\$ 4,50		Light	0,6mm	4Kg
			Medium	0,8mm	6Kg
			Heavy	1,0mm	8Kg
			Ultimate	1,2mm	10Kg

Mini Band Set

- > **Material:** 100% **Original Rubber**
- > **Length:** 30cm
- > **Width:** 5cm



LATEXFREE
100% ORIGINAL RUBBER

Std Pack 50 Category D10

SET 4x DIFFERENT RESISTANCES
4 Resistance Band Set, Exercise Leaflet and Carrying Pouch

RUBBER LOOPBAND

CODE	PRICE	COLOR	HARDNESS	THICKNESS	RESISTANCE
					200%
96617	\$ 3,20		Light	0,70mm	8,5Kg
			Medium	1,00mm	9,0Kg
			Heavy	1,15mm	10,2Kg
			Ultimate	1,30mm	13,8Kg

Exercise with Eleanna Lima

All **AMILA GymBand Sets** include a leaflet of exercises with **Eleanna Lima**, graduate of Physical Education and Sports (TEFAA) and Organization of Physical Activity and Sports Recreation (DPTH)



AMILA
Physical Condition | Rehabilitation | Strengthening

GYMBAND



No more training without data!

All AMILA GymBands have information about the dimensions, nominal resistance and range of strength required for the exercise.

GymBand Resistance Chart

The **linearity of resistance** is the most important quality criterion for a band.

AMILA GymBands are the most common training and recovery choice of professionals.

COLOR	HARDNESS	THICKNESS	RESISTANCE					
			200%	250%	300%	350%	400%	450%
Yellow	Ultra Light	0,2mm	2,70Kg	3,95Kg	5,25Kg	2,70Kg	3,95Kg	5,25Kg
Green	Light	0,3mm	3,58Kg	5,70Kg	7,40Kg	3,58Kg	5,70Kg	7,40Kg
Red	Medium	0,4mm	4,65Kg	6,90Kg	9,05Kg	4,65Kg	6,90Kg	9,05Kg
Blue	Heavy	0,5mm	8,00Kg	11,80Kg	15,65Kg	8,00Kg	11,80Kg	15,65Kg
Black	Ultimate	0,6mm	9,05Kg	13,60Kg	18,05Kg	9,05Kg	13,60Kg	18,05Kg

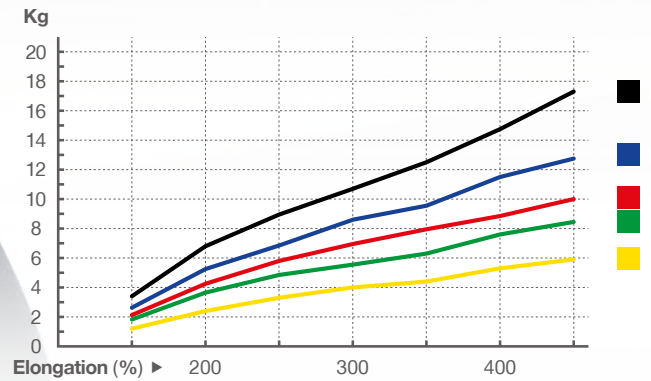

- > **Length:** 25m
- > **Width:** 14,5cm
- > **Material:** Latex
- > **Packaging:** Box



Gym Band Roll

CODE	PRICE	COLOR	HARDNESS
48144	\$ 19,50	Yellow	Ultra Light
48145	\$ 25,10	Green	Light
48146	\$ 33,00	Red	Medium
48147	\$ 36,00	Blue	Heavy
48148	\$ 42,70	Black	Ultimate
48149	\$ 46,90	Grey	Ultimate+
48150	\$ 51,20	Gold	Ultimate++



> **Packaging:**
New nylon bag with head-card



Category D10



> **Length:** 1,2m
> **Width:** 14,5cm
> **Material:** Latex
> **Packaging:** Nylon bag

Gym Band 1.2

CODE	PRICE	COLOR	HARDNESS
48180	\$ 1,04		Ultra Light
48181	\$ 1,40		Light
48182	\$ 1,65		Medium
48183	\$ 1,89		Heavy
48184	\$ 2,26		Ultimate

> **Packaging:**
New hangable box
Contains exercise leaflet



SET 3x DIFFERENT RESISTANCES
3 Resistance Band Set, Exercise Leaflet and Carrying Pouch

> **Length:** 1,2m
> **Width:** 14,5cm
> **Material:** Latex
> **Packaging:** Box

Gym Band 1.2 Set

CODE	PRICE	COLOR	HARDNESS
			Light
48178	\$ 6,20		Medium
			Heavy

Category D10

> **Packaging:**
New nylon bag with head-card



Category D10



> **Length:** 2,5m
> **Width:** 14,5cm
> **Material:** Latex
> **Packaging:** Nylon bag

Gym Band 2.5

CODE	PRICE	COLOR	HARDNESS
48185	\$ 1,94		Ultra Light
48186	\$ 2,55		Light
48187	\$ 3,20		Medium
48188	\$ 3,72		Heavy
48189	\$ 4,48		Ultimate

> **Packaging:**
New hangable box
Contains exercise leaflet



SET 3x DIFFERENT RESISTANCES
3 Resistance Band Set, Exercise Leaflet and Carrying Pouch

> **Length:** 2,5m
> **Width:** 14,5cm
> **Material:** Latex
> **Packaging:** Box

Gym Band 2.5 Set

CODE	PRICE	COLOR	HARDNESS
			Light
48120	\$ 10,60		Medium
			Heavy

Category D10

AMiLA® POWERGRIP

ONE ACCESSORY
MANY EXERCISES



96628

\$ 5,30

Power Grip

Λαβές Έλξεων - Πιέσεων

3 Distinct grips

ERGO GRIP



POWER GRIP



POWER+



SPECIFICATIONS

Material: TPR

Category: D10

88180

\$ 2,91

- > **Grip (diameter):** 3,5cm
- > **Grip (width):** 13cm
- > **Strap (width):** 3,8cm
- > **Packaging:** Hangable nylon bag with hang-tag

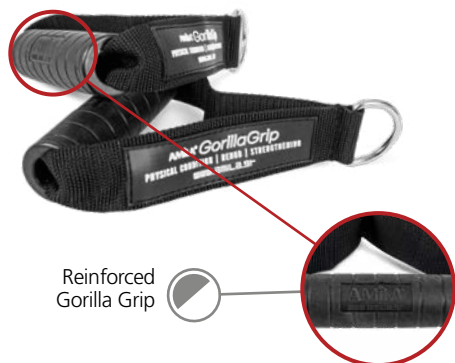

Reinforced
Gorilla Grip

Gorilla Grip

for Gym Tubes with Clip

88170

\$ 1,68

- > **Material:** PP
- > **Packaging:** Hangable nylon bag with hang-tag



Foam Grip

for Gym Tubes with Clip

PCS
2

Std Pack
70

Category
D10

PCS
2

Std Pack
100

Category
D10

96627

\$ 2,55

- > **Strap (width):** 6,5cm
- > **Ring:** "D" shaped, double, 5,6mm thick



Ankle Cuffs
for Gym Tubes with Clip

Reinforced Pillow from neoprene for maximum protection and soft feel

PCS 1 Category D10

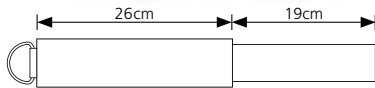

96626

\$ 5,90

- > **Strap (width):** 6,5cm
- > **Ring:** "D" shaped, single, 6,6mm thick



Reinforced Pillow from neoprene for maximum protection and soft feel

PCS 2 Category D10

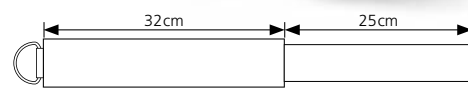

48179

\$ 1,82

- > **Strap (width):** 6cm
- > **Ring:** "D" shaped
- > **Packaging:** Hangable nylon bag with hang-tag

Wrist Cuff
for Gym Tubes with Clip

Reinforced Pillow from neoprene for maximum protection and soft feel



PCS 1 Std Pack 100 Category D10

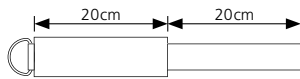

88172

\$ 3,56

- > **Strap (width):** 5cm
- > **Ring:** "O" shaped
- > **Packaging:** Hangable nylon bag with hang-tag

Ankle Cuffs
for Gym Tubes with Clip

Reinforced Pillow from neoprene for maximum protection and soft feel

Tightening Ring for maximum grip



PCS 2 Std Pack 50 Category D10

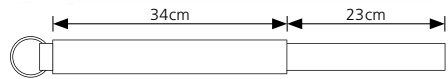

88174

\$ 1,32

- > **Strap length:** 22cm (folded)
- > **Packaging:** Hangable nylon bag with hang-tag



Door Fixing Hook
With strap for fastening tubes

Neoprene Lining for maximum tube protection

PCS 1 Std Pack 100 Category D10



88173

\$ 0,98

- > **Strap length:** 18cm (folded)
- > **Packaging:** Hangable nylon bag with hang-tag



Door Fixing Hook
With strap for fastening tubes

PCS 1 Std Pack 100 Category D10



88181

\$ 1,55

- > **Ring:** "O" shaped
- > **Strap length:** 42cm (ring included)
- > **Packaging:** Hangable nylon bag with hang-tag



Door Fixing Hook
With strap for fastening tubes

PCS 1 Std Pack 100 Category D10



88182

\$ 2,25

- > **Ring:** "O" shaped
- > **Strap length:** 78cm (ring included)
- > **Packaging:** Hangable nylon bag with hang-tag



Outdoor Mounting Hook
With strap for fastening tubes

PCS 1 Std Pack 100 Category D10

95362

\$ 23,90

SMART FITBODY 10 PRO

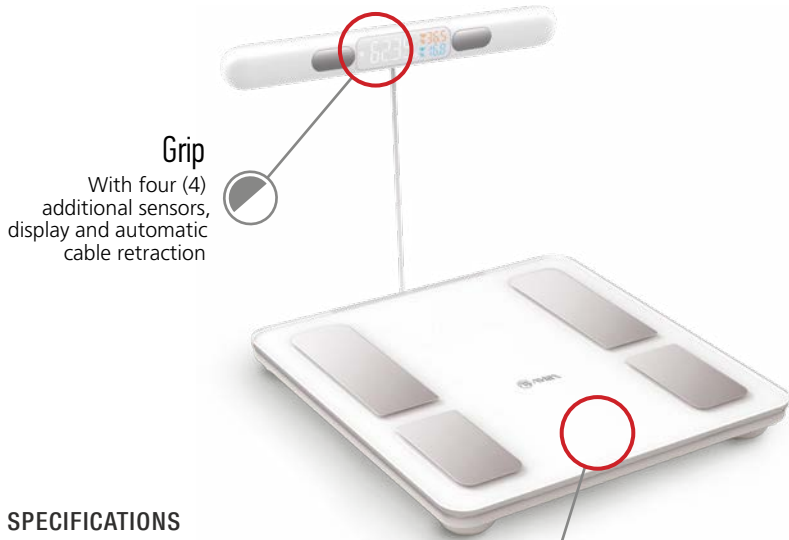

Grip

With four (4) additional sensors, display and automatic cable retraction

Accuracy

With the highest accuracy, regardless of the user's weight

SPECIFICATIONS

- Screen: LED with 18mm tall digits
- Accuracy: 10gr for a load of 100gr-10kg
- 50gr for a load of 10-180kg
- Batteries: 4 x AA (not included)
- Safety glass: 6mm
- Dimensions: 30,0x33,5cm
- Capacity: 180 kg
- Category: E4

95364

\$ 20,52

SMART FITBODY 8

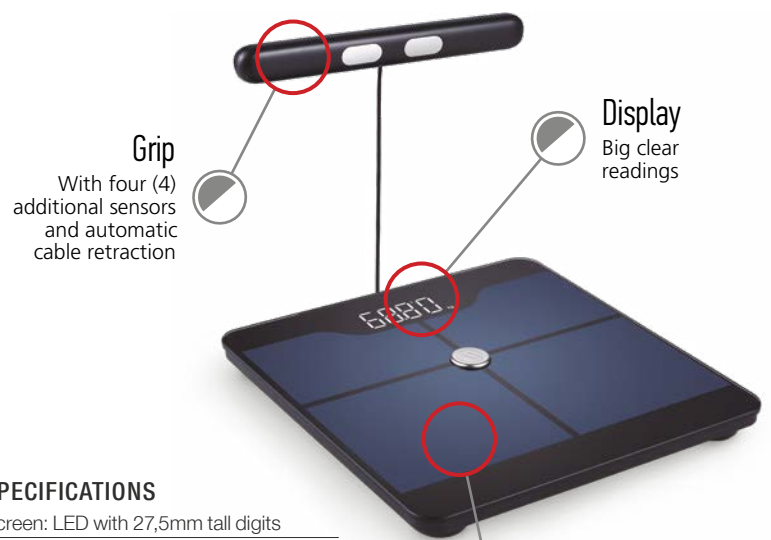

Grip

With four (4) additional sensors and automatic cable retraction

Display

Big clear readings

Glass

ITO type, eliminates the need for metal sensors

SPECIFICATIONS

- Screen: LED with 27,5mm tall digits
- Accuracy: 10gr for a load of 100gr-10kg
- 50gr for a load of 10-100kg
- 100gr for a load of 100-180kg
- Batteries: 4 x AA (not included)
- Safety glass: 6mm
- Dimensions: 30,0x35,0cm
- Capacity: 180 kg
- Category: E4



Wireless Data Transmission

The use of wireless technology to connect and transfer data between the scale and the application and the fast transmission of data ensure the best experience while using this scale. Furthermore, the ability to store the data for future comparison is extremely valuable for observing your progress.



Smart Analysis

User-friendly and simple user-interface presents the bodily changes over time concerning weight, BMI, body fat, muscle, bone, hydration and Kcal recommended. You can easily keep track of the data on your smart device anywhere and anytime and enjoy easy to understand tabular data and graphs. This scale is the first step for you to be in control of your health.



Multiple User Profiles

The ability to have multiple profiles, allows all family members to use the same scale, while everyone's data is kept in his own profile.



Data Sharing



Line Chart Analysis



Body Bone



Body Score



Lean Body Mass



BMR | AMR



Subcutaneous Fat



Body Hydration



Body Muscle



Auto-Recognition



Data Sync



Body Age



Skeletal Muscle



Multiple Users



iMoni App



History Data Review



Indications



Protein



Body Mass Index



Body Fat



Visceral Fat

95361

\$ 12,50

SMART FITBODY 5

Display

Big digits, simultaneous display of multiple data

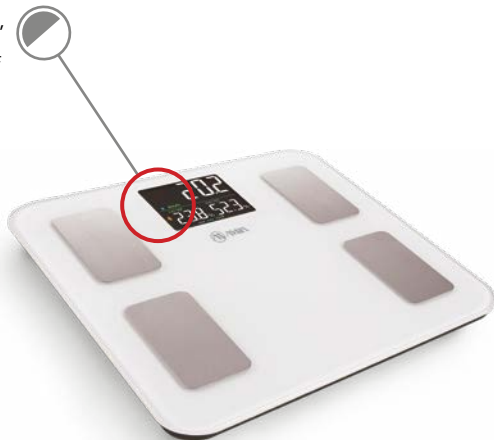

SPECIFICATIONS

- Screen: LCD, 80x74mm
- Accuracy: 50gr
- Batteries: 3 x AAA (not included)
- Safety glass: 6mm
- Dimensions: 30,3x30,3cm
- Capacity: 180 kg
- Category: E4

95363

\$ 10,20

SMART FITBODY 4R

Battery

Rechargeable, so you don't have to worry about running out of batteries

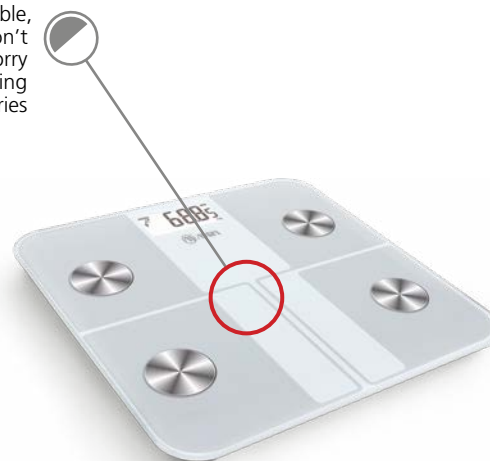

SPECIFICATIONS

- Screen: LCD 74x35,6mm
- Accuracy: 50gr
- Batteries: Rechargeable
- Safety glass: 6mm
- Dimensions: 30,3x30,3cm
- Capacity: 180 kg
- Category: E4

95360

\$ 5,85

SMART FITBODY 2

Dimensions

The smallest one, only 28x28cm

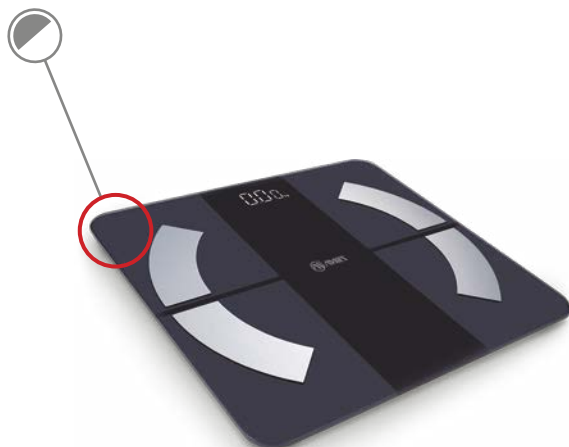

SPECIFICATIONS

- Screen: LED with 20,5mm tall digits
- Accuracy: 50gr
- Batteries: 3 x AAA (not included)
- Safety glass: 5mm
- Dimensions: 28,0x28,0cm
- Capacity: 180 kg
- Category: E4



compatible with the iMoni application

43796

\$ 35,00

- > **Dimensions:** 80x30
- > **Weight:** 18kg
- > **Material:** 840D Nylon Oxford
- > **Chain:** 5mm
- > **Ring:** 7mm



Category Z20

Boxing Bag

43795

\$ 50,20

- > **Dimensions:** 105x33
- > **Weight:** Approximately 20kg (shredded cloth)
- !!! **ADDITIONAL weight:**
The center of the bag is hollow with a PVC bag, where sand can be placed so that the weight can increase to 50kg
- > **Material:** PVC



Category Z20

Boxing Bag



43839

\$ 52,10

- > **Dimensions:** 120x35
- > **Weight:** 44kg
- > **Material:** PVC
- > **Filling:** Cloth scraps



Category Z20

Boxing Bag

- > **Material:** PU + PVC with Pro Bubble Wall
- > **Filling:** Cotton
- **Pro Bubble Wall:** Special foam material inside for absorbing the blows and keeping the shape

Boxing Bag



Category Z20

CODE	PRICE	DIMENSIONS	WEIGHT
43845	\$ 60,98	90 x 30	18-20 Kg
43846	\$ 66,02	100 x 30	28-30 Kg
43847	\$ 78,86	120 x 30	32-34 Kg
43848	\$ 92,90	150 x 35	38-40 Kg

- **Pro Bubble Wall:** Special foam material inside for absorbing the blows and keeping the shape

Boxing Bag



Category Z20
 > **Material:** PU + PVC
 > **Filling:** Pressed cloth scraps

CODE	PRICE	DIMENSIONS	WEIGHT
43815	\$ 53,95	90×30	18-20 Kg
43816	\$ 59,73	100×30	23-25 Kg
43817	\$ 64,90	120×30	24-26 Kg
43818	\$ 97,92	150×35	28-30 Kg

Boxing Bag



Category Z20
 > **Material:** Black woven clip mesh pvc
 > **Filling:** Renewable sponge + EPE + cloth

CODE	PRICE	DIMENSIONS	WEIGHT
96851	\$ 65,30	100×35	40 Kg
96852	\$ 78,50	125×35	50 Kg
96853	\$ 91,20	150×35	60 Kg

Pro Bubble Wall

Special foam material for absorbing blows



Category Z20

CODE	PRICE
43840001	\$ 6,00
43841001	\$ 6,90
43842001	\$ 7,90
43843001	\$ 8,90

Boxing Bag



Category Z20
 > **Material:** PVC
 > **Sold empty**

CODE	PRICE	DIMENSIONS
43840	\$ 20,50	90×35
43841	\$ 22,70	120×35
43842	\$ 26,70	150×35
43843	\$ 41,06	180×35

43087

\$ 13,10

Boxball "F3"



SPECS

Material: Synthetic leather

Diameter: 25 cm

Std Pack: 8

Category: Z20

43794

\$ 180,00

- > **Material:** Oxford fabric
- > **Base:** Ø42x35cm filled with iron

- + Natural size
- + Competitive price
- + Very fast reset
- + High durability
- + Designed in the USA



Conveniently located handles on top and base allow for easy maneuverability



Free Punching

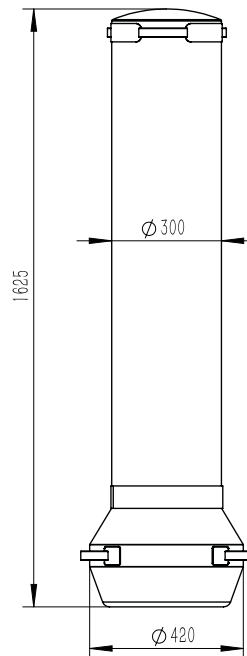

+ The **outer material** is resilient against punches, kicks, knees, and elbows

+ **Throw it on the floor** and easily practice other types of strikes

+ The **high weight** of the base brings it back to a standing position even after the hardest hit

Weight
45kg

Category
Z20

Ø30×162cm

32009

Elastic Hand Wraps

Elastic
For a better
fit and feel



SPECS

Material: High quality
cotton 60%,
Nylon 15%,
Spandex 25%

Pcs: 2
Length: 4,5m
Closure: Velcro
Std Pack: 48
Category: Z21



Hand Wraps



SPECS

Material: 65% cotton,
35% polyester mesh
Pcs: 2
Length: 3,0m
Closure: Velcro
Std Pack: 48
Category: Z21

CODE	PRICE	LENGTH	COLOR
32000	\$ 2,65	3,0 m	
32001	\$ 2,65		
32003	\$ 3,30	4,5 m	
32004	\$ 3,30		

Elastic Hand Wraps



SPECS

Material: Extra thick woven material
Pcs: 2
Length: 3,0m
Closure: Velcro
Std Pack: 100
Category: Z21



CODE	PRICE	COLOR
32043	\$ 2,15	White



“Forte” MMA & Bag Mitts



> **Material:** PU

CODE	PRICE	SIZE
43702	\$ 8,16	Small
43703	\$ 8,16	Medium
43704	\$ 8,16	Large
43705	\$ 8,16	X-Large

Category Z20

37456

\$ 5,40

- Suitable for a bag weighting up to 80kg (depending on the hardness/durability of the concrete)



Boxing Bag Mount for the Ceiling

Fastened with 2 screws

Category Z20

Bag Mitts



> **Material:** PU

CODE	PRICE	WEIGHT
37301	\$ 10,35	10 Oz
37302	\$ 11,09	12 Oz

Category Z20

“Kaos” Bag Mitts



> **Material:** PU Matt

CODE	PRICE	SIZE
37167	\$ 8,52	Medium
37168	\$ 8,52	Large
37169	\$ 8,52	X-Large

Category Z20

**“Forte”
Boxing Gloves**



SPECS

Material: PU
Category: Z20

CODE	PRICE	WEIGHT	STD PACK
32006	\$ 14,35	10 Oz	8
32007	\$ 14,35	12 Oz	
32008	\$ 14,35	14 Oz	6

Category
Z20

“Kaos” Boxing Gloves



> Material: PU Matt

CODE	PRICE	WEIGHT
37155	\$ 13,40	10 Oz
37156	\$ 13,40	12 Oz
37157	\$ 13,70	14 Oz

**“Re-Born”
Boxing Gloves**



> Material: Leather

CODE	PRICE	WEIGHT
37140	\$ 19,25	10 Oz
37141	\$ 19,25	12 Oz
37142	\$ 19,90	14 Oz
37143	\$ 19,90	16 Oz

Leather  Category
Z20

Category
Z20

Boxing Gloves



> Material: PU
> Packing: Velcro polybag

CODE	PRICE	WEIGHT
37331	\$ 12,70	10 Oz

Boxing Gloves



- > **Material:** PU
- > **Packing:** Velcro polybag

CODE	PRICE	WEIGHT
37328	\$ 13,21	10 Oz
37329	\$ 13,21	12 Oz
37330	\$ 13,21	14 Oz

Category Z20

Head Guard



- > **Material:** Leather
- > **Filling:** Foam

CODE	PRICE	SIZE
37247	\$ 23,50	L

Leather Category Z21

"Kaos" Head Guard



- > **Material:** PU Matt

CODE	PRICE	SIZE
38000	\$ 13,20	S
38001	\$ 13,20	M
38002	\$ 13,20	L
38003	\$ 13,20	XL

Category Z21

"Asroc" Head Guard



- > **Material:** PU

CODE	PRICE	SIZE
38005	\$ 9,61	M
38006	\$ 13,83	XL

Category Z21

43885

\$ 13,20

Αχλάδι Οροφής



SPECIFICATIONS

Material: PU + PVC
 Height: 29 cm
 Perimeter: 63 cm
 Std Pack: 16
 Category: Z20

Speed Ball



SPECIFICATIONS

Material: Leather
 Std Pack: 16
 Category: Z20

CODE	PRICE	SIZE
43887	\$ 10,20	4
43888	\$ 10,80	5

37291

\$ 18,63

“Forte” Shield

> Material: PU



38640

\$ 13,65

“Kaos” Target



SPECS

Material: PU
 Pcs: 2
 Weight: 270gr
 Dimensions: 26,5x18,5x8cm
 Std Pack: 5
 Category: Z21

PCS 2	Weight 520gr	Category Z21
----------	-----------------	-----------------

35x20,5x13cm



2018
INNOVATIVE
PRODUCT
AWARD



Easy Two-Step Folding
and Transport Wheels



Adjustable
Glideboard

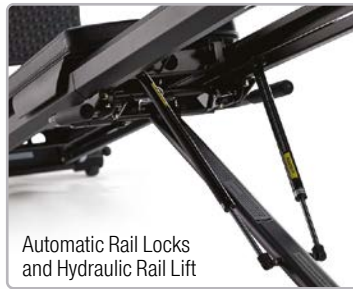

Automatic Rail Locks
and Hydraulic Rail Lift



Squat Stand



Retractable
Dip Bars



LAT Bars

Molded
Handles

6 Center
Pulley
Attachment
Positions

WWW
TOTAL-GYM
.GR



46361

\$ 3.100,00

Category
F2

ENCOMPASS

DIMENSIONS	in-use: 2,7m × 1,0m × 1,8m folded: 0,5m × 1,0m × 1,4m
WEIGHT	81,65Kg
RAIL CONSTRUCTION	Steel reinforced extruded aluminium rails
RESISTANCE	1% to 62% of bodyweight
LEVELS	22 calibrated incline levels, with release lever to lock rails in place
SQUAT STAND	3 height levels
STORAGE	Hydraulic lift assists folding; rolls upright when folded
USER HEIGHT	2,1m (max)
CAPACITY	Total 295Kg (max) User 160Kg (max)
WARRANTY	Frame: 5 έtn Parts & Upholstery: 1 έτος Foam & Rubber: 90 ημέρες

ENCOMPASS™ now part of our ELEVATE™ series and is the award-winning equipment anchor for GRAVITY®, the time-efficient, **personal training, group fitness and Pilates program** that is generating excitement and new revenue in commercial facilities around the world.

1. Adjustable glideboard promotes optimal spinal alignment and training variations.
2. Automatic rail locks allow for explosive plyometric jumping.
3. Hydraulic rail lift assists level changes and easy two-step folding.
4. Multiple center-pulley attachment positions double arm-cable load and increases lower extremity ROM.
5. LAT bars promote line-of-pull precision for arm-cable exercises.
6. Now comes with Retractable Dip Bars included on unit. Strength and Pilates Packages available for purchase. Individual accessories for purchase include: SCRUNCH®, Press Bar, Weight Bar, 3Grip Pull-up Bar, Dynamic Leg Pulley System, Telescoping Toe Bar, Leg Pulley System, Slide Distance Regulator and Standing Platform.

You can follow a **total-body workout** that combines more than 250 exercises, using the same machine, using only your body weight as resistance!

GRAVITY is for everyone, even for children, since it works using the body's weight and the difficulty level is adjusted according to the user.

Exactly this, **avoiding the use of any foreign powers** as resistance (bands, springs, weight etc.), along with the **huge range of motion and exercises**, gives you **complete control** and the **confidence** to even work on **injury rehabilitation** on each joint separately or all together.



GET A TOTAL BODY WORK

TOTAL GYM

STAND OUT

Competition is relentless

Don't use only the "well known"

Be innovative in your business

Focusing on strength, endurance, mobility and stability, you can create a complete circuit training program for personal or group use, even incorporating the equipment available in your studio or gym.

Get the whole ELEVATE series and setup your own circuit training course like no other.



ELEVATE ROW ADJ

Emulates a rowing movement pattern using 7 levels of adjustable bodyweight resistance. Produces a full-body workout, integrating a strength component into a fully adjustable cardio machine.

ELEVATE CORE ADJ

Strengthens the abdominals while engaging the entire core musculature. Offering unparalleled versatility for an abdominal machine, the Adjustable Core is a plank facilitator that allows for two primary movements, the Dynamic Plank and the SCRUNCH.

ELEVATE ENCOMPASS

Encompass is now part of our ELEVATE series and is the award-winning equipment anchor for GRAVITY®, the time efficient, personal training, group fitness and Pilates program that is generating excitement and new revenue in commercial facilities around the world.

A ROWING MACHINE LIKE NO OTHER

Strength Component + Super Cardio Machine

Be relentless with your demands for the best training experience

Scan the QR code, enter the YouTube Channel of TotalGym and learn of the exercises you can do with ELEVATE Row - Adjustable



TotalGym® continues to innovate with the ELEVATE™ line. A sleek matte black finish, combined with a full adjustable incline, transforms a functional training machine to something that will truly **upgrade** your business and will allow you to create **innovative** programs.

TOTAL GYM 

Rediscover rowing

There is no other rower with incline in the market.

The exercise experience cannot be compared with any other traditional machine.

The entertainment level remains high until the end of the exercise and the effectiveness is truly unmatched.

We challenge you to observe the face of a user and only then will you understand what we mean!



Incline Release Lever to move between seven levels of resistance.



Monitor displays rowing time, split time (minutes per 500 meters), strokes per minute, total distance and total calories burned.



Instructional Placard provides at-a-glance exercises. **QR code** and **URL** provides smart phone links to **exercise videos**.

Anchor Feet with Bolt Holes for safety and stability.



Ergonomically Designed Seat designed for comfort and to encourage proper form.

Transport wheels



Improved Handle Design Shipping with New Units (not pictured above) features ergonomic grips at both ends providing control and comfort throughout movements.



46364

\$ 1.550,00

Category
F2

Row Adjustable

DIMENSIONS	2,5m × 0,83m × 1,06m [1,1 s.m. of floor space]
WEIGHT	48Kg
CONSTRUCTION	Steel with steel reinforced extruded aluminum rails
RESISTANCE	7 levels of incline
TRANSPORT	Integrated transport wheels
INSTALLATION	Designed to be bolted to the floor
WARRANTY	frame: 5 years moving parts & upholstery: 1 year rubber & foam material: 90 days

An ingeniously unique rower that emulates a rowing movement pattern using adjustable bodyweight resistance, the **ELEVATE Adjustable Row™** produces a full body workout, integrating a strength component into a fully adjustable cardio machine.

The **ELEVATE Adjustable Row™** targets all the muscles groups simultaneously and enables a smooth consistent load through the entire range of motion, due to loaded concentric and eccentric phases of the exercise.

- 1. Upgrade on previous design:** User can choose between seven levels of resistance which uses a percentage of bodyweight. Note that this version *does not fold*.
- Adjustable incline body resistance integrates strength with cardio.
- Smooth consistent load through concentric and eccentric phases.
- Built for multi-planar movement.
- Low impact compression on the joints.



Learn everything about TotalGym and GTS



Adjustable glideboard

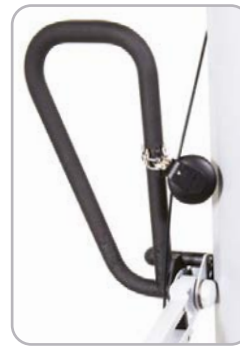

LAT bars



2018 INNOVATIVE PRODUCT AWARD



Integrated folding and transport wheels

COME OUT A WINNER EXERCISE, FOLD & FREE THE ROOM AGAIN, AT THE SAME SPEED IT TOOK TO READ THIS!



Squat Stand (βάση για Βαθύ Κάθισμα)



Rail locks and hydraulic lift assist



Multiple center-pulley attachment positions

46359

\$ 2.300,00

Category F2

GTS

DIMENSIONS in-use: 2,7m × 1,0m × 1,8m
folded: 0,5m × 1,0m × 1,4m

WEIGHT 81,65Kg

RAIL CONSTRUCTION Steel reinforced extruded aluminium rails

RESISTANCE 1% up to 62% of body weight

LEVELS 22 incline levels, with safety locking mechanism

SQUAT STAND 3 height levels

FOLD Hydraulic assistance with transport wheels. Rolls upright

USER WEIGHT 2,1m (max)

CAPACITY total 295Kg (max)
user 160Kg (max)

GUARANTEE frame: 5 years moving parts & upholstery: 1 year rubber & foam material: 90 days

The **TOTALGYM® GTS™** is the award-winning equipment anchor for **GRAVITY®**, the time-efficient, personal training, group fitness and Pilates program that is generating excitement and new revenue in commercial facilities around the world.

1. Adjustable glideboard promotes optimal spinal alignment and training variations.
2. Automatic rail locks allow for explosive plyometric jumping.
3. Hydraulic rail lift assists level changes and easy two-step folding.
4. Multiple center-pulley attachment positions double arm-cable load and increase lower extremity ROM.
5. LAT bars promote line-of-pull specificity for arm-cable exercises.
6. Includes workout DVD and exercise wall chart.
7. Most popular accessories include **SCRUNCH®**, Press Bar, Retractable Dip Bars, Weight Bar, 3Grip Pull-up Bar, Dynamic Leg Pulley System, Toe Bar for Pilates.

Benefits for the Trainee:

- Effective full body workout producing fast results.
- Definition – Activates the abdominal and back muscles in every exercise.
- Increases strength and endurance.
- Improves balance.
- Weight lose and measurements decrease, improving Body Mass Index.
- Increases metabolism.
- Improves the functional performance of daily activities.
- Offers cardio-endurance during high resistance training.
- Zero impact, safe, with full back support.

Applications and Industrial:

- Partial loading of Closed Kinetic Chain joints.
- Exercises in three basic levels and multi-level movement (3D).
- Adjustment of the cable-pulley power angles according to the dimensions of the trainee, his perimeter and exercise aim.
- Trains stabilisers and proprioception to improve position, speed and direction of the body parts.
- Specialised exercises energising movement.
- Explosive upper and lower limb plyometric training.
- Full-body support, friendly to the joints, which does not create compression.
- More than 250 exercises and variations.
- Advanced Pilates for bot training and education.
- Reliable tool for assessing lower body strength.
- Full range of educational DVDs (and on-line) available.



Ανακάλυψε
όλες τις ασκήσεις του
JumpTrainer



46373
\$ 1.150,00

Category
F2

Jump Trainer

DIMENSIONS	2,6m × 0,8m × 1,7m [2,2 s.m. of floor space]
WEIGHT	105Kg
RAIL CONSTRUCTION	Steel reinforced extruded aluminium rails
RESISTANCE	For Physical Therapy: 30%-65% of body weight For Exercising: 50%-80% of body weight
BANDS	4,5-32Kg added adjustable resistance in 4,5Kg steps
USER WEIGHT	180Kg (max)
TRANSPORT	Integrated transport wheels
INSTALLATION	Designed to be bolted to the floor
GUARANTEE	frame: 5 years moving parts & upholstery: 1 year rubber & foam material: 90 days

The exceptional safety levels, its innovative features and resistance variability that **Jump Trainer** offers

make it **usable** by users with any **physical condition** and to be **recommended even for physiotherapy!**

The **TOTALGYM® JUMP TRAINER™** builds **explosive power** and develops **muscle mass** on the lower part of the body with to main moves, **squat** and **squat jump**.

- It stands out for its unique design which facilitates as no other machine the plyometric exercises, fully utilizing the linear resistance of body weight and the variable resistance from the tubes. Four zones with bands can be used to offer resistance from 4,5 to 32Kg in 4,5Kg steps.
- **JUMP TRAINER™** produces both concentric and eccentric muscle loading, allowing users to quickly accelerate and decelerate during a squat jump with a secure, controlled manner and the help of the pneumatic break that guarantees protection of the joints.
- Supports the spine so that users can easily control the phases of traditional exercises, while at the same time offering the ability for more inventive variations to be created.
- The excellent security levels allows it to be used by trainees regardless their fitness level and to be recommended even for physiotherapy.

TWO LEVELS OF RESISTANCE

Physiotherapy and Fitness, each allows for seven incline levels, ranging from 30 to 80% of the user's body weight.

COME OUT
A WINNER

EXERCISE, FOLD
& FREE THE
ROOM AGAIN,
AT THE SAME
SPEED IT TOOK
TO READ THIS!

Adjustable glideboard
angle with automatic
locking



Seven central pulley
hooking positions



Adjustable
grips

Folding
support
grips



Grips with
integrated
remote control

Removable
Squat Stand

Integrated
folding and
transport
wheels



Hydraulic
assistance

Examples of
Rehabilitation
Exercises



46365

\$ 5.200,00

Category
F2

Power Tower

DIMENSIONS	in-use: 2,7m × 1,0m × 2,0m folded: 0,5m × 1,0m × 1,7m
WEIGHT	99Kg
RAIL CONSTRUCTION	Steel reinforced extruded aluminium rails
RESISTANCE	1% to 72% of body weight
GRADUATIONS	26 calibrated levels of incline, with infinite adjustments between levels
SQUAT STAND	3 height settings
FOLDING	Hydraulic assistance with transport wheels. Rolls upright
USER HEIGHT	2,1m (max)
CAPACITY	total 295Kg (max) user 160Kg (max)
GUARANTEE	frame: 5 years moving parts & upholstery: 1 year rubber & foam materials: 90 days

21 MILLIONS
psychotherapy
patients per
month in 14.000
clinics

Functional training with incline using TOTALGYM® equipment provides the optimal experience, recruiting multiple muscle groups in tandem and make exercising more productive.

Total Gym delivers exceptional results on every level, serving more than 15 million people every year with the awarded design and functionality of its products.

WHY INCLINE;

- Partial loading of the joints
- Excellent feel of control and balance
- Unlimited range of motion
- Works on the three basic levels, plus multi-level movement (3D)
- Increases the position, speed and direction of body parts and helps the brain to guide the movements
- Trains the stabilisers
- Explosive plyometric training of upper and lower limbs
- Full-body support, joint friendly (non-compressive)
- More than 250 strength exercises and variations
- Advanced Pilates training
- Reliable tool for assessing lower-body strength
- Specialised increase in endurance and toughness, kinetics of sports included.

SPEED-UP RECOVERY

BECOME THE BEST

Don't stick to the old methods

Achieve quick restoration

Take smart advantage of your space

RESEARCH PROVES TOTAL GYM MACHINES —COMPONENT OF THE GRAVITY SYSTEM— ARE THE MOST RELIABLE TO PERFORM MEASUREMENTS OF PERFORMANCE AFTER AN INJURY RECOVERY PERIOD

In the past there were few options available for injury rehabilitation specialists and fitness instructors to measure lower extremity performance in individuals with limited weight bearing capacity.

In the past, specialists had to rely on hands-on muscle tests (often imprecise) to determine endurance and functional performance in a patient recovering from a lower extremity injury.

So there was a need to create an accurate measurement to track the patient's progress, which would happen earlier, during the recovery process.

The University of San Diego (School of Physical Education and Nutritional Sciences) and the University of Toledo (Health Science) conducted a study to measure the reliability and validity of the Total Gym as a coherent tool to measure leg strength. The results of the study were published in the North American Journal of Sports Physical Therapy in May 2009. **The research found out that measuring leg performance using Total Gym's instruments provides significant results regarding a patient's current functional status -earlier- in the rehabilitation and recovery process. The tests performed provided reliable data to detect the patient's condition, such as functional improvement, presentation of change or loss of patient performance.**

Thus, Total Gym equipment evolved from exercise equipment for patient rehabilitation to measurement tools to provide valid information on a patient's progress toward full weight-bearing function. Since, according to the results, the trainees felt that they could - really - put in more effort with TotalGym, since they were not afraid of falling or injuring themselves.

TotalGym® specializes in functional bodyweight training equipment that allows clinicians to build injury-specific treatment and training that can **accelerate patient outcomes.**

PowerTower™ maintains a therapeutic profile that enhances performance possibilities and offers the flexibility to meet the demands of rehabilitation.

46363

\$ 1.550,00

- Provides dedicated area for planking
- Rolling glideboard offers option to increase instability
- Ability to progress or regress exercises by changing body position
- Offers 7 levels of resistance
- Designed to be bolted to gym floor
- Integrated transport wheels

SCRUNCH Forearm Pad features an ergonomic grip bar for stabilization and a high-density foam cushion with box-stitched vinyl upholstery

Exercise Placard with QR code to exercise videos

Rolling Padded Glideboard allows for multiple progression options

Rubber Foot Plate for safety and comfort

Incline Release Lever

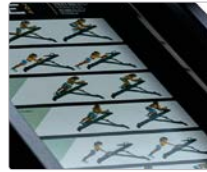

Floor Anchor Bolt Holes



Core Trainer

Range of Motion: 787mm

Rails: Steel reinforced extruded aluminum rails

Weight: 40Kg

Max User Weight: 181Kg

- Warranty: Frame - 5 years, Rubber & Moving Parts - 1 year, Upholstery - 90 days;

180x83x129cm

Category F2

46374

\$ 966,00

- XLow compression on the joints, especially the lower spine
- Full leg and shoulder strengthening
- The resistance incline can be raised or lowered to adapt to all needs
- Designed to adapt to all body sizes
- Integrated transport wheels

Exercise Computer



Exercise placard



Ergonomically Designed Seat



Row Trainer

Counter: Time, minutes/500m, pull-ups/min, distance, calories

Rails: Steel reinforced extruded aluminum rails

Weight: 44,5Kg

Max User Weight: 181Kg

- Warranty: Frame - 5 years, Rubber & Moving Parts - 1 year

250x60x80cm

Category F2

46372

\$ 660,00

- Unique closed chain design reduces shoulder impingement and stabilizes the shoulder girdle
- Inverted position unloads the lower back and reduces spinal compression
- Ability to progress exercises by adding plyometric movement
- Seven levels of resistance
- Designed to be bolted to gym floor.
- Integrated transport wheels



Press Trainer

Resistance: 15% to 50% of bodyweight

Range of Motion: 840mm

Rails: Steel reinforced extruded aluminum rails

Weight: 53Kg

Max User Weight: 181Kg

- Warranty: Frame - 5 years, Rubber & Moving Parts - 1 year, Upholstery - 90 days;

170×100×100cm

Category
F2

46371

\$ 677,00

- Adjustable incline design allows for partial bodyweight pull-ups.
- Ability to progress exercises by adding plyometric movement
- Offers four basic hand grip positions
- Designed to be bolted to gym floor.
- Integrated transport wheels



Pull-up Trainer

Resistance: 30% to 60% of bodyweight

Range of Motion: 840mm

Rails: Steel reinforced extruded aluminum rails

Weight: 55Kg

Max User Weight: 181Kg

- Warranty: Frame - 5 years, Rubber & Moving Parts - 1 year, Upholstery - 90 days;

180×110×110cm

Category
F2

46370

\$ 535,00

- 15" Step-Up/Box Jump platform
- Designed to be bolted to gym floor.
- Integrated transport wheels



Leg Trainer

Range of Motion: 565mm

Rails: Steel reinforced extruded aluminum rails

Weight: 54Kg

Max User Weight: 181Kg

- Warranty: Frame - 5 years, Rubber & Moving Parts - 1 year

150×60×40cm

Category
F2

46350

\$ 128,00

Leg Pulley System



Category
F2

46351

\$ 115,00

Pull-up Bar



Category
F2

46352

\$ 151,00

Press Bar



Category
F2

46353

\$ 169,00

Scrunch



Category
F2

46354

\$ 112,00

Telescopic Toebar



Category
F2

46356

\$ 134,00

Standing Platform



Category
F2

46357

\$ 43,00

Weight Bar



Category
F2

46358

\$ 49,00

Squat Handlebar



Category
F2

TOTAL GYM

STAND OUT

Competition is relentless

Don't use only the "well known"

Be innovative in your business

ERGONOMICS & SAFETY

TOTALGYM® design benefits both the fitness instructor and the trainee. As the user trains in an inclined position, does not have to bear all of his weight. Thus, the pressure on the joints is minimized, both for beginners and those with special injury issues and need to be taken care of. In addition, the space

required by the **ENCOMPASS™** line and the **GTS™** can be minimized so that it will not take space in the room. After completing the exercises, they fold and stored at a corner, not needing more space than half s.m., leaving the space free for other exercises or functions in your business or home.

No other single instrument is supported with such a wide range of information.



Be an Innovator

Only if you pursue your business will you stay strong.

Only if you constantly pursue the best can you evolve.

Only if you innovate can you stand out.



Είμαστε παθιασμένοι με την πεποίθηση ότι το να διατηρείσαι fit μπορεί να σου προσφέρει μια ευτυχέστερη και υγιέστερη ζωή. Ο στόχος μας είναι να αναπτύξουμε εξατομικευμένες εμπειρίες υγείας και φυσικής κατάστασης που θα βοηθήσουν τους ανθρώπους να ζήσουν τις ζωές που επιθυμούν.

Πάνω από είκοσι χρόνια προσπαθούμε να εξελίξουμε τη γυμναστική με έμφαση στην εργονομία, επαναπροσδιορίζοντας συνεχώς τα επίπεδα καινοτομίας και ποιότητας, με στόχο τη βελτίωση της προσωπικής ευεξίας.

AMILA® Renegade

Μάθε τα πάντα για τη σειρά AMILA Renegade μέσα από το πλήρως ενημερωμένο site: amila-air.gr

Δεν πρόκειται για μια συνηθισμένη σειρά AIR!

Τα Renegade συμμετέχουν στα σημαντικότερα CrossFit Events και δεν είναι τυχαίο που συγκαταλέγονται ανάμεσα στα καλύτερα του κόσμου.

LOW-IMPACT, TOTAL-BODY WORKOUT

Η σειρά AMILA Renegade δίνει τη δυνατότητα στον ασκούμενο να αναλάβει δράση για την τέλεια προετοιμασία και την απόλυτη καύση των θερμίδων του **χωρίς καμία επώδυνη πρόσκρουση στις αρθρώσεις**. Ιδανικά τόσο για την προθέρμανση, πριν την προπόνηση, όσο και για την απόλυτη προετοιμασία.

ΚΟΥΡΦΑΙΑ ΥΛΙΚΑ

Τα Renegade είναι κατασκευασμένα για να νικούν. Οι **βαρέως τύπου διπλές λεπίδες** των καλύβδινων πτερυγίων, τα **διπλά σφραγισμένα ρουλεμάν επαγγελματικής χρήσης**, τα **πολλαπλής κατεύθυνσης έδρανα** και οι **βιομηχανικοί ιμάντες κίνησης Poly-V** εγγυώνται τα δυο σημαντικότερα χαρακτηριστικά της σειράς: **Διάρκεια και Αντοχή**.

ΑΠΕΙΡΗ ΕΝΤΑΣΗ & ΑΝΤΙΣΤΑΣΗ

Σε αντίθεση με τους άλλους τύπους οργάνων γυμναστικής, τα προϊόντα αέρα παρέχουν το πλεονέκτημα της **απεριόριστης αντίστασης στην αιολική ενέργεια**, προσαρμοσμένο για κάθε επίπεδο προπόνησης.

ΕΞΑΙΡΕΤΙΚΟ ΕΡΓΑΛΕΙΟ ΑΠΟΚΑΤΑΣΤΑΣΗΣ

Είναι εξαιρετικά εργαλεία για την αποκατάσταση, καθώς παρέχουν **ασφαλή κίνηση χωρίς καμία επίδραση**. Επιπλέον, διευκολύνουν την **αιμάτωση της περιοχής τραυματισμού** βοηθώντας με αυτόν τον τρόπο στην ταχύτερη αποκατάσταση.

HIGH INTENSITY INTERVAL TRAINING (HIIT)

Τα όργανα γυμναστικής με φυσική αντίσταση είναι **τα απόλυτα εργαλεία της διαλειμματικής προπόνησης (HIIT)**.

ΨΥΞΗ

Τα AMILA Air Bike (Ποδήλατο) & Air Rower (Κωπηλατική) παρέχουν στους ασκούμενους ένα **δροσιστικό κύμα αέρα**, κατά την εκτέλεση της προπόνησης, μέσω του ανεμιστήρα αντίστασης που διαθέτουν στο εμπρός μέρος.

amila-air.gr

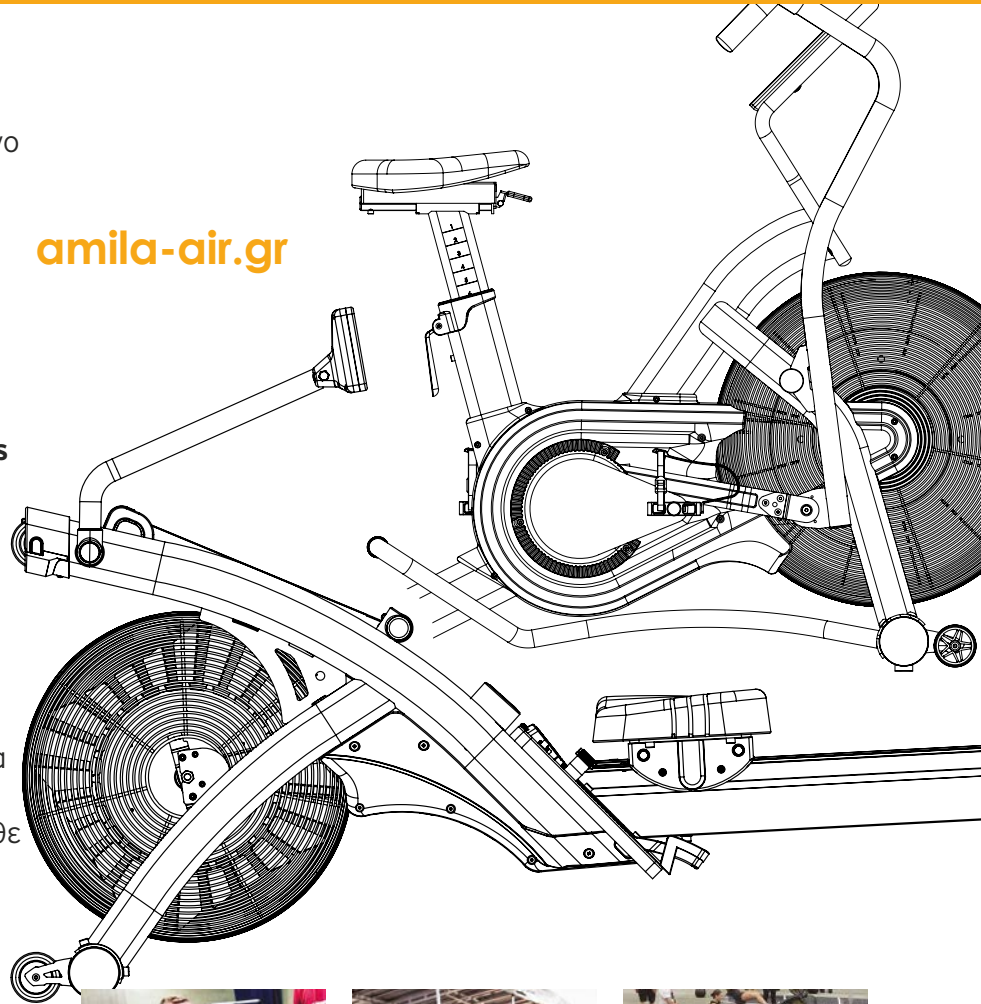

93810

\$ 658,00

Air Mag Rower

Ergonomic Handles,
2 pairs for different
exercises

POLAR
COMPATIBLE



Smooth, natural,
unlimited airflow/
magnetic resistance
from a heavy-duty
45cm aluminum fan

Large LCD Screen
with wireless heart receiver.

SPECIFICATIONS

- Dimensions: 62,0x20,0x75,0 cm

- Console: LCD back-light

- Readings: Time, Stroke, Stroke/min, Distance, Calories, Time/500m, Watts, Heart rate

- Programs: 8 (20/10, 20/30, custom intervals, 4 x target settings and H.R.C.)

- Resistance: Magnetic, 14 levels

- MAX user weight: 150 kg

- NET weight: 27,5 kg

- Category: F2

3 distinct mounts

Combine the Air Ski with one of the three mounts, according to your needs.

93807

\$ 90,00

Wall Mount

Fixed



SPECIFICATIONS

- Dimensions: 29,0x7,0x44,0 cm

- Material: Steel 4mm thick

- NET weight: 5 kg

- Category: F2

93808

\$ 253,00

Wall Mount

Adjustable



Quick release locking
system to place
the main unit in
desired position and
orientation

SPECIFICATIONS

- Dimensions: 49,0x37,0x229,0 cm

- Material: Steel 2mm thick

- NET weight: 52 kg

- Category: F2

93809

\$ 494,00

Platform

Adjustable



SPECIFICATIONS

- Dimensions: 60,0x128,0x207,0 cm

- Material: Steel 2,3mm thick

- NET weight: 83,5 kg

- Category: F2

TECHNOLOGY

- Large LCD screen with a wireless receiver displays all workout data in easy to read format

- Tracks time, stroke, stroke per minute, distance, calories, time per 500 meters, watts, and heart rate

- Target, interval and heart rate programs

COMFORT

- Ergonomic handles (2 pairs for different exercises)

- Smooth, natural, unlimited airflow/magnetic resistance

- Lightweight, low maintenance, high-strength drive cords for smooth feel and long life

- Infinitely design Stainless Steel quick exchangeable mechanism design for vertical & horizontal grip handles used for different exercises requirements

CONSTRUCTION

- Super internal drive mechanism with robust FC 2016 sealed cartridge one-way bearing and also 6203 sealed cartridge bearing inserted to offer best performance for both double-pole and classic (alternating arms) technique, minimal maintenance required

- Self-levelling pulley system with robust 6200 sealed cartridge bearings inserted and got width between 62cm / 24.4" (max.) to 26cm / 10.2" (min.)

- Heavy-duty 45cm aluminum fan with cross-bonded steel blades for the ultimate in linear power



SCAN HERE
Assembly Video on
our YouTube channels.

93805

\$ 2.490,00

POLAR
COMPATIBLE

Runner R1
NON-FOLDING

Supperb Rehabilitation Machine

Safe movement with no negative effects



Big LCD screen, with 8 programs and heart rate receiver

4 resistance levels

Ergonomic grips 38mm diameter

Bottle holder

Steel frame 50x150mm

Integrated 75mm casters made of nylon fibers for easy transport

Anti-slip deck, aluminum plates covered with rubber, for comfortable without injuries training

Anti-slip adjustable leveling feet for increased stability

Steel handle for easy portability

SPECIFICATIONS

Dimensions: 188,0x86,0x158,0 cm

Running Surface: 48,0x160,0cm

NET weight: 152 kg

MAX user weight: 150kg

Guarantee: 2 years

Category: F2



TECHNOLOGY

Non-electric treadmill, driven exclusively by the user

Console readings: Time, Distance, Calories, Speed, Watt, RPM of the deck, Heart Rate (optional)

Heart rate measurement with (optional) wireless belt

Power measurement in watt, an accurate measurement to check your progress and improvement

COMFORT

Manually controled 4 level resistance

NO maximum speed

NO waiting when changing speed

Most natural running experience, which relieves tension on the joints

The rubber surface absorbs the harmful for the joints vibrations

CONSTRUCTION

Heavy duty dual anti-slip cast rubber molded slats, with heavy-duty 608zz sealed bearings for proper control of the surface trajectory control

Steel handle on the back for ease of transport

Ergonomic 38mm diameter grips

Anti-slip adjustable leveling feet for ease and stability

93806

\$ 1.840,00

POLAR
COMPATIBLE

HIIT Runner
NON-FOLDING

**A treadmill like
no other...**

Natural resistance exercise machines are the ultimate interval training tools

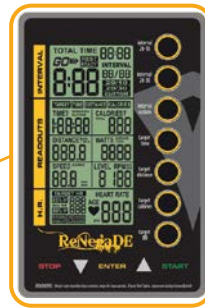

Big LCD screen, with 8 programs and heart rate receiver



2 bottle holders

4 resistance levels

Ergonomic grips 38mm diameter

Oval steel frame 40x120mm

Slats from special PU covered DuPont composite

Integrated 75mm casters made of nylon fibers for easy transport

Anti-slip adjustable leveling feet for increased stability

Steel handle for easy portability

SPECIFICATIONS

Dimensions: 171,0x168,0x99,0 cm

Running Surface: 48,0x160,0 cm

NET weight: 135 Kg

MAX user weight: 150 Kg

Guarantee: 2 years

Category: F2



TECHNOLOGY

Non-electric treadmill, driven exclusively by the user

Console readings: Time, Distance, Calories, Speed, Watt, RPM of the deck, Heart Rate (optional)

Heart rate measurement with (optional) wireless belt

Power measurement in watt, an accurate measurement to check your progress and improvement

COMFORT

Manually controlled 4 level resistance

NO maximum speed

NO waiting when changing speed

Most natural running experience, which relieves tension on the joints

The rubber surface absorbs the harmful for the joints vibrations

CONSTRUCTION

Heavy duty dual anti-slip cast rubber molded slats, with heavy-duty 608zz sealed bearings for proper control of the surface trajectory control

Steel handle on the back for ease of transport

Ergonomic 38mm diameter grips

Anti-slip adjustable leveling feet for ease and stability

93800

\$ 816,00

POLAR
COMPATIBLE

Large LCD screen displays 8 workout modes including 20/30, 20/10, custom intervals, target settings and SPM control

Not an ordinary AIR series!

ReNegaDE machines participate in the most important CrossFit Events and it is no coincidence that they are among the best in the world.

Air Rower

Engineering POM rollers with robust 608zz sealed cartridge bearings



Anti-slip adjustable footstops for more stability

Quick adjust footrests

8 resistance levels

Smooth, natural, unlimited airflow/magnetic resistance from a heavy-duty 37cm aluminum fan

Engineering chromed pulley with robust 608zz sealed cartridge bearings

Nylon fiber integrated OD 74mm moving wheels with 6200 sealed cartridge bearing for easy transportation

SPECIFICATIONS

Dimensions: 218,0x61,5x76,0 cm

NET weight: 49,5 Kg

Gross weight: 58 Kg

MAX user weight: 150 Kg

Frame warranty: Lifetime

Other parts: 2 years

Wear parts: 6 months

Category: F2



TECHNOLOGY

Large LCD screen with a wireless receiver displays all workout data in easy to read format

Tracks time, distance, calories, watts, strokes, SPM and time/500

Target and interval programs

Tracks pulse via optional chest belt

COMFORT

Ergonomic handle with high tensile strength nylon pulling strap

Oversized footplates with adjustable straps to get strong support

The air rower has a comfortable, padded, upholstered seat

Nylon fiber integrated wheels and folding mechanism for easier storage

A fantastic adjustable air resistance that continue challenges you in your exercise

Also supplied with all tools and step by step instructions for easy home assembly

CONSTRUCTION

Engineering chromed pulley with robust 608zz sealed cartridge bearings

SQ 370mm 2.8kg super steel fan

Steel reinforced aluminium track

Engineering POM rollers with robust 608zz sealed cartridge bearings

Thick dual handles with black foam grip

93801

\$ 922,00

POLAR
COMPATIBLE

38mm diameter, 3mm thick moving arms are built to take the most intense upper body workouts

Air Bike Pro

Linear Increase of Intensity and Resistance

In contrast with other types of exercise machines, the ones using air as resistance have the advantage of infinite resistance, suitable for every training level.

Large moulded PU seat for extra comfort, infinitely adjustable quick release saddle adjustment

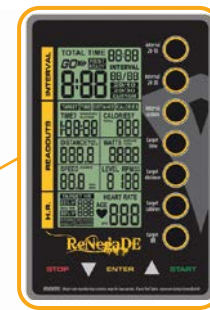

Performance monitor with 8 workouts modes and wireless heart rate receiver

Oversized foot pegs

Main framework constructed from 3mm thick steel for maximum strength

Handle with knurled grip to easily pick up and move it around

Smooth, natural, unlimited airflow resistance provided by a heavy-duty 56cm steel fan with cross-bonded steel blades for the ultimate in linear power

Anti-slip adjustable footstops for more stability

Industrial grade, sealed cartridge bearings on all moving joints for long lasting durability and smooth and quiet action

SPECIFICATIONS

- Dimensions: 123,0x76,5x142,0 cm
- NET weight: 76,5 Kg
- Gross weight: 81 Kg
- MAX user weight: 130 Kg
- Warranty: 2 years
- Category: F2

Low maintenance, endless Poly-V single belt transmission

10 mm Thick SS41 engineering steel crank arm for superb strength & durability

Nylon fiber integrated moving wheels for easy transportation

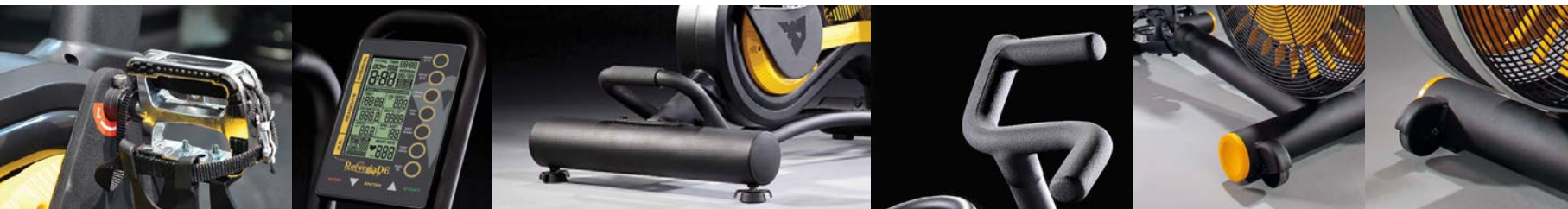

TECHNOLOGY

- Large LCD screen with a wireless receiver displays all workout data in easy to read format
- Tracks time, distance, calories, watts, strokes, SPM and time/500
- Target and interval programs
- Tracks pulse via optional chest belt

COMFORT

- Ergonomic handle with high tensile strength nylon pulling strap
- Oversized footplates with adjustable straps to get strong support
- The air rower has a comfortable, padded, upholstered seat
- Nylon fiber integrated wheels and folding mechanism for easier storage
- A fantastic adjustable air resistance that continue challenges you in your exercise
- Also supplied with all tools and step by step instructions for easy home assembly

CONSTRUCTION

- Engineering chromed pulley with robust 608zz sealed cartridge bearings
- SQ 370mm 2.8kg super steel fan
- Steel reinforced aluminium track
- Engineering POM rollers with robust 608zz sealed cartridge bearings
- Thick dual handles with black foam grip

93811

\$ 735,90



Easy-to-use quick mode buttons with simple control keypad, LCD displays all important information

A comfortable molded seat allows users to work out for longer stretches with maximum enjoyment

Standard, integrated windscreen to prevent blowback for user comfort

Air-driven resistance delivers a simultaneous upper and lower-body challenge allowing the user to emphasize pushing and pulling or experience a total-body workout

Not only allows up and down seat adjustment, but also features a fore/aft adjustment for the perfect fit

Built with extra-heavy-gauge steel tubing to give it a stable base, uses high-quality bearings rather than bushings to ensure a longer life and smoother cycling action

Air Bike AB900 SPIRIT

Standard Integrated Windscreen, Built-in Transportation Wheels

Console: LCD 13x6,5cm, powered by 4xAA batteries

Readings: RPM, Speed, Time, Distance, Calories, Watt, Pulse, Interval prompt

Programs: Target Time, Target Distance, Target Calories, Target HR, Interval 20-10, Interval 10-20, Interval Custom, Manual

Frame: Commercial-grade structural steel with durable powder-coat paint

Flywheel: 27" fan housing with 9 steel blades

Seat: High-density foam racing saddle

Foot Pedals: Large platform, Molded traction pins

Resistance: Unlimited (Air/Based on Fan Speed)

Transmission: Chain, Dual Action, Direct Drive

Weight: 54Kg

Max User Weight: 160Kg

Heart rate: Polar

122x64x127cm

Category
F2

43359

\$ 729,00

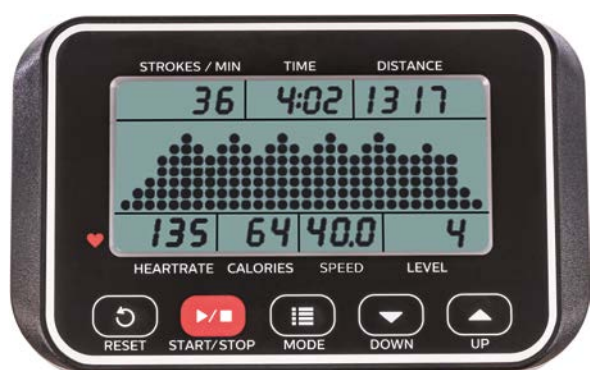

The **CRW800+ Rower** combines a long list of high-performance features with a **reliable design**. From the convenience of the **508mm frame height** and **folding storage design** to the combined **air/magnetic resistance** and **remote handle controls**, the CRW800+ is sure to impress.

It is the perfect addition to a corporate fitness/recreation center, school or hotel because the ease of use and resulting unparalleled full-body workout are second to none.



Wireless remote handle controls allow quick changes to resistance



Flex pedals with easy-adjust numbered settings

Solid steel frame with aluminium monorail



Commercial grade handle strap is both smooth and reliable

Durable stainless steel fan cover

Fold-up frame design for easy storage

CRW800+ Rower **SPIRIT**

Console: LCD 140mm, with adjustable arm and angle, needs 2xC batteries (not included)

Readings: Time, strokes/min, level, distance, calories, watts, pulse

Resistance: Air and magnetic (16 levels)

Flywheel: Ø200mm, 3,5kg

Monorail: 1372mm length

Programs: Manual, Distance, Time, Calories, 20/10 Interval, 10/20 Interval, Custom Interval, Fat Burn, Cardio, Strength, Game

Footrests: Flex pedals with numbered settings

Seat: Contoured and padded

Frame: High-strength steel with durable powder-coated paint, aluminum monorail

Weight: 43,5Kg

Max User Weight: 205Kg

Heart rate: Polar

Unfolded: 239×46×96,5cm

Folded: 135×46×180cm

Category F2

HSR007

\$ 1.136,00



enables users to change the equipment mode from cardiovascular to power training.

SKI & ROW Multiple Training Machine MARS (Magnetic & Air Resistance System) adds a further resistance to the

air resistance. The innovation perfectly solves the problem of no resistance involved at the start position of training,

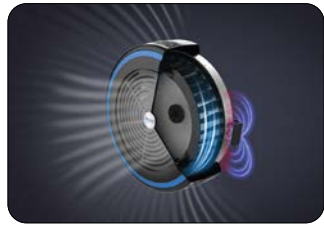

The MARS system has 20 precise resistance levels. Through the console, users can easily adjust the resistance at all times.

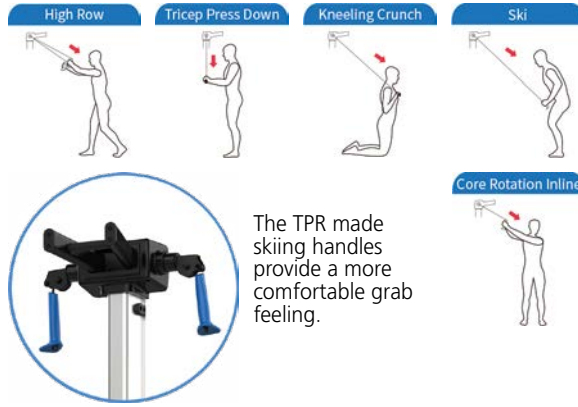

The TPR made skiing handles provide a more comfortable grab feeling.

Thanks to the innovative design, the folded (1,10sq.m.) machine saves 48% space comparing with the rowing (2,12sq.m.) form. Therefore, the SKI & ROW Multiple Training Machine is also suitable for a small fitness studio or residential use.

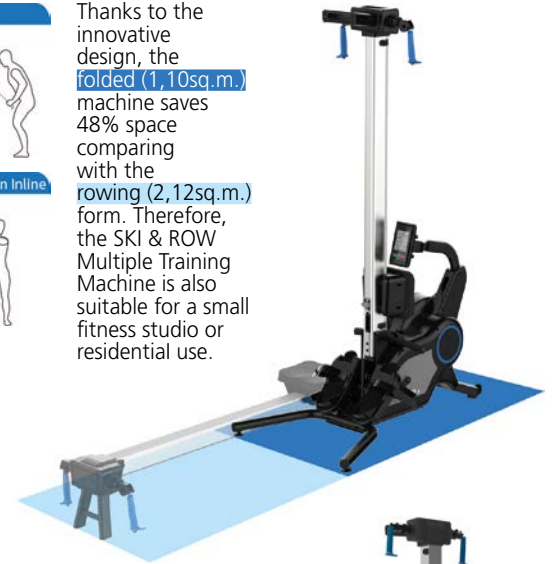

Built-in compatible telemetric heart rate: device helps users to monitor intensity of the workout. The exercise data can be easily synchronized to Wahoo and other third-party Apps via Bluetooth or ANT+. An adjustable console makes it easy to fit better towards user's eyesight and makes it easy to reach from a comfortable position.

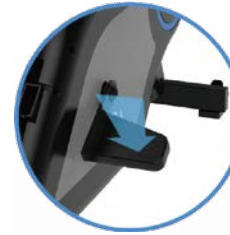

Solid and compact, the specially designed SKI & ROW Multiple Training Machine makes it easy to change from vertical form to horizontal form by simply stepping on the switching pedal. The two-stage air lock system and folding lock-up system ensure safety in daily using condition.



The optional foot straps are ideal for users to train lower body.

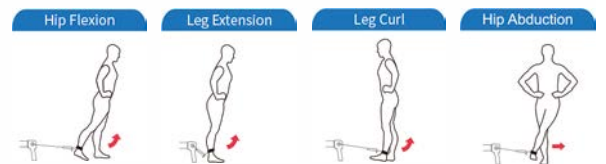

HSR007 Ski & Row

Console: LCD 7", adjustable angle, 8 readout windows (needs 4x C batteries)

Readings: Time, Stroke rate, Pace, Distance, Watts, Calories, Heart rate, Level

Resistance: Air and magnetic (20 levels), power 300W

Flywheel: 4,2kg

Monorail: Aluminum, length 1663mm

Programs: 5 (Time/distance/calorie target, Interval time/distance)

Seat: Contoured, height from ground 51,3cm

Weight: 66,5Kg

Max User Weight: 150Kg

Heart rate: Polar

Folded: 136×88×214cm

292×88×105cm



Max User Weight
150 Kg

Category
F2

HBO05 Ultra Air Bike

HBO05

\$ 799,00

5" LCD console, powered by 4 C cell batteries, with 10 built-in workout modes, including 4 custom HIIT training modes.

Synchronized motion of pedals and handle bars

POLAR

Heart Rate Monitor compatible with Polar heart rate belt

The workout data can be synchronized to your smart devices via Bluetooth or ANT+. Then you can track the data with 3rd party applications which manage your training more scientifically. It helps users make a more reasonable training plan.

The resistance is delivered by the 26" fan, which is driven by power and speed of the pedals along with the two handles that move back and forth. The users are able to determine the intensity level and the resistance.

Consider electropainted steel gets rust easily, the seat support and pedals of ULTRA BIKE are made of aluminum alloy, which is less prone to corrosion, helping provide long service life.

The 26 ABS curved blades, molded into one piece, which makes it stabilized and more quiet than traditional steel blades.



The PU foamed ergonomic seat provides a smooth output and comfortable ride.



Compared to an ordinary air bike with its chain that always sways and bumps and needs scheduled maintenance, Ultra bike's V-Belt drive provides smooth and consistend ride without extra maintenance and high cost.



128×71×133cm

Weight
80 Kg

Max User Weight
150 Kg

Category
F2

Console	LCD 5"
Console Readings	Time, Speed / Average speed, Calories / Average calories, Distance, RPM / Average RPM, Watt / Average Watt, Heart rate / Average Heart rate
Programs	3 Target programs (time, distance, calories), 3 Heart Rate programs (65%, 75% & 85%) and 4 Interval programs (3 time interval and 1 distance interval)
Other Specs	Transport wheels, Cup holder

CT800+

Category F2

44801

\$ 2.270,00



RT750

Category F2

RT750

\$ 2.810,00



Motor	3.00 hp AC (5.50 hp peak)	4.00 hp AC (6.00 hp peak)
Console	7 white LED windows, Speed and Incline buttons, Heart rate sensors	16x32 Dot Matrix + 7 Led Windows, Single-key program selection, Numeric keypad, Speed and Incline buttons on the hand-grips , Heart-rate sensors
Console Readings	Time (elapsed and remaining), Distance, Heart rate, Calories, Speed, Incline, Pace, Track, Watt, METs	Time, Remaining time (%), Distance, Calories, Calories/hour, Speed, Average Speed, Incline, Steps, Pace, Heart rate, Heart rate (%), Time in target zone
Programs	7 + 2 HRC + 6 fitness tests + custom + manual	6
Speed	0.8-20 Km/h	0.6-25 Km/h
Incline	Electronic 15 levels, 0.5 increments	Electronic 0-15%
Deck	Maintenance-free, 25mm, double-sided	Reversible 2,54 cm
Belt	56x152,5 cm Habasit	56x152 cm, 24,5 cm over the ground, Habasit prewaxed, 1,6mm
Rollers	75mm	Front 89mm, Rear 75mm
Dimensions (open)	215,9x90,9x153,9cm	208x95x159 cm
Weight	173Kg	207Kg
Max User Weight	205 Kg	180 Kg
Other Specs	Fan, Phone/tablet holder, Bottle holder, USB charging, Accessory tray, Polar	Cell/I-pad stand, Fan, Transport wheels, 2 bottle holders, Book stand, Polar

SPIRIT

NON-FOLDING

Semi-Commercial Grade

USAGE WITH PHONE

+ Bluetooth FTMS 4.0

- Motor protected against overheating and peak overload
- Polar compatible
- Power control board with cooling system
- Deck: DK Ultimate Deck (manufacturer by D&P, USA) with increased service life, the standard of comfort, reliability and durability



WARRANTY

1 year for commercial use

- Belt: Commercial, multi-layer Habasit (Switzerland), one of the strongest and most durable cloths in the world; Two rubber layers for durability, a PVC layer to prevent excessive stretching and a nylon fabric layer for good sliding on the deck



inimpulse

NON-FOLDING

Commercial Grade

RT750B

\$ 2.810,00

Also available in black color





- **Inverter:** Delta
- **Suspension:** Pulflex
- **Maintenance:** Not needed for approximately 40,000 km.

WARRANTY

1 year for commercial use

+ Speed & Incline buttons on the hand-grips



	TA-7715	Category F2	44780 \$ 2.450,00	 TAIWAN	AC2990	Category F2	AC2990 \$ 1.599,00	 CHINA
Motor	3.00 hp AC (6 hp peak)				AC 3.00 hp (4.50hp peak)			
Console	Dot Matrix LED 21x10 + 6 Windows, Speed and Incline buttons, Heart rate sensors				Dot Matrix 8x16, 6 LED windows, Speed and Incline buttons, Heart rate sensors			
Console Readings	Time, Speed, Distance, Heart rate, Calories, Incline				Time, Avg. Speed, Heart rate, Distance, Steps, Calories, Cal/Hour, Speed, Incline			
Programs	4 predefined + 1 manual + 1 user + 1 HRC				3 target + 5 preset + manual + 2 user + 3 HRC			
Speed	0.8-25 Km/h				1-20 Km/h			
Incline	Electronic 0%-15%				Ηλεκτρική, 0%-15%			
Deck	Shock resistant laminated double sided MDF with melamine 25,4mm, with absorbent antivibration elastomers on the bottom				Reversible, 25mm thick			
Belt	56x158 cm, thickness 3,3mm, PVC 4 layers				Siepling, 56x152 cm, 2.3mm thick			
Rollers	Front 89mm, Rear 89mm				Front 76,5mm, Rear 76,5mm			
Dimensions (open)	218x100x150 cm				220x92x156 cm			
Weight	219Kg				170Kg			
Max User Weight	180 Kg				150 Kg			
Other Specs	Transport wheels, Bottle holder, Book holder, Handrail of double injection PVC				Phone holder, 2 bottle holders, Transport wheels			



NON-FOLDING

Commercial Grade



• Hybrid suspension for smooth shock absorption and to prevent from injury during the exercise

WARRANTY
1 year for commercial use



NON-FOLDING

Commercial Grade



WARRANTY
1 year for commercial use



43334

\$ 1.512,00



Semi-Commercial Grade



Step length can be adjusted from 46cm to 61cm, electronically adjustable with a button on the right handle.



213x82x177cm

Category F2

CE 850 SPIRIT

Computer: Blue Dot Matrix, 20 character message window, heart-rate bar graph, one-touch program selection, fan, tablet stand, tray

Readings: Time, Distance, Calories, Speed, Reps/min, Watt, Heart rate

Programs: 5 predefined + 1 manual + 2 user + 2 HRC

Resistance: 20 levels (electronically adjusted)

Frame: Steel powdercoated

Disk: 13.5 Kgr

Pedals: Big size, 5 cm apart, 2 degree inversion, placing the user in an anatomically correct position

Grips: Adjustable in many positions, resistance and step buttons

Weight: 120Kg

Step: 457-609mm

Max User Weight: 150Kg

Heart rate: Touch and with optional heart-rate belt

43394

\$ 1.450,00



Semi-Commercial Grade



CE 800+ SPIRIT GENERATOR

Computer: Large multi LED windows, 18 character message center, track and profile window, adjustable fan angle, tablet stand, bottle and accessory holder, USB charging port

Readings: Time (elapsed and remaining), Distance, Calories, Speed, Reps, Watt, Heart rate, Level, METs, Track, Profile

Programs: 5 predefined + Manual + Custom + HRC + Fitness test + Constant power, METs

Resistance: 40 levels (electronically adjusted)

Frame: Steel powdercoated

Disk: 14 Kgr

Stride: 50,8mm

Pedals: Big size, 2 degree inversion, placing the user in an anatomically correct position

Weight: 110Kg

Max User Weight: 205Kg

Heart rate: Touch and with optional heart-rate belt



198x63,5x178cm

Category F2

RE700

\$ 1.705,00

Commercial Grade



CHINA

RE700B

\$ 1.705,00

Also available in black color



Function control

On the stable handgrips, for ease of use

Self-powered

No plug required, it generates its own energy during use

Natural motion

Featuring a 53 cm stride length and rear-drive design for smoother, flatter motion



Commercial Grade

Built for heavy commercial abuse, with a max user weight of 160 kg and a powder-coated, rust-resistant frame

Comfort

With a narrow pedal spacing (2,54 cm), gel-cushioned pedals 19 cm from the ground and multi-position ergonomic handles

RE700 inimpulse

Transport wheels, Bottle holder, Towel hanger

Computer: Dot Matrix + 6 Windows, Single-press program selection, Numeric keypad

Readings: Time, Distance, Calories, Resistance, Steps, Heart rate

Programs: 7 predefined

Frame: 2 layers of paint over anti-rust layer

Resistance: 25 levels (electronically adjusted)

Brake: Self-powered hybrid break, 350W resistance

Step: 53cm

Handgrips: Movable: Ergonomic, Εργονομικές, multi-position, dual energy
Stable: Ergonomic, with heart rate sensors and function control

Pedals: With gel pillows, distanced at 2,54 cm, 19 cm from the ground

Weight: 118Kg

Max User Weight: 160Kg

Heart rate: Polar & Touch

218x74x161cm



43366

\$ 1.174,00



Semi-Commercial Grade



CE

151x74x129cm

Category F2

CR 800+ SPIRIT GENERATOR

Computer: Large multi LED windows, 18 character message center, track and profile window, adjustable fan angle, tablet stand, bottle and accessory holder, USB charging port

Programs: 5 predefined + Manual + Custom + 2 HRC + Fitness test + Constant power

Disk: 14 Kgr

Resistance: 40 levels (electronically adjusted)

Drive train: Poly-V belt with self-tensioner

Frame: Steel powdercoated

Seat: 14 positions, aluminum rail

Pedals: Oversized with fast-latching adjustable strap system

Weight: 74Kg

Max User Weight: 205Kg

Heart rate: Touch and with optional heart-rate belt

43369

\$ 1.685,00



Commercial Grade



CE

170x74x125cm

Category F2

CR 900 SPIRIT GENERATOR

Transport wheels, 42mm bearings, 3 speed fan, Book/tablet rack, Shelf

Computer: LED backlight, 18 character message window, laps, hear-rate bar graph, separate screens for reps and level, keypad, bottle holder

Programs: 7 + 1 manual + 2 HRC

Disk: 14 Kgr

Bearings: IKO, NACHI, INA/SKF

Resistance: 40 levels

Gear ratio: 9.5:1

Frame: Steel powdercoated

Console: Corestar

Seat: Infinite adjustments

Pedals: Big, weighted

Weight: 88Kg

Max User Weight: 160Kg

Heart rate: Polar & Touch

RR500

\$ 1.093,00

Semi-Commercial Grade



CHINA

RR500B

\$ 1.093,00

Also available in black color



165x65x140cm



RR500

Bottle holder, Transport wheels

Computer: Dot Matrix + 7 Windows, program selection with the press of a button, Numeric keypad

Readings: Time, Distance, Watt, Speed, Calories, RPM, Heart rate

Programs: 11

Frame: 2 layers of paint over anti-rust layer

Grips: Ergonomic, with hear-rate sensors and function control

Resistance: 20 levels (electronically adjusted)

Brake: Self-powered hybrid brake, 300W resistance

Crank: Standard

Pedals: Single-sided weighted

Max User Weight: 160Kg

Weight: 79Kg

Heart rate: Polar & Touch

RR700

\$ 1.265,00

Commercial Grade



CHINA

RR700B

\$ 1.265,00

Also available in black color



165x64x138cm



RR700

Bottle holder, Transport wheels

Computer: Dot Matrix + 6 Windows, program selection with the press of a button, Numeric keypad

Readings: Time, Distance, Watt, Speed, Calories, Heart rate

Programs: 7

Frame: 2 layers of paint over anti-rust layer

Grips: Ergonomic, with hear-rate sensors and function control

Resistance: 25 levels (electronically adjusted)

Brake: Self-powered hybrid brake, 350W resistance

Crank: Oversized

Pedals: Oversized double-sided with straps

Max User Weight: 180Kg

Weight: 83Kg

Heart rate: Polar & Touch

RU500

\$ 958,00

Semi-Commercial Grade



CHINA

RU500B

\$ 958,00

Also available in black color



RU500

Bottle holder, Transport wheels

Computer: Dot Matrix + 7 Windows, single-press program selection

Readings: Time, Distance, Calories, Speed, Incline, Steps, Heart rate

Programs: 11 predefined

Frame: 2 layers of paint over anti-rust layer

Hand-grips: 3-position adjustable, with heart-rate sensors and function buttons

Resistance: 20 levels (electronically adjusted)

Brake: Self-powered hybrid brake, 300W resistance

Crank: Standard

Pedals: Single-sided weighted

Max User Weight: 160Kg

Weight: 68Kg

Heart rate: Polar & Touch



109×66×149cm



RU700

\$ 1.115,00

Commercial Grade



CHINA

RU700B

\$ 1.115,00

Also available in black color



RU700

Bottle holder, Transport wheels

Computer: Dot Matrix + 6 Windows, single-press program selection

Readings: Time, Distance, Calories, Speed, Incline, Steps, Heart rate

Programs: 7 predefined

Frame: 2 layers of paint over anti-rust layer

Grips: 3-position adjustable, with heart-rate sensors and function buttons

Resistance: 25 levels (electronically adjusted)

Brake: Self-powered hybrid brake, 350W resistance

Crank: Oversized

Pedals: Oversized double-sided with straps

Max User Weight: 180Kg

Weight: 67Kg

Heart rate: Polar & Touch

Handgrips
With
function
buttons



109×60×149cm



PS460
\$ 890,00



CHINA

Commercial Grade



The console is powered by the bike's self-generated electricity and supports Bluetooth protocols, allowing it to connect with the majority of third-party apps available in the market.

Dual cup holders for intense training

Magnetic brake system provides more stable resistance, and more convenient adjustment.

V structure, 164mm Q-FACTOR allows ideal riding position.

Dual-sided pedals allow riders to wear either cycling or athletic shoes

Larger main frame, over-sized axis and pedal shaft ensure reliable quality

Tension unit for stretch before and after riding.

Seat and handles are adjustable horizontally and vertically. Aluminum post and newly designed knob allows convenient adjustment.

Rear aluminum flywheel is waterproof. The plastic edge shroud ensures riding safety. Maintenance-free belt offers more quiet and smoothly riding experience.

PS460

Two (2) bottle holders, Transport wheels, Emergency brake

- Computer:** Bluetooth compatible 4,3" LCD
- Readings:** Resistance level, Time, Speed, Distance, Watt, RPM, Heart rate, Calories
- Resistance:** Magnetic, 20 levels
- Brake:** Self-powered 400W resistance
- Transmission:** Belt
- Ratio:** 1:10
- Frame:** Steel
- Shaft:** Ø25 with TPI bearings
- Pedals:** Double-sided
- Seat:** Ultra-padded sport saddle, adjustable vertical/horizontal
- Handlebar:** Multi-position, Soft PVC, adjustable vertical/horizontal
- Flywheel:** Aluminum 3,5kg
- Pulley:** Aluminum
- Weight:** 50,3Kg
- Max User Weight:** 150Kg

PS460B

\$ 890,00

Also available in black color



PS450

\$ 801,00

PS450
Computer: Without



Find the computer on the next page

PS450B

\$ 801,00

Also available in black color



132x60,5x106cm



PS300B

\$ 550,00

Commercial Grade



CHINA

PS300

\$ 550,00

Also available in silver color



Side brake, allowing you to adjust the resistance more smoothly and evenly

Spline fit axis, which has better loosening prevention function

PS300

Bottle holder, Transport wheels, Emergency brake

Computer: Wireless LCD 4,7" (optional component, see below)

Transmission: Chain

Pedals: SPD double-sided

Seat: Microadjustable

Grips: Rubber coated

Disk: 20kg

Weight: 58Kg

Max User Weight: 150Kg

119x53x117cm **RoHS**

PS300DZB

\$ 36,00



PS300DZB

Type: LCD

Dimensions: 4.7"

Power supply: From the bike's generator

Readings: Resistance Level, Time, Speed (AVG/MAX), Distance, Watt (AVG/MAX), RPM (AVG/MAX), Heart Rate (AVG/MAX), Calories

XSC700

\$ 2.590,00



CHINA

Commercial Grade

The central control handle is equipped with a hand-held HRM, speed adjustment buttons on the right side, and an emergency stop button on the left side, allowing you to control the speed and your safety at any time

The ergonomic design of quick adjustment knob increases the convenience and comfort of adjustment while training

Pedals made of PP to reduce the noise during use

The extended armrest with TPU coating can enhance the user's comfort

Transmission utilizing chain and wedge-shaped belt to reduce noise and sustain the transmission power

The two-stage transmission utilizes a wide range of step adjustment

The magnetic resistance mechanism is placed on the side for easy maintenance

Ergonomic design of 202mm step-up height

Equipped with moving wheels for ease of moving

Equipped with infrared sensor switch to provide double protection

Automatic brake function when power is off to ensure safety

The chain gear adopts the expansion sleeve, which is convenient for installation, adjustment and maintenance

Foot pedals on both sides for ease of use

XSC700 in impulse

Transport wheels, Cup holder, Magazine holder, Phone holder

Computer: LED + Dot matrix

Readings: Time, Steps, Calories, Speed, heart rate, Gear level

Programs: Default: Quick Start, Climbing 1-5, Interval 1-5, Target: Time, Distance, Calories
HRC: Target HR, Interval HR
Custom: Distance, Climbing, Interval

Resistance: 20 levels, plug-in magnetic

Charging: Smartphone (wirelessly)

Brake: 700W

Speed: 25-158 steps/min

Step: L559xW254xH202mm

Weight: 206,4Kg

Max User Weight: 160Kg

Heart rate: Touch and with optional heart-rate belt

142x93x225cm



3D DESIGN

ECDESIGN



ECONOMY | INNOVATION | DEVELOPMENT

Save cost and time by reducing the interventions that arise after completing the project.

Visualise your gym complete and perform a virtual walk through it using a video tour, even before the first crew begins working!

3D design is not a fad or just one more technology. It is the evolution in construction.



Our team expands. The sales consultants, in collaboration with the permanent specialized new-technologies team of the company, now offer a package consisting of selecting, designing and photorealistically visualising, that can work individually or in tandem with the architect's plans.

We at EΛΔΙΚΟ integrated a comprehensive program of services including consulting design, to create a functional professional environment and 3D visualizations of the space, according to the need to be served and the unique aesthetic that suit you.



We integrate the floor-plan in collaboration with the architect



We configure the gym according to your needs, maximizing its functionality



We turn drawings to 3D presentations



We export the list of the selected machines to a file

HSP-PRO-001

\$ 2.424,00

HSP-PRO-001

Air Resistance Dual-Arm Functional Trainer

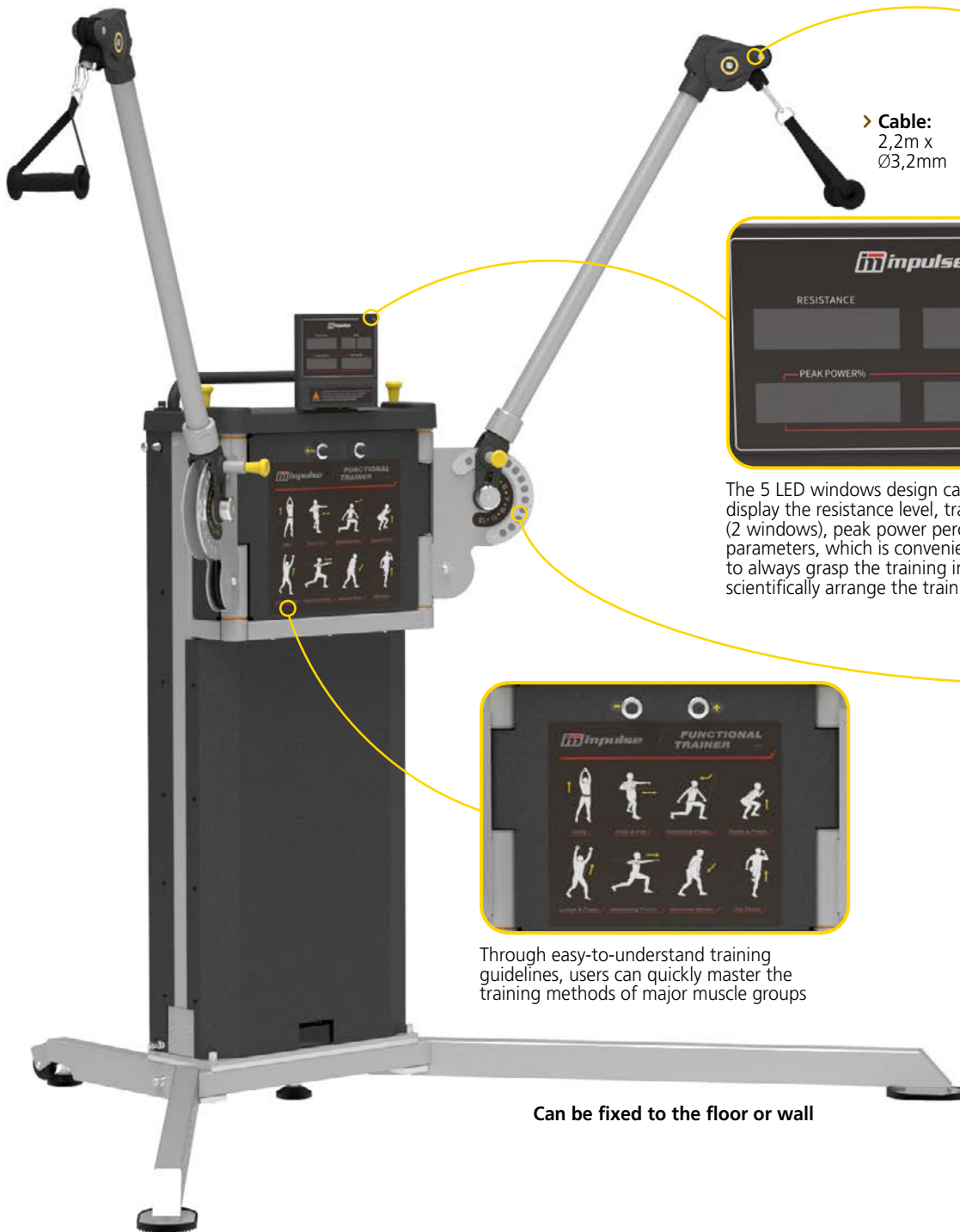

> **Cable:**
2,2m x
Ø3,2mm

Equipped with double training arms, the cable joint end can rotate 360° with the change of force direction of the trainer, ensuring the comfort of the strength exertion and variable force direction need during the training process. Meanwhile, it can protect the cable and extend its service life

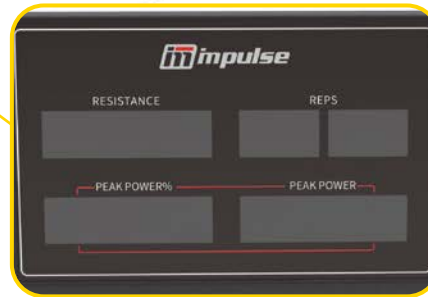

It can also expand a variety of accessories to cooperate with various special functional trainings, such as dual pull handle, ankle strap, training bat, training belt, thigh strap, tricep training rope, etc

The 5 LED windows design can accurately display the resistance level, training times (2 windows), peak power percentage and parameters, which is convenient for the user to always grasp the training information to scientifically arrange the training plan



Through easy-to-understand training guidelines, users can quickly master the training methods of major muscle groups



Depending on the height and movement of the trainer, the training arm can be adjusted in coronal plane (up/down) of 180° and at 13 gears. Unilateral horizontal level of both arms (front/rear) 90°, 7 gears adjustment, which is suitable for all heights and training types

Can be fixed to the floor or wall

Air resistance training equipment is necessary in today's top professional fitness training and explosive force training equipment, based on professional competitive market, our company combined with 27 years of strength series product development experience, after three years of research and development, introduced the HSP - PRO001 Air Resistance Dual-Arm Functional Trainer to make up the blank of domestic products in this area.

At present, competitive sports are popular all over the world, and tens of thousands of sports fans are constantly participating in their favorite competitive sports. This gave birth to the training concept of physical training, sports performance training and sports rehabilitation. In this field, air resistance strength equipment is widely used. You will find air resistance strength training equipment in the NBA/NFL and various top league competition centers.

In this field, a combination of strength and speed training is required, and traditional iron counterweight strength equipment cannot satisfy the combination of strength and speed training. Impulse intends to transport strength equipment that could only be used in top competitions in the past to the mass fitness field, and construct safer strength training equipment, so that mass fitness enthusiasts who love sports can also carry out training that combines speed and strength, fully explore the potential of mass fitness, and allow trainers to create a more powerful body model, which is also what mass fitness enthusiasts need.

Resistance	Increment	Levels	Weight	Category
2-25Kg	0,1Kg	25	150Kg	F2

250×110×240cm

94470

\$ 29,87

- > **Material:** 100% primary rubber
- > **Dimensions:** 1 x 1 m, 1,5cm thick
- > **Connectivity:** Can be securely connected either as a big surface using connectors at the corners, or many pieces in a straight line using connectors only on the sides.



Upper surface



Lower surface



Lower connector



Upper connector

Rubber Flooring

Category F2

9447001

\$ 6,22

- > **Dimensions:** 0,5x0,2 m, 1,5cm thick
- > Slanted side to protect the flooring's edges

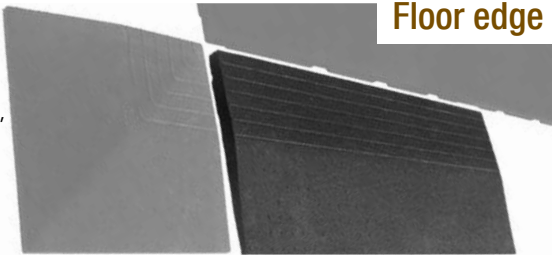

Floor edge

9447002

\$ 3,09

- > **Dimensions:** 0,2x0,2 m, 1,5cm thick
- > Slanted corner to protect the flooring's edges

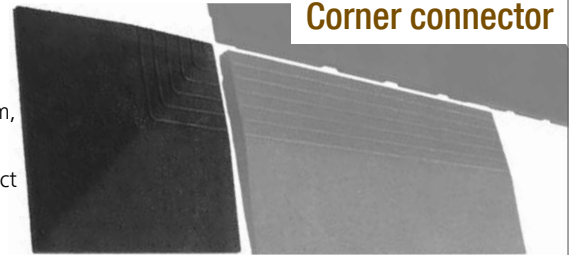

Corner connector

94472

\$ 29,11

- > **Dots:** Gray
- + The gray dots are like EPDM and help disguise footprints
- + Expected service life 4-7 years
- Choice between blue, light-blue and yellow dots

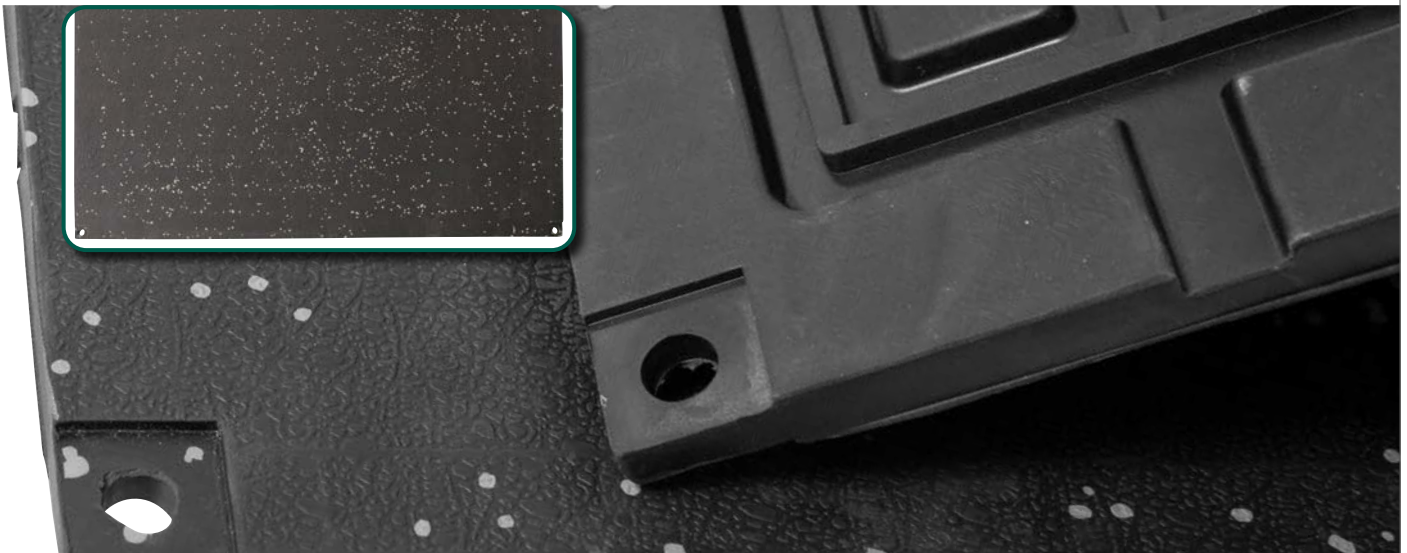

Category F2



Connectors

The tiles are fixed together using connectors hidden at the bottom

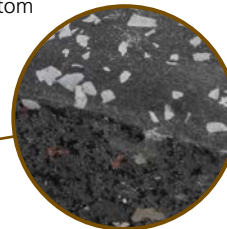

Layers

The top layer, 1.5mm thick, consists of SBR and EPDM in white color. In the bottom layer, the EPDM is of random color.

Floor from Recycled Rubber

CODE	PRICE	MATERIAL	DIMENSIONS	THICK	SHAPE	COLOR	DENSITY	WEIGHT
94491	\$ 27,60	SBR 70%, EPDM 30%	100x100cm	20mm	Tile		900 kg/m ³	18,00 kg/pc
94492	\$ 7,50		100x50cm					4,50 kg/pc
94493	\$ 26,60	SBR 80%, EPDM 20%	100x100cm					18,00 kg/pc
94494	\$ 7,25		100x50cm					4,50 kg/pc

CLEANING AND MAINTENANCE GUIDE

Cleaning your rubber flooring is imperative to avoid odors and concentration of dirt. The frequency depends on how often the space is used, and the manner in which it is used. Clean water and a cotton (or microfiber) mop are sufficient to keep the rubber flooring in good condition. Avoid using detergent and do not allow any water puddles to form, especially in between tiles and seams.

Despite the fact that rubber flooring is quite durable, if not regularly cleaned, apart from the aesthetic aspect, it can lose some of its properties and be permanently damaged. Please remember that, despite its durability, rubber flooring cannot be considered a hard surface. On the contrary, it is among the soft surfaces.

Recycled rubber flooring is made of moulded rubber granules. From time-to-time, a small quantity of these granules may be released and found either on the floor surface or close to its borders. Such granules are considered normal wearing of the recycled rubber flooring, and they can be removed just by vacuuming.

Keep in mind that rubber flooring is one of the disposable materials for a Gym, especially for heavy traffic ones. It will get worn down over time. A gradual wearing of the original matte color is considered totally normal with this type of flooring. When the flooring contains EPDM granules on the surface, colour fading will naturally occur.

Whether it is rolls or tiles, please follow these basic recommendations for correct cleaning and maintenance.

PREVENTIVE MEASURES: It is very important to avoid damage from very hard shoe soles or even pebbles stuck to the soles of the shoes. We recommend that you adopt the use of a shoe cleaning and storage area next to the entrance. It's imperative to start the cleaning process by vacuuming the surface of the rubber flooring. Dust and small debris can become abrasive if picked up and dragged across the surface.

CLEANING PROCESS: A Avoid any cleaning products or chemicals that are too acidic or alkaline, as they will damage the surface of the rubber flooring. Do not use products containing turpentine or other solvents. On the whole, please refrain from using any chemical products based on petroleum, solvents or chlorine. Whichever cleaning product you decide to use should be of strictly natural origin. Please make sure that any mats, carpets, buckets or other items that will be placed on the flooring are suitable for use on rubber flooring.

REGULAR CLEANING:

1. Clean all surface residues and dirt by vacuuming with a suitable vacuum on low setting and a very soft bristle.
2. Mop the area using clean water (water temperature between 15-20°C), using a sufficiently wrung cotton string or microfiber mop; avoid using too much water.
3. Rinse once again using clean water and a well-wrung mop. Make sure you wipe the surface well, removing all water. Flooding the surface will allow water to stay longer, resulting in undesired odors. Using clean water is imperative.
4. Let it dry (2-3 hours) before stepping on it.

CAUTION! Do not use any scrubbing machines or similar mechanical methods. Permanent damage will occur.



Floor from Recycled Rubber

- > **Width:** 1,2m
- > **Length:** 10m
- > **Shape:** Roll

- > **Specs:** Tough elastic, high compression resistance and impact strength, skid and spike resistant, non-slip, high abrasion resistance, comfortable and noise insulating.

Category F2

CODE	PRICE	MATERIAL	THICKNESS	COLOR	DENSITY	WEIGHT
94460	\$ 132,00	SBR	6mm	Black	990-1020 kg/m ³	5,9-6,1kg/m ²
94461	\$ 168,20		8mm			7,8-8,2kg/m ²
94463	\$ 199,90		10mm			9,8-10,2kg/m ²

CODE	PRICE	MATERIAL	THICKNESS	COLOR	DENSITY	WEIGHT
94464	\$ 174,50	SBR & EPDM	6mm	Blue	980-1020 kg/m ³	5,9-6,1kg/m ²
94466	\$ 177,20			Yellow		
94465	\$ 206,90		Blue	8mm		7,8-8,2kg/m ²
94469	\$ 208,90		Yellow			

More flake colors available upon request



94455-94457 - Upper surface



94455-94457 - Lower surface

Floor from Recycled Rubber



94451 & 94453



94454

CODE	PRICE	SURFACE	DIMENSIONS	THICK	SHAPE	COLOR	DENSITY	WEIGHT
94451	\$ 11,00	Smooth	100x50cm	15mm*	Tile	Black	850 kg/m ³	6,75 kg/pc
94453	\$ 11,90			20mm		Black		9,00 kg/pc
94454	\$ 13,40			15mm*		Grey		13,50 kg/pc
94455	\$ 23,20		100x100cm	20mm		Black		18,00kg/pc
94456	\$ 28,00					Grey		
						Black		

Constructed using a different process, its thickness is almost EXACTLY the stated above, offering a perfect fit after installation. At the same time, the smell emitted from the flooring is infinitesimal.

* 1 year warranty for code #94451 due to small thickness, 2 years for a thickness of 20mm.

Category F2

- > **Material:** Recycled rubber



BeGreen Active

Indoor use

Synthetic rubber tiles combined with very thin strands of artificial turf. Similar to BeGreen Astro tiles, but the thinner strands, although offering a magnificently soft feel, have the disadvantage of not being able to be used with heavy sleds due to the fact that they will tear.

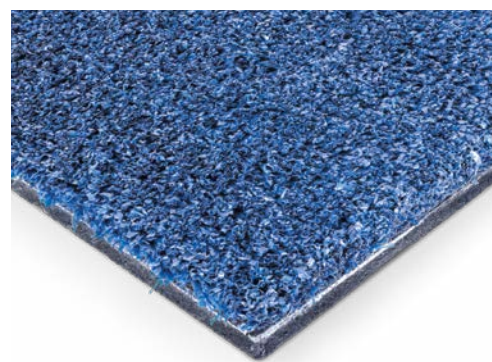

BeGreen Astro

Indoor use

BeGreen Astro floor brings together a superb combination: the aesthetic result provided by artificial turf with the soft feeling of a rubber tile.

They have been designed for indoor use. They can be used in multi-functional areas in sports fields and gyms.



- > **Base:** Recycled SBR Rubber
- > **Fibers:** 100% PE, density 300 micron, length 20 mm, Monofilament 9.000 / 6 DTEX (±5%)

CODE	PRICE	DIMENSIONS	COLOR	THICKNESS	SHAPE
94475	\$ 43,80	98x98cm	Green	20mm	Tile

Category F2

- > **Base:** Recycled SBR Rubber
- > **Fibers:** 100% PE, density 100 micron, length 20 mm, Monofilament 11.000 / 1 DTEX (±5%)

CODE	PRICE	DIMENSIONS	COLOR	THICKNESS	SHAPE
94476	\$ 45,20	98x98cm	Green	20mm	Tile
94473	\$ 27,50		Blue		

Weight 24kg

Category F2

- > Make your Gym different with our Sprint track. Designed and manufactured to offer higher performance, its polyamide yarn (instead of PE) will offer you a solution for the track you need.
- > With the standard design, it is easy to do many types of exercises and it is perfect for long term indoor use.

Sprint Track

- > **Fibers:** 100% Polyamide coated with SBR latex, length 10 mm
- > **Weight:** 2.250gr/m²

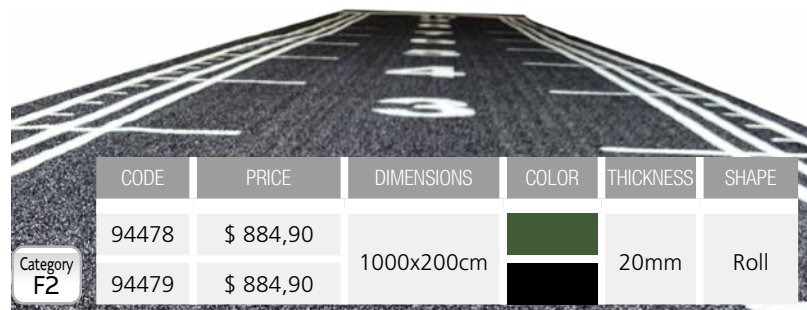

CODE	PRICE	DIMENSIONS	COLOR	THICKNESS	SHAPE
94478	\$ 884,90	1000x200cm	Green	20mm	Roll
94479	\$ 884,90		Black		

Category F2

94480

\$ 884,90

"Game" Sprint Track

Have some fun during high performance exercises

- >> **Fibers:** 100% Polyamide coated with SBR latex, length 10 mm
- >> **Weight:** 2.250gr/m²
- >> **Use:** Indoor



SPECS

Dimensions: 1000x200 cm
 Thickness: 20 mm
 Shape: Roll
 Category: F2

Wall Stickers

Protects, insulates and beautifies the wall

- + Made of environmentally friendly, non-toxic material, absolutely safe for children.
- + Waterproof, easing the cleaning process.
- + It can be placed on almost any type of surface, as long as it is smooth (e.g. wood, plastic, metal, tile, glass, wallpaper), since it is equipped with a strong adhesive on the back side.

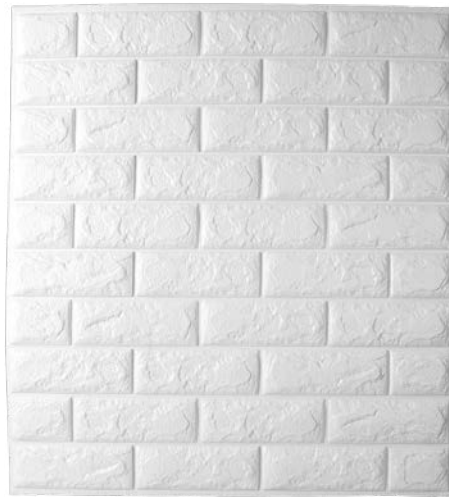

- > **Material:** Foam
- > **Dimensions:** 77x77x1cm

CODE	PRICE	COLOR
36650	\$ 3,25	

Weight
280gr

Category
F1

XZ5001

\$ 76,90



Category
Φ2

Rings

XZ5002

\$ 99,50

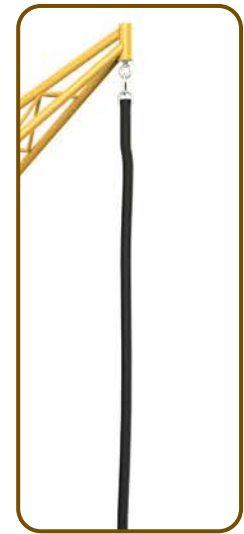

Category
Φ2

Climbing Rope

46640

\$ 1.050,00

- Practice angle for an effective contraction of the gluteus.
- Adjustable chest pad adapted to users of all sizes
- Grab handles and pads for forearms ensures a stable exercise position.



Weight
280 Kg

PL Weights
110 Kg

Category
F2

214,5×130×152,8cm

Glute Isolator

E7024

46641

\$ 1.050,00

- With the adjustable back cushion, the user can easily find the correct position in relation to the axis of rotation.



Weight
260 Kg

PL Weights
110 Kg

Category
F2

128,5×105,5×152,8cm

Back Extension

E7031

- Two different height footrests adapt to different user sizes.
- The special design allows natural movements for excellent muscle contraction.
- The adjustable starting mechanism can be adjusted to the desired movement radius.

M90T

Category F2

44894
\$ 2.450,00



M905T

Category F2

44893
\$ 2.250,00



Motor	3.00 hp AC (6 hp peak)	3.00 hp AC (6 hp peak)
Console	Dot Matrix 16x32, 128x64mm, Heart rate sensors	Dot Matrix 16x16, 64x64mm, Heart-rate sensors
Console Readings	Speed, Time, Remaining time, Distance, Heart rate, Calories, Incline, Pace (min/km)	Time, Distance, Calories, Speed, Heart rate, Incline, Pace (min/km)
Programs	10 predefined + 2 heart rate + 10 user + 3 target	6 predefined
Speed	0.1-18 Km/h	0.1-18 Km/h
Incline	Electronic 0-15%, 30 levels	Electronic 0-15% 30 levels
Deck	Waxed	61x138cm
Belt	51x152 cm	52x152 cm
Rollers	Front 154x676mm, Ø88,5, Back 560mm, Ø88,5	Front 154x676mm, Ø88.5, Rear 560mm, Ø88.5
Dimensions (open)	212x85x134 cm	221x85x134 cm
Weight	195Kg	190Kg
Max User Weight	185 Kg	160 Kg
Other Specs	Bottle holder, Tray	Bottle holder, Tray

NON-FOLDING
Commercial Grade



NON-FOLDING
Semi-Commercial Grade



MOTOR HITACHI
ELECTRONICS and MPU INVERTER HYUNDAI



CE

CE





Your Wellness Solution Provider

Impulse Health Tech Co. Ltd is a pioneering designer and manufacturer of Fitness equipment.

Its experience manufacturing strength and cardio fitness machines exceeds 35 years, while for over 18 years has been manufacturing the machines of the largest Fitness brands worldwide.

It's R&D department consists of more than 40 electrical engineers and mechanical engineers, working hard to meet the needs of the modern world of Fitness.

Its experience manufacturing strength and cardio fitness machines exceeds 35 years, while for over 18 years has been manufacturing the machines of the largest Fitness brands worldwide.

It's R&D department consists of more than 40 electrical engineers and mechanical engineers, working hard to meet the needs of the modern world of Fitness.

Why should I choose Impulse?

- 35 years of experience in equipment manufacturing
- Key manufacturer of many world-renowned brands
- Offering complete packages at competitive prices
- High quality of raw materials
- Designed by leading engineers
- Thousands of gyms around the world trust Impulse
- The very good service of the Greek dealership





I-zone Line

The Functional Training Zones by Impulse provide customizable and flexible solutions for CrossFit or working out with functional cages. It is paramount for it to be present in your gym and used for group training. The combinations of the series that can be constructed, plus the additional accessories, include: stretching, boxing, rebounder, step, dips and racks.

Whether you're a CrossFitter, or a plyometrics fanatic, or you just want to add some general usage exercises in your program, the I-Zone range has you covered. Take the medicine balls, kettlebells, speed/agility gear or strongman style equipment and raise your training to another level!



Learn more about I-Zone line
and the possible combinations at
www.amila.gr scan the QR-code



IZ-X Shape

IZ-X Shape

\$ 6.024,00

» Includes:

- IZ7002
- IZ7003
- IZ7004
- IZ7005
- IZ7006
- IZ7007 (x2)

» Any other pictured product, other than those listed above, is not included.

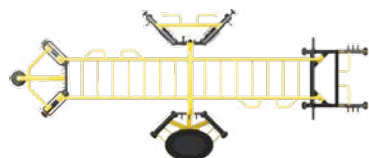

SPECIFICATIONS

Dimensions: 749x314x245 cm

NET weight: 928,5 kg

Category: F2

IZ-H Shape

\$ 5.453,00

» Includes:

- IZ7001
- IZ7002
- IZ7003
- IZ7005
- IZ7015

» Any other pictured product, other than those listed above, is not included.

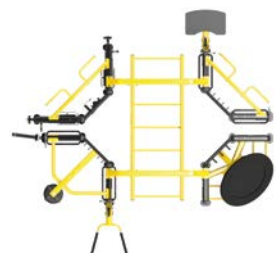

IZ-O Shape

\$ 5.569,00

» Includes:

- IZ7001
- IZ7002
- IZ7003
- IZ7005
- Z7014

IZ-H / IZ-O Shape



SPECIFICATIONS

Dimensions: 414x288x245 cm

NET weight: 833,6 kg

Category: F2

IZ-L Shape

IZ-L Shape

\$ 3.177,40

» Includes:

- IZ7001
- IZ7002
- IZ7003
- IZ7008
- IZ7011

» Any other pictured product, other than those listed above, is not included.

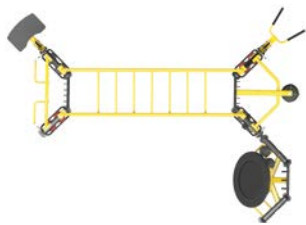

SPECIFICATIONS

Dimensions: 480x325x245 cm
 NET weight: 462,6 kg
 Category: F2

IZ-T Shape

IZ-T Shape

\$ 4.777,00

IZ-T Shape

\$ 3.222,00

» Includes:

- IZ7003
- IZ7004
- IZ7006
- IZ7007
- IZ7005 DAP

» Any other pictured product, other than those listed above, is not included.

» Includes:

- IZ7003
- IZ7004
- IZ7006
- IZ7007
- IZ7005 Stretch

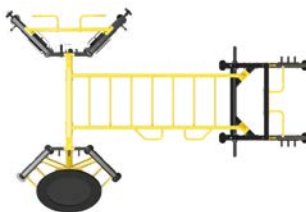

SPECIFICATIONS

Dimensions: 470x314x245 cm
 NET weight: 754,2 kg
 Category: F2

IZ-S Shape

\$ 3.177,40

» Includes:

- IZ7001
- IZ7003
- IZ7011

» Any other pictured product, other than those listed above, is not included.

IZ-S Shape



SPECIFICATIONS

Dimensions: 325x112x237 cm
 NET weight: 283,6 kg
 Category: F2

IZ-I Shape

\$ 2.161,00

» Includes:

- IZ7001
- IZ7002
- IZ7008

» Any other pictured product, other than those listed above, is not included.

IZ-I Shape

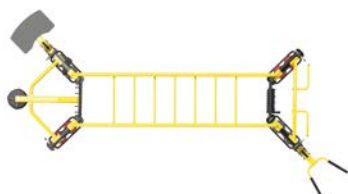

SPECIFICATIONS

Dimensions: 480x166x245 cm
 NET weight: 306 kg
 Category: F2

IZ7001

\$ 870,00

Stretching



SPECIFICATIONS

Dimensions: 165,5x168,3x236,4 cm
 NET weight: 127 kg
 Category: F2

IZ7002

\$ 902,00

Box

» The boxing bag is not included



SPECIFICATIONS

Dimensions: 165,5x112,6x239,0 cm
 NET weight: 142 kg
 Category: F2

IZ7003

\$ 998,00

Rebound



SPECIFICATIONS

Dimensions: 165,5x107,2x234 cm
 NET weight: 154 kg
 Category: F2

IZ7004

\$ 923,00

Half Rack



SPECIFICATIONS

Dimensions: 174,7x140,9x244,3 cm
 NET weight: 167 kg
 Category: F2



IZ7005

\$ 2.425,00



SPECIFICATIONS

Dimensions: 182,6x75,6x236,5 cm

NET weight: 383 kg

Category: F2

Dap

IZ7006

\$ 86,00



SPECIFICATIONS

Dimensions: 152,8x17,8x20,5 cm

NET weight: 13,9 kg

Category: F2

Connector

For IZ-T & IZ-X

IZ7011

\$ 18,40



SPECIFICATIONS

Dimensions: 17,8x10,0x5,0 cm

NET weight: 2,6 kg

Category: F2

"S" Joint

For S-Shape & L-Shape

IZ7007

\$ 345,00

Stair 2
For 4 stations

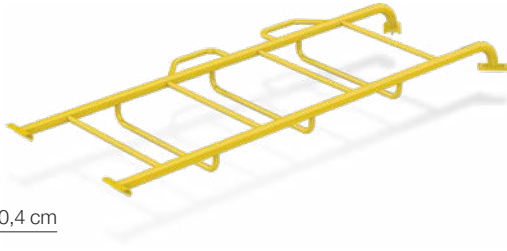

SPECIFICATIONS

Dimensions: 285,0x111,7x20,4 cm
NET weight: 38,3 kg
Category: F2

IZ7008

\$ 389,00

Stair 1
For 2 stations

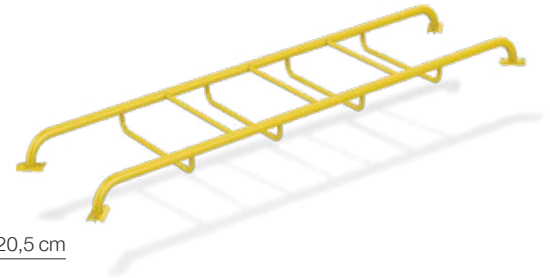

SPECIFICATIONS

Dimensions: 351,0x101,0x20,5 cm
NET weight: 43 kg
Category: F2

IZ7014

\$ 374,00

Stair
For IZ-0



SPECIFICATIONS

Dimensions: 243,5x120,7x20,5 cm
NET weight: 35,6 kg
Category: F2

IZ7015

\$ 258,00

Stair
For IZ-H



SPECIFICATIONS

Dimensions: 240,6x170,4x20,5 cm
NET weight: 53,9 kg
Category: F2

IZ7009

\$ 277,30

Step Attachment

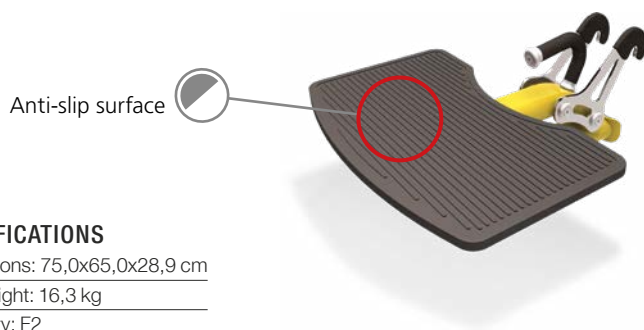

SPECIFICATIONS

Dimensions: 75,0x65,0x28,9 cm
NET weight: 16,3 kg
Category: F2

IZ7010

\$ 186,90

Dip Attachment



SPECIFICATIONS

Dimensions: 94,0x62,4x28,9 cm
NET weight: 12,6 kg
Category: F2

IZ7012

\$ 43,60

Pivot



SPECIFICATIONS

Dimensions: 53,1x12,6x17,8 cm
NET weight: 5,9 kg
Category: F2

IZ7017

\$ 136,00

Battle Rope Storage Reel



SPECIFICATIONS

Dimensions: 65,0x65,0 cm
NET weight: 24,6 kg
Category: F2



Mega Space Line

The Mega Space product line consists of specialized, more functional and customized range of racks designed for gyms.

These products can meet the needs of gyms, clubs and training centers for top quality and functional high quality equipment.



Learn more about the MS line
and the possible combinations at
www.amila.gr scan the QR-code

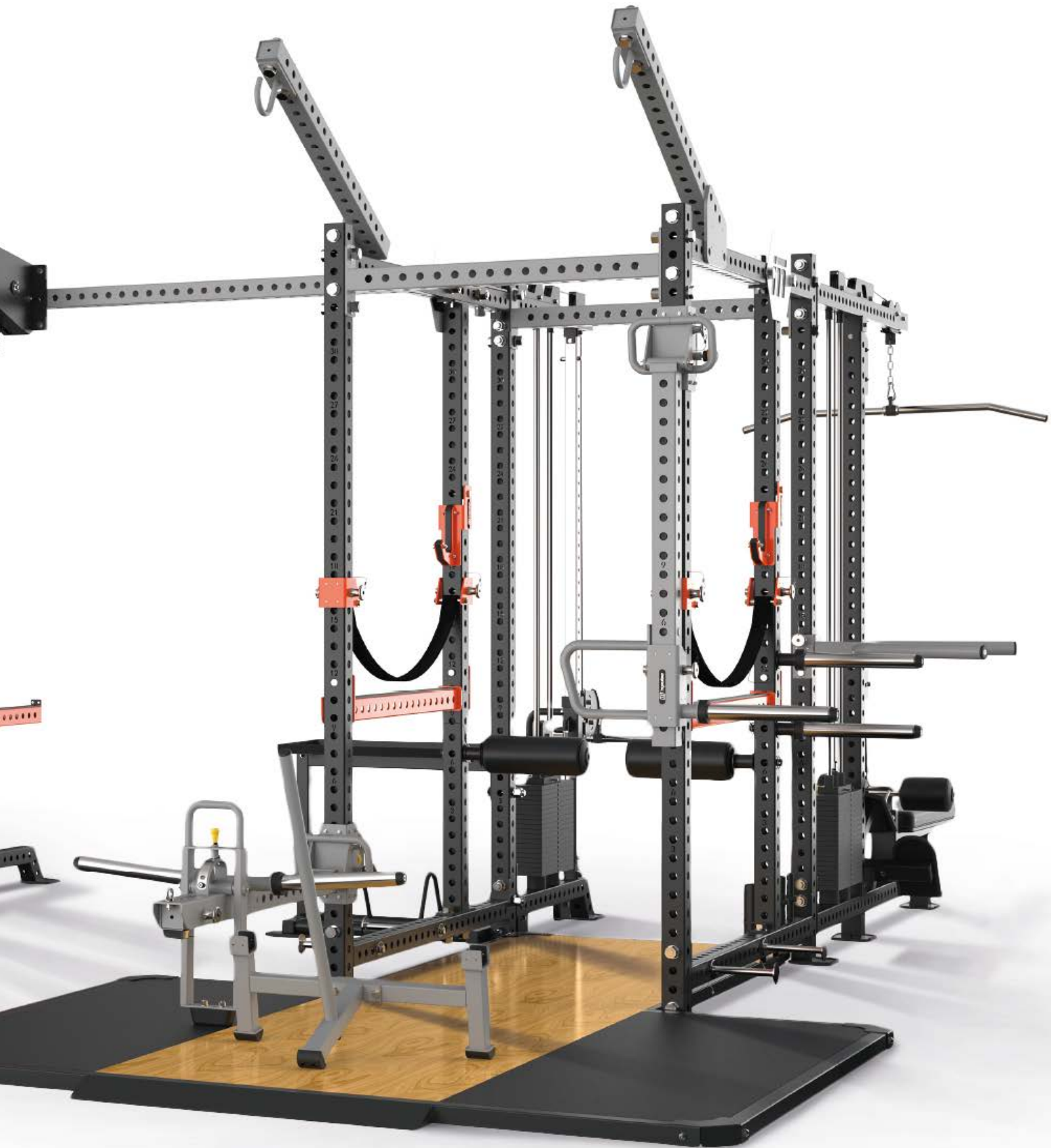

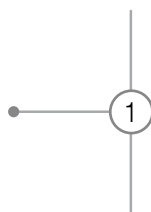

MS00 Stand-Single Storage x 2
 MS11 Lat Pulldown / Vertical Row x 2
 MS12 Functional Cable Pulley x 2
 MS22 Rack Connected Bridge
 Dimensions: 497x272,4x261,4 cm

MS00 Stand-Single Storage x 2
 MS02 Power Rack x 2
 MS11 Lat Pulldown / Vertical Row x 2
 MS12 Functional Cable Pulley x 2
 MS22 Rack Connected Bridge
 Dimensions: 497x453,7x261,4 cm

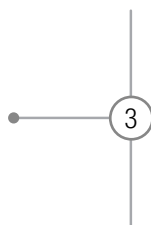
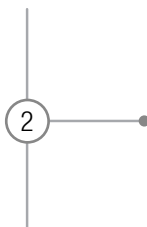

MS00 Stand-Single Storage x 2
 MS02 Power Rack x 4
 MS23 Bumper Plate Storage Connector Between Rack
 MS24 Kettlebell Storage Connector Between Rack
 MS25 Ball Storage Connector Between Rack
 MS26 Dumbbell Storage Connector Between Rack
 Dimensions: 497x468,4x261,4 cm

MS11
 \$ 788,90

LAT Pulldown / Vertical Row

- » Space saving, on the basis of providing the same use function and custom effect of conventional two single-station strength instruments, greatly saving the space.
- » The weight stack is NOT included, you may choose from the ones for IT95 line (p. 352)

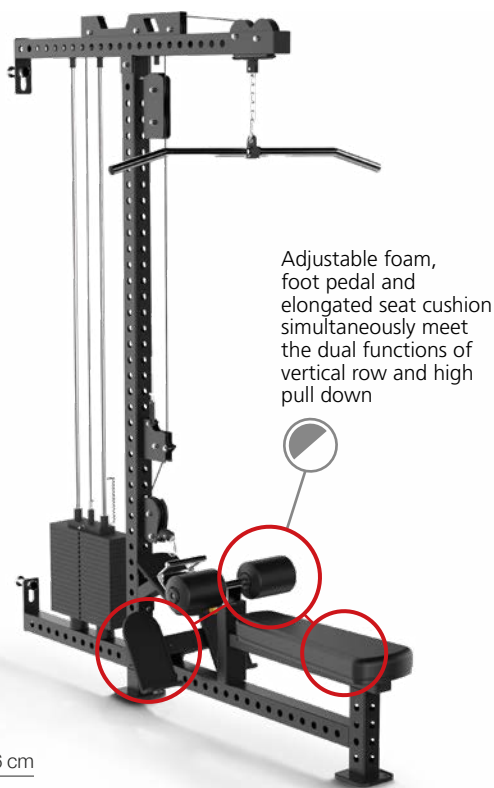

SPECIFICATIONS

Dimensions: 122,6x216,0x259,6 cm
 NET weight: 102 kg
 Category: F2

MS12
 \$ 503,50

Functional Cable Pulley

- » Through collocation can be combined into cable crossover
- » The weight stack is NOT included, you may choose from the ones for IT95 line (p. 352)

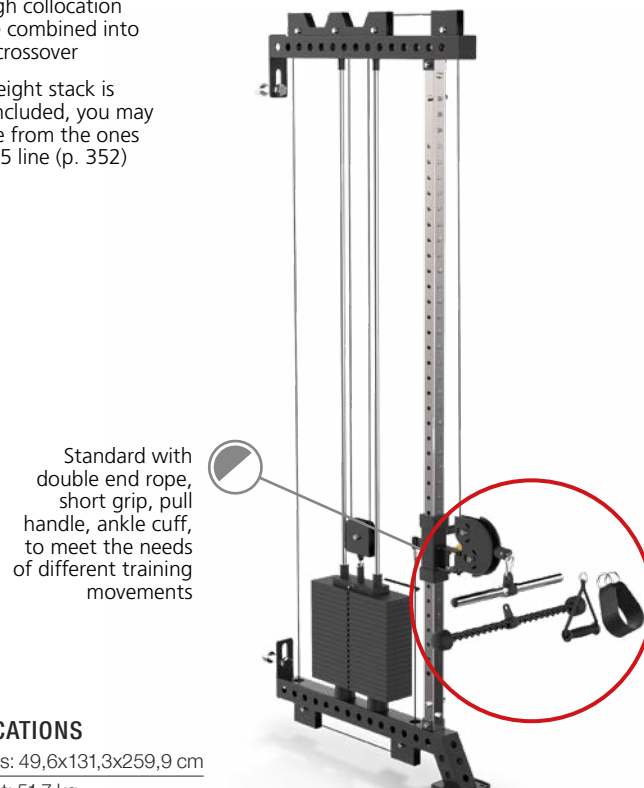

SPECIFICATIONS

Dimensions: 49,6x131,3x259,9 cm
 NET weight: 51,7 kg
 Category: F2

MS00
\$ 374,00

ESENTIAL PART

Stand - Single Storage

- » Use with MS01 and MS02 racks
- » Also connects to MS11 LAT Pulldown/ Vertical Row and MS12 Functional Cable Pulley
- » Can be connected with: MS15, MS23, MS24, MS25, MS26

There are 8 groups of weight plate storage units on the left and right sides, which fully meet the weight plate storage requirements

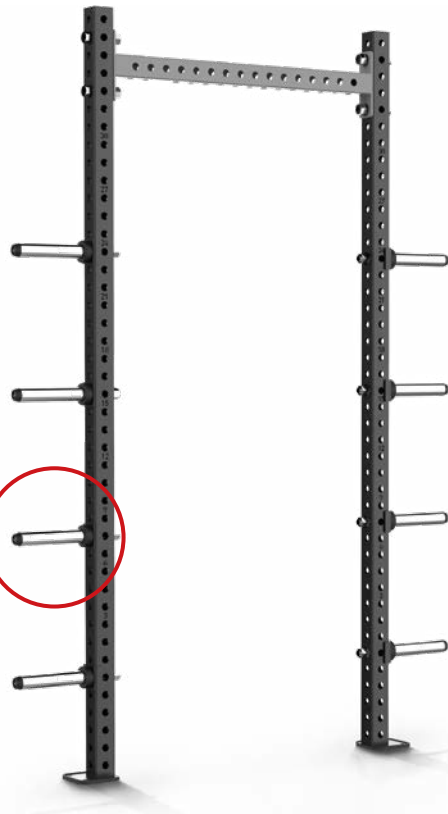

MS01

MS02



MS11

MS12

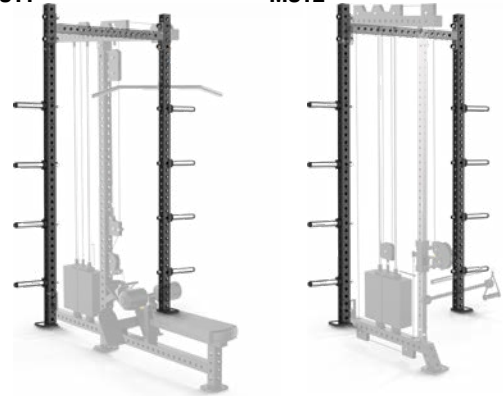

SPECIFICATIONS

Dimensions: 179,0x60,9x261,4 cm
NET weight: 83,4 kg
Category: F2

MS01
\$ 736,00

Half Rack

MS02
\$ 1.120,00

Power Rack

2 J-hooks

30 height positions
{465mm~2145mm
from the ground}

2 spotter arms

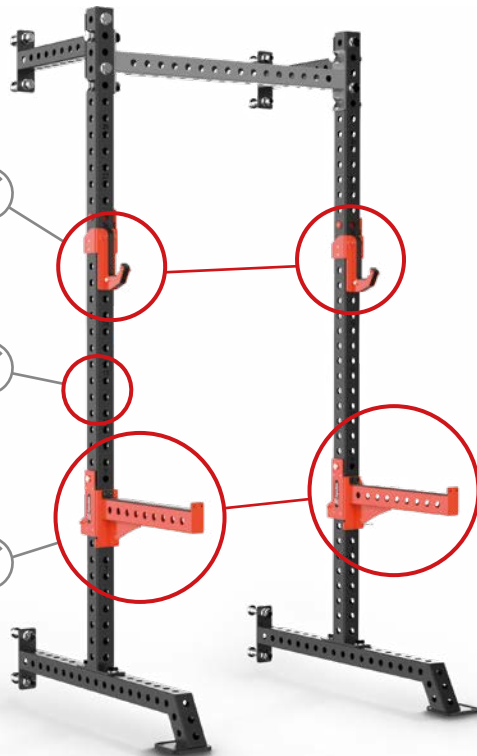

SPECIFICATIONS

Dimensions: 137,7x126,1x261,4 cm
NET weight: 98,3 kg
Category: F2

2 J-hooks

30 height positions
{465mm~2145mm
from the ground}

2 spotter arms



SPECIFICATIONS

Dimensions: 137,7x230,6x261,4 cm
NET weight: 173 kg
Category: F2

MS13

\$ 426,00

Jammer Arms

- » Multi-angle handle to meet the needs of different training movements, while the handle is removable and portable.
- » No disassembly need, can be adjusted up and down to any height, fixed through the bolt
- » Various functions, covering chest, shoulder, back, legs, buttocks and most of the muscle group training movements, and can greatly save space.
- » Can be combined with: MS14, MS45 & MS43

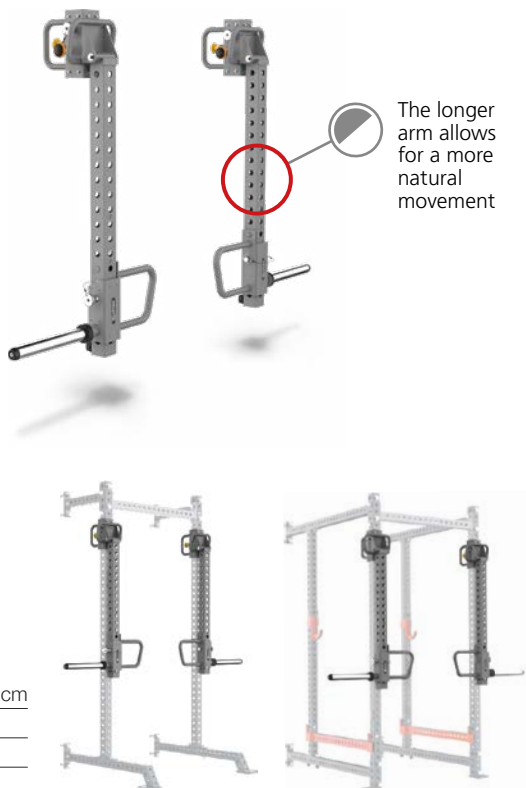

SPECIFICATIONS

Dimensions: 87,5x36,9x139,5 cm
 NET weight: 51 kg
 Pieces / Code: 2
 Category: F2

MS15

\$ 480,00

Endless Rope Trainer

- » Magnetic control resistance adjustment structure is simple, reliable and durable.
- » The resistance of four levels can be adjusted to meet the training needs of different groups

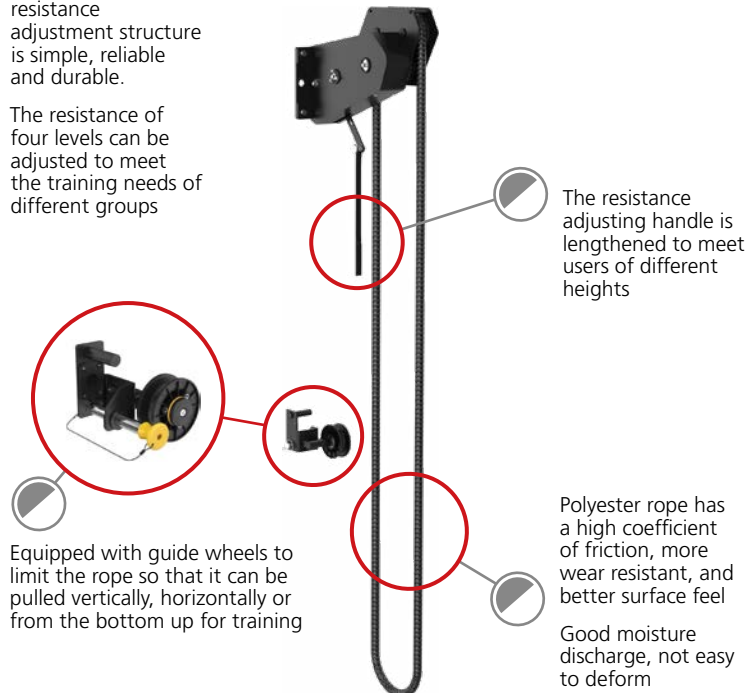

SPECIFICATIONS

Dimensions: 26,6x52,7x53,7 cm
 NET weight: 32,9 kg
 Category: F2

MS31

- » For use with MS00 and MS01, fixed to the metal frames to ensure being firm and reliable
- » Ensures stable support, prevents slip, absorbs shocks, reduces noises and protects the ground

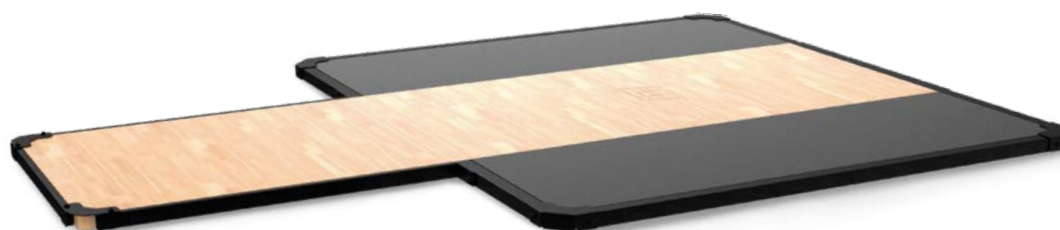

Platform

SPECIFICATIONS

Dimensions: 244,6x342,1x5,0 cm
 NET weight: 264 kg
 Category: F2

CONSTRUCTIONS

Non-slip varnished surface
 Bamboo on top layer
 Composite wood on bottom layer

MS32

- » For use with MS00 and MS02, fixed to the metal frames to ensure being firm and reliable
- » Ensures stable support, prevents slip, absorbs shocks, reduces noises and protects the ground

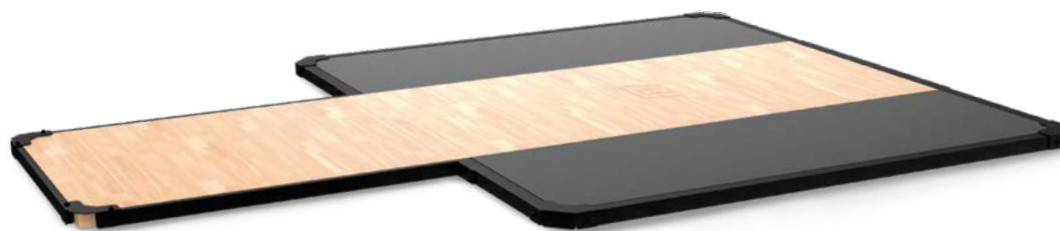

Platform

SPECIFICATIONS

Dimensions: 257,6x382,5x5,4 cm
 NET weight: 280 kg
 Category: F2

CONSTRUCTIONS

Non-slip varnished surface
 Bamboo on top layer
 Composite wood on bottom layer

MS29
\$ 89,00

- » Can be used to connect (back-to-back or 4 together) MS11 and MS12 stations to make groups of machines
- » There is need to connect the stations to a rack

Central Connected Stand

SPECIFICATIONS

Dimensions: 261,4x16,0x16,0 cm
 NET weight: 17,1 kg
 Category: F2

MS28
\$ 140,00

- » Can be used as a horizontal connector to connect groups of stations (MS11 and/or MS12), which groups were made using the vertical MS29 connector

Multi Station Connected Bridge

- » There is need to connect the stations to a rack

SPECIFICATIONS

Dimensions: 14,5x300,0x7,6 cm
 NET weight: 28,5 kg
 Category: F2

MS21
\$ 94,00

- » It can be used as a high bridge to connect the top of the power rack, and can be used as a low connector to connect the bottom of the power rack to match the battle rope and other accessories.

Rack Connected Bridge

SPECIFICATIONS

Dimensions: 205,6x24,0x19,2 cm
 NET weight: 17,3 kg
 Category: F2

MS22
\$ 120,50

- » It can be used as a high bridge to connect the top of the power rack, and can be used as a low connector to connect the bottom of the power rack to match the battle rope and other accessories.

Rack Connected Bridge

SPECIFICATIONS

Dimensions: 275,6x24,0x19,2 cm
 NET weight: 21,4 kg
 Category: F2

HSPCF29
\$ 180,00

- » Can be combined with elastic belt for centripetal, centrifugal, isometric training

Triphasic Training Arms

SPECIFICATIONS

Dimensions: 72,1x108,1x10,5 cm
 NET weight: 32 kg
 Pieces / Code: 2
 Category: F2

IZCFA 16
\$ 86,80

- » All kinds of sandbags can be hung up to 200kg

Heavy Bag Hanger

SPECIFICATIONS

Dimensions: 96,3x76,2x6,0 cm
 NET weight: 12,8 kg
 Category: F2

MS26

\$ 157,80

**Dumbbell Storage Connector
Between Rack**



SPECIFICATIONS

Dimensions: 212,0x38,5x227,0 cm
NET weight: 24 kg
Category: F2

MS24

\$ 220,50

**Kettlebell Storage Connector
Between Rack**



SPECIFICATIONS

Dimensions: 212,0x44,1x10,7 cm
NET weight: 37,5 kg
Category: F2

MS25

\$ 98,60

**Ball Storage Connector
Between Rack**

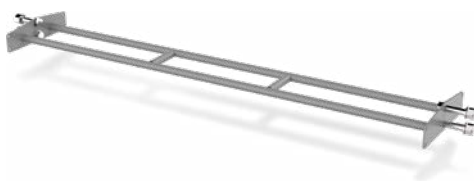

SPECIFICATIONS

Dimensions: 212,0x38,5x10,8 cm
NET weight: 15 kg
Category: F2

MS23

\$ 162,00

**Bumper Plate Storage Connector
Between Rack**



SPECIFICATIONS

Dimensions: 212,0x38,5x28,6 cm
NET weight: 20,1 kg
Category: F2

MS41

\$ 130,00

Adjustable Utility Platform

- » It can be used with the safety bar, and has the function of box jumping
- » Anti-slip paint can effectively prevent skid



SPECIFICATIONS

Dimensions: 134,0x40,0x7,7 cm
NET weight: 20 kg
Category: F2

MS44

\$ 36,00

**Barbell-Utility Platform Storage
Attachment**

- » 2 barbell bar storage positions
- » Utility Platform (MS41) storage Position



SPECIFICATIONS

Dimensions: 28,0x24,0x18,0 cm
NET weight: 6 kg
Category: F2

IZCFA 12

\$ 103,00

* The Wall Balls are not included in the above price of IZCFA12



Combine the target* with the Wall Balls you prefer, according to the material and the weight or make a combination of them, depending on your needs (p. 154-156)

Wall Ball Target

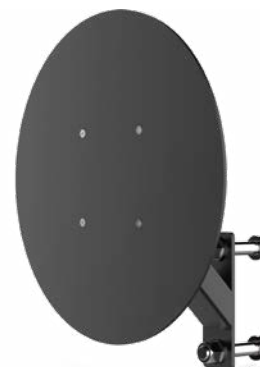

SPECIFICATIONS

Dimensions: 55,0x24,6x60,8 cm
NET weight: 17,6 kg
Category: F2

HSPCF52

\$ 47,20

Landmine Rack Attachment

It is equipped with transverse and longitudinal bearings, so that it can rotate 180° in both axes

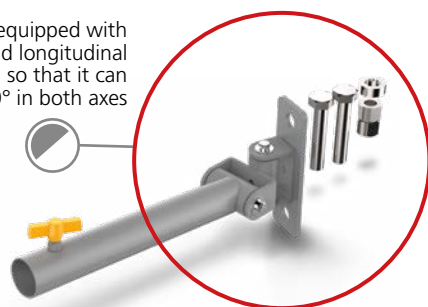

SPECIFICATIONS

Dimensions: 12,6x53,0x24,0 cm
NET weight: 8 kg
Category: F2

MS14

\$ 188,20

Belt Squat

» The hanging angle of the barbell is upturned and lengthened to prevent slippage of the disks.
» Latch fixed to MS13, easy to disassemble.

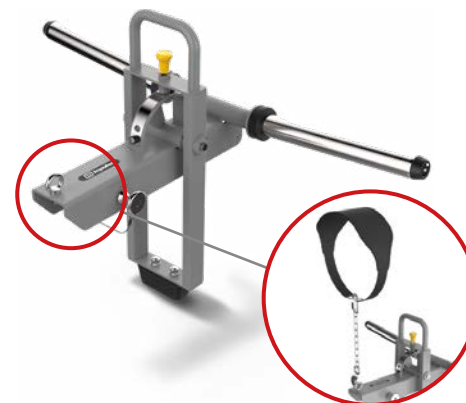

SPECIFICATIONS

Dimensions: 111,2x55,0x67,7 cm
NET weight: 21,8 kg
Category: F2

MS27

\$ 199,00

Side Storage

» Can meet all kinds of ball props such as rhythm ball, wall ball, medicine ball and other storage needs



SPECIFICATIONS

Dimensions: 99,5x41,6x76,3 cm
NET weight: 30,8 kg
Category: F2

HSPCF49

\$ 180,00

Safety Straps

» Bar protector in case of fall



SPECIFICATIONS

Dimensions: 115,0x5,0x1,0 cm
NET weight: 10,1 kg
Pieces / Code: 2
Category: F2

HSPCF28

\$ 80,00

» A variety of width of grips, and multi-angle to meet the needs of different height users



SPECIFICATIONS

Dimensions: 114,3x32,4x10,9 cm
NET weight: 12,8 kg
Category: F2

Multi Angle Pull Up Handle

HSPCF42

\$ 90,90

» When not in use, the latch can be pulled out and vertically fixed and stored on the main frame.



SPECIFICATIONS

Dimensions: 64,9x77,9x25,0 cm
NET weight: 10,1 kg
Category: F2

Tricep Dip Attachment

MS7042

\$ 78,50



SPECIFICATIONS

Dimensions: 144,0x16,9x7,6 cm
NET weight: 15,2 kg
Category: F2

Farmer's Walk Bar

MS7043

\$ 31,60



SPECIFICATIONS

Dimensions: 90,8x25,7x20,5 cm
NET weight: 4,4 kg
Category: F2

T-Bar Row Handle

MS7041

\$ 74,00



SPECIFICATIONS

Dimensions: 78,1x61,8x90,5 cm
NET weight: 11,2 kg
Category: F2

Barbell Lifter

MS7048

\$ 209,20



SPECIFICATIONS

Dimensions: 104,0x70,2x92,2 cm
NET weight: 27,9 kg
Category: F2

Power Sled

MS45

BCMS11500MS

- » It can be placed inside the MS13 Jammer Arm for hip bridge



SPECIFICATIONS

Dimensions: 55,9 cm
 NET weight: 7,3 kg
 Pieces / Code: 2
 Category: F2

Foam Roller Pads

MS43

\$ 73,00

- » At the same time, they can be used for elastic band training



SPECIFICATIONS

Dimensions: 59,0 cm
 NET weight: 6,8 kg
 Pieces / Code: 2
 Category: F2

Adjustable Utility Pins

HSPCF54

\$ 105,90

- » Used to place the bar before/after exercising



SPECIFICATIONS

Dimensions: 22,4x29,6x22,4 cm
 NET weight: 6,8 kg
 Pieces / Code: 2
 Category: F2

J Hook Attachment

HSPCF51

\$ 22,30

- » Used as a fixed point for the battle rope when training



SPECIFICATIONS

Dimensions: 7,0x15,2x18,0 cm
 NET weight: 2,1 kg
 Category: F2

Battle Rope Anchor

HSPCF59

\$ 78,20

- » Gripping strength training attachment
- » Three different grips



SPECIFICATIONS

Dimensions: 20,7/32,1/44,3x20,9x7,6 cm
 NET weight: 7,8 kg
 Pieces / Code: 7
 Category: F2

Ball Grip Attachment

HSPCF47

\$ 60,90

- » Serve as elastic belt hangpoints to meet advanced strength training

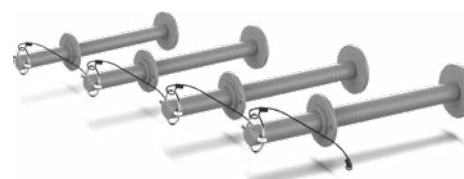

SPECIFICATIONS

Dimensions: 30,5 cm
 NET weight: 6,2 kg
 Pieces / Code: 4
 Category: F2

Resistant Band Anchor



[SE] Sterling Elite Series

The Sterling Elite series offers maximum flexibility and highly commercial exercise solutions with its customizable modular design.

The wide variety of combinations that can be achieved with the series' machines meet the special needs of training centers, gyms, as well as studios looking for strength training or CrossFit equipment.

They are made from thicker tubing and more durable materials than the SL series, ensuring you stay safe and get the most out of your workout.



Learn more about the SE line and the possible combinations at www.amila.gr scan the QR-code



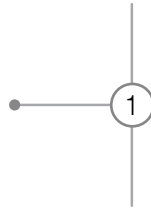

SE5001 Half Rack
SE5011 Stand-Single Storage
SE5031 Platform

SE5002 Power Rack
SE5011 Stand-Single Storage
SE5031 Platform

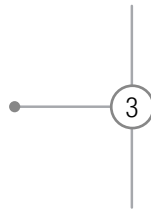
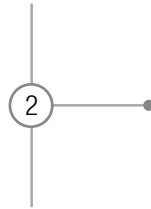

SE5001 Half Rack
SE5002 Power Rack
SE5012 Combo Storage-Single

SE5002 Power Rack x 2
SE5012 Combo Storage-Single

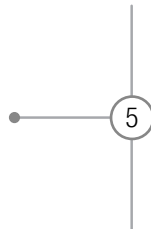
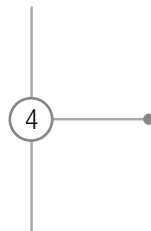

SE5001 Half Rack
SE5002 Power Rack
SE5011 Stand-Single Storage x 2
SE5025 Ball Storage Connector
SE5024 Free Storage Connector
SE5021 Rack Connector / Multi-Grip

SE5001 Half Rack x 3
SE5002 Power Rack
SE5012 Combo Storage-Single x 2
SE5025 Ball Storage Connector
SE5024 Free Storage Connector
SE5023 Bumper Plate Storage Connector
SE5021 Rack Connector / Multi-Grip
SE5031 Platform

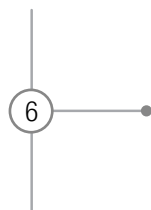

SE5001

\$ 692,00

Half Rack



SPECIFICATIONS

Dimensions: 133,8x130,1x247,6 cm
 NET weight: 118,3 kg
 Category: F2

SE5002

\$ 945,50

Power Rack



SPECIFICATIONS

Dimensions: 133,8x196,8x247,6 cm
 NET weight: 193,3 kg
 Category: F2

SE5011

\$ 269,00

Stand-Single Storage

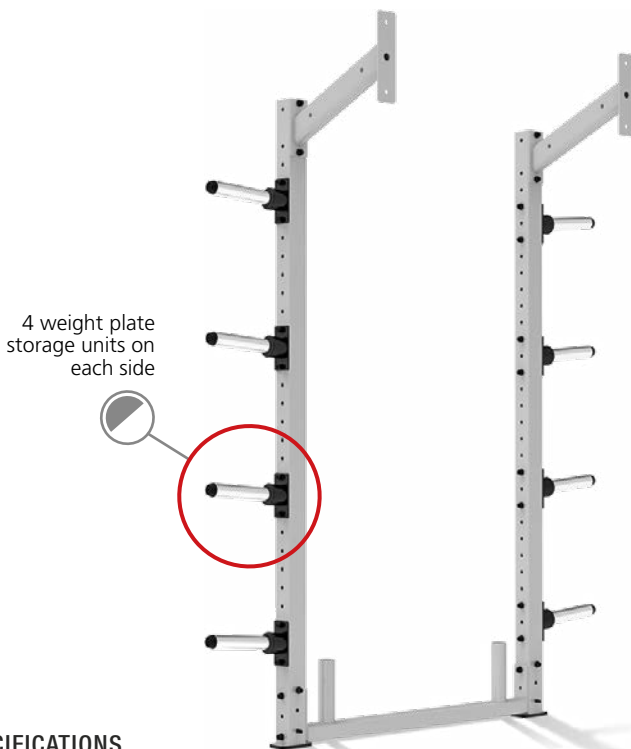

SPECIFICATIONS

Dimensions: 184,2x56,3x246,6 cm
 NET weight: 64,4 kg
 Category: F2

SE5012

\$ 305,00

Combo Storage-Single

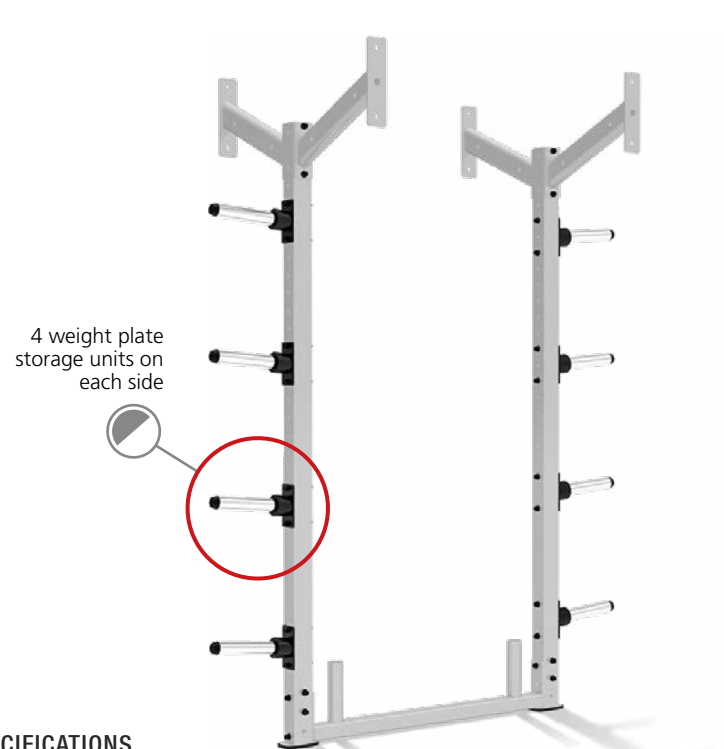

SPECIFICATIONS

Dimensions: 184,2x103,1x246,6 cm
 NET weight: 73,4 kg
 Category: F2

SE5021

\$ 128,00

Rack Connector / Multi-Grip**SPECIFICATIONS**

Dimensions: 190,0x22,5x23,0 cm

NET weight: 19,5 kg

Category: F2

SE5022

\$ 43,00

Rack Connector-Thick Straight**SPECIFICATIONS**

Dimensions: 190,0x7,6x23,0 cm

NET weight: 8 kg

Category: F2

SE5023

\$ 116,00

Bumper Plate Storage Connector**SPECIFICATIONS**

Dimensions: 190,0x7,6x23,0 cm

NET weight: 24,5 kg

Category: F2

SE5024

\$ 192,00

Free Storage Connector**SPECIFICATIONS**

Dimensions: 190,0x43,2x17,1 cm

NET weight: 36,5 kg

Category: F2

SE5025

\$ 65,00

Ball Storage Connector**SPECIFICATIONS**

Dimensions: 190,0x28,0x26,0 cm

NET weight: 14 kg

Category: F2

SE5043

\$ 163,00

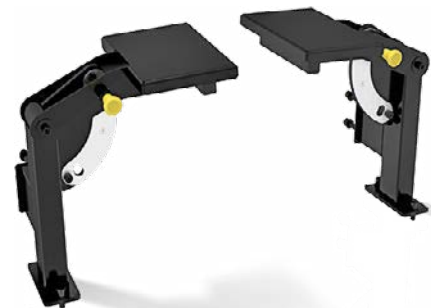
Spotter Stands**SPECIFICATIONS**

Dimensions: 40,0x23,5x44,2 cm

NET weight: 24 kg

Pieces / Code: 2

Category: F2

HZ7010

\$ 109,00

Dip Attachment



SPECIFICATIONS

Dimensions: 62,5x94,6x33,9 cm
NET weight: 12,6 kg
Category: F2

HZ7009

\$ 204,00

Step Attachment



SPECIFICATIONS

Dimensions: 66,1x77,3x33,8 cm
NET weight: 16,3 kg
Category: F2

IZ7012

\$ 43,60

Pivot

» Can be used ONLY with SE5002



SPECIFICATIONS

Dimensions: 12,6x53,0x28,9 cm
NET weight: 5,9 kg
Category: F2

SE5041

\$ 22,00

Band Pegs

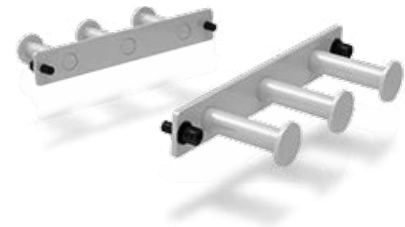

SPECIFICATIONS

Dimensions: 32,5x10,1x5,0 cm
NET weight: 4,5 kg
Pieces / Code: 2
Category: F2

SE5042

\$ 87,00

Reverse J-Hooks



SPECIFICATIONS

Dimensions: 9,5x25,2x25,0 cm
NET weight: 13,7 kg
Pieces / Code: 2
Category: F2

in impulse

H-Zone Line

Specially designed to provide flexibility and functionality, allows you to use the full area of your gym, even curved, narrow and difficult to access areas.

All stations can be securely attached to the wall.



Learn more about the HZ line
and the possible combinations at
www.amila.gr scan the QR-code



Two connectors offering full flexibility and adaptability, even in the most demanding areas

Multi-Function Connector

The HZ7004 multifunctional connector allows the flexible connection of the stations to it, giving you the freedom to combine the stations and their accessories any way you like



Wall Connector

The HZ7006 wall connector, due to its rotatable fixing plates, allows the fixation of the stations to any wall in any angle, offering superb stability

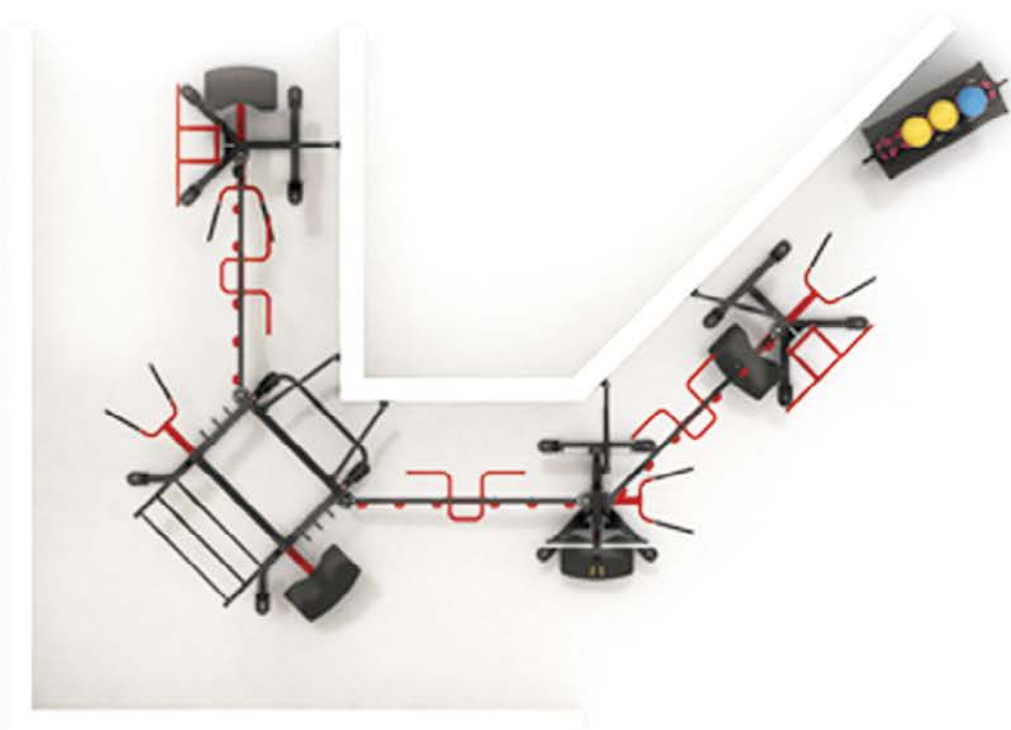

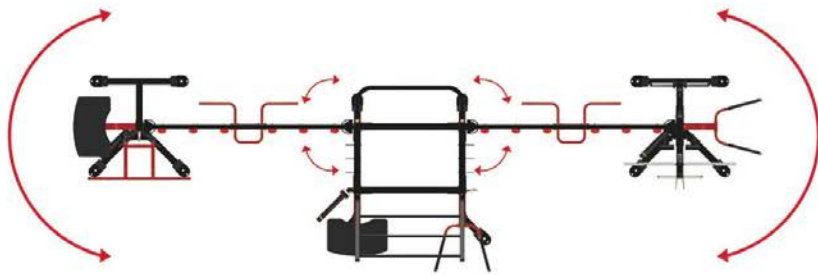

Impulse inovated to maximize the usability of the Rack and Hi-Low pulley stations

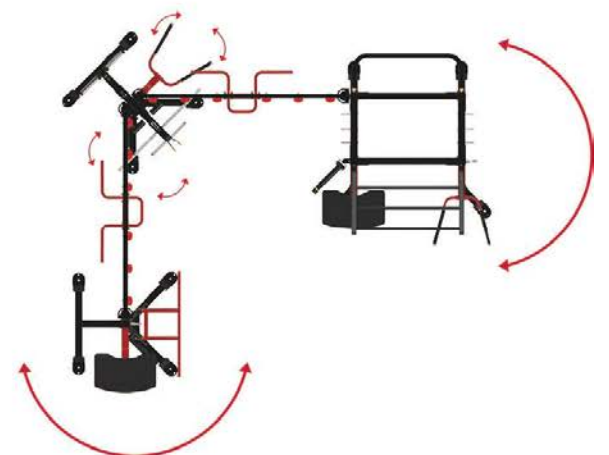

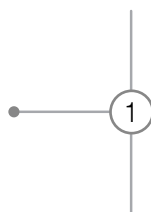

HZ7002 Hi-Low Pulley Station x 2
 HZ7004 Multi-Function Connector

HZ7001 Power Rack Station
 HZ7002 Hi-Low Pulley Station
 HZ7003 Multi-Function Station
 HZ7004 Multi-Function Connector x 2

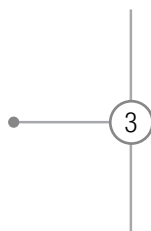
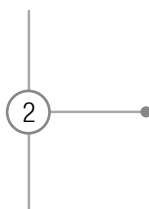

HZ7001 Power Rack Station
 HZ7002 Hi-Low Pulley Station
 HZ7003 Multi-Function Station
 HZ7004 Multi-Function Connector x 2

HZ7010

\$ 109,00

Dip Attachment



SPECIFICATIONS

Dimensions: 62,5x94,6x33,9 cm
 NET weight: 12,6 kg
 Category: F2

HZ7009

\$ 204,00

Step Attachment



SPECIFICATIONS

Dimensions: 66,1x77,3x33,8 cm
 NET weight: 16,3 kg
 Category: F2

IZ7012

\$ 43,60

Pivot



SPECIFICATIONS

Dimensions: 12,6x53,0x28,9 cm
 NET weight: 5,9 kg
 Category: F2

HZ7001

\$ 960,00

Power Rack Station



SPECIFICATIONS

Dimensions: 173,7x172,3x255,8 cm
 NET weight: 180,0 kg
 Category: F2

HZ7002

\$ 540,00

Hi-Low Pulley Station



SPECIFICATIONS

Dimensions: 110,6x110,9x241,3 cm
 NET weight: 82 kg
 Category: F2

HZ7004

\$ 132,00

Multi-Function Connector



SPECIFICATIONS

Dimensions: 228,4x45,3x20,3 cm
 NET weight: 30 kg
 Category: F2

HZ7006

\$ 28,00

Wall Connector



SPECIFICATIONS

Dimensions: 86,6x20,0x7,5 cm
 NET weight: 6 kg
 Category: F2

in *impulse*

SL Line

Ease of Use - Pretty Appearance

SL line boasts a high quality construction for commercial use with user friendly design, which makes working out more simple, efficient, comfortable and satisfying.

Compact design, demanding the least possible space, while the resistance is adjusted by adding/removing disks.



Tubing with thickness ranging from 2.5mm to 3mm, 50mmx100mm, electro-welded for maximum integrity

Electrostatic powder-coated and heat cured after adhesiveness enhancement pre-treatment for superior durability

Pad total thickness is 70mm

Place disks to change the resistance

Easy-to-use, flexible adjustments allow for optimal exercise positions

2 weight plate storage units on each side



Learn more about the SL line at www.amila.gr scan the QR-code

Muscle groups:
● Main ● Secondary

SL7042

\$ 2.460,00



SPECIFICATIONS

Dimensions: 232x224x239 cm
 NET weight: 313 kg
 Weight capacity: 300 kg
 Category: F2

Magic Rack / Smith Machine

Ergonomic pull-up grips

4 weight plate storage units on each side

7 fixed-position J-hooks

Landmine

2 spotter arms



SL7009

\$ 1.195,00

Power Rack



10 fixed-position J-hooks

Ergonomic pull-up grips



SPECIFICATIONS

Dimensions: 203x150x228 cm
 NET weight: 200 kg
 Weight capacity: 400 kg
 Category: F2

SL7009OPT

\$ 364,00

Weight Plate Rack Option

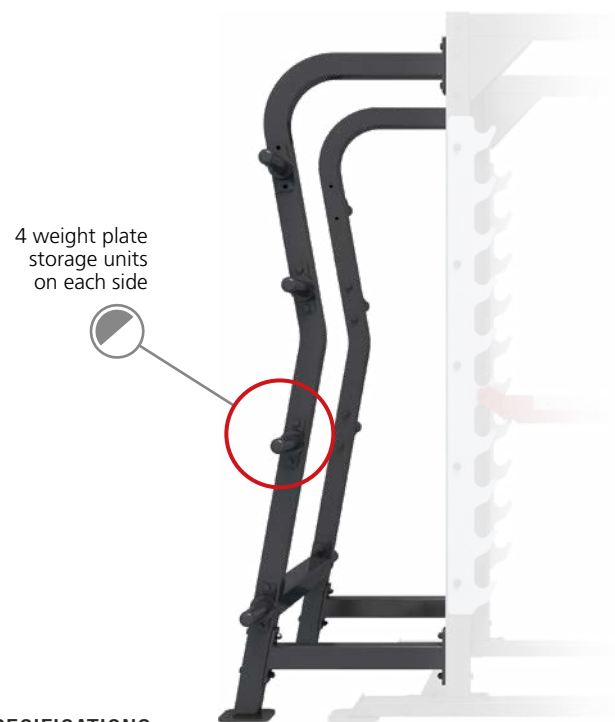

4 weight plate storage units on each side



SPECIFICATIONS

Dimensions: 167x72x220 cm
 NET weight: 63,5 kg
 Category: F2

Half Rack

SL7014

\$ 815,00



SPECIFICATIONS

Dimensions: 139x175x244 cm

NET weight: 153 kg

Weight capacity: 400 kg

Category: F2

Full Rack

SL7015

\$ 1.065,00

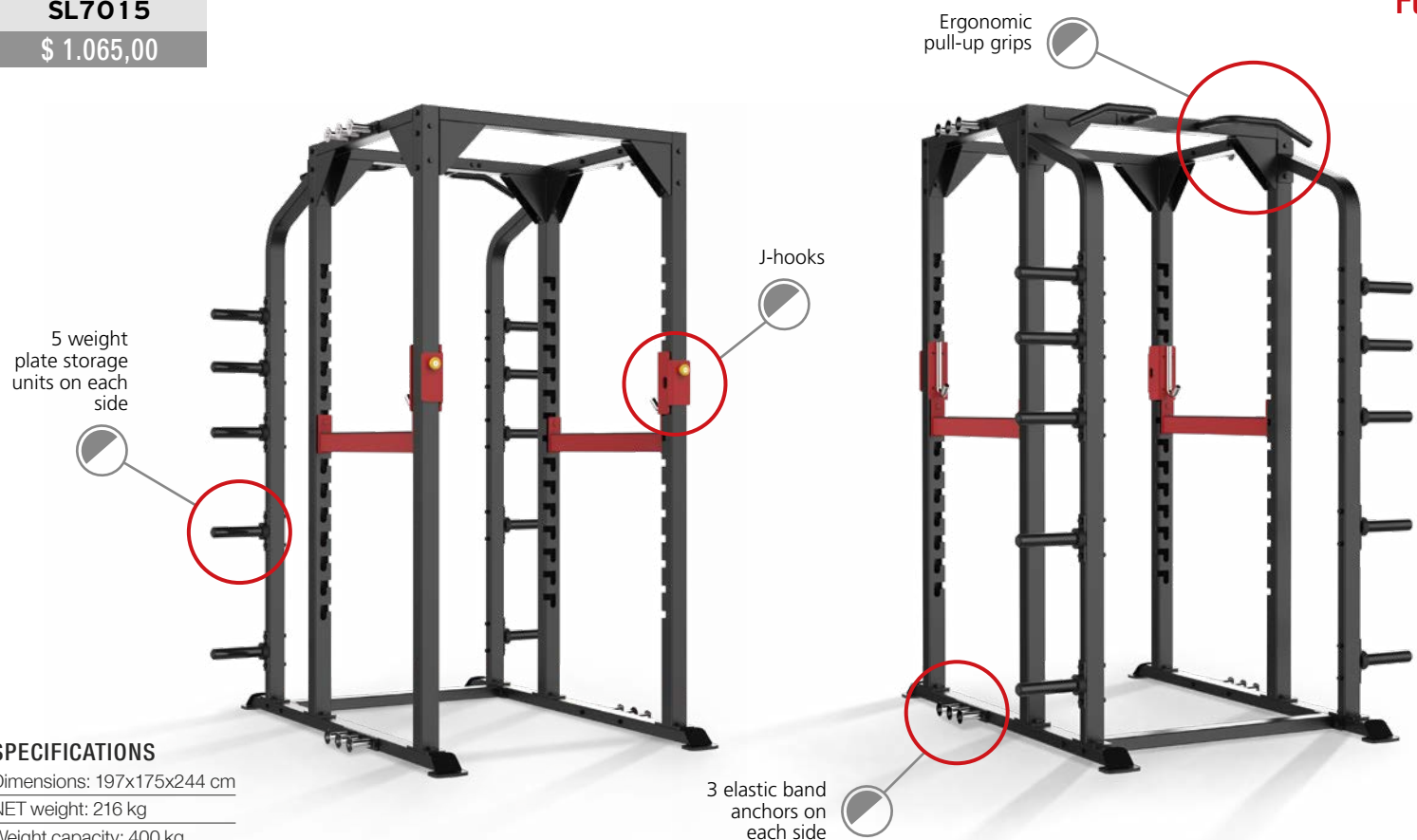

SPECIFICATIONS

Dimensions: 197x175x244 cm

NET weight: 216 kg

Weight capacity: 400 kg

Category: F2

SL7011

\$ 295,00

FID Bench



SPECIFICATIONS

Dimensions: 150x66x136 cm

NET weight: 44 kg

Weight capacity: 150 kg

Category: F2

SL7012

\$ 355,00

FID Bench



SPECIFICATIONS

Dimensions: 155x67x135 cm

NET weight: 47 kg

Weight capacity: 150 kg

Category: F2

SL7043

\$ 415,00

Multi AB Bench

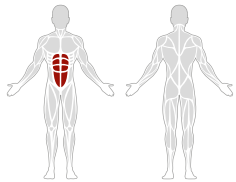

SPECIFICATIONS

Dimensions: 63,0x172,2x91,2 cm

NET weight: 54 kg

Weight capacity: 150 kg

Category: F2

SL7035

\$ 191,00

Flat Bench



SPECIFICATIONS

Dimensions: 135x123x151 cm

NET weight: 25.3 kg

Category: F2

SL7022

\$ 177,00

Utility Bench



SPECIFICATIONS

Dimensions: 119x63x82,2 cm

NET weight: 27,8 kg

Category: F2

SL7010

\$ 295,00

Plate Rack



SPECIFICATIONS

Dimensions: 89x62,8x122,8 cm

NET weight: 44 kg

Category: F2

SL7027

\$ 510,00

Barbell Rack



SPECIFICATIONS

Dimensions: 95,0x91,0x161,2 cm

NET weight: 73,0 kg

Category: F2

SL7016

\$ 474,50

Dumbbell Rack

For Round Dumbbells

* The pictured dumbbells are not included in the price



SPECIFICATIONS

Dimensions: 123x119x151 cm

NET weight: 124 kg

Category: F2

Combine the Dumbbell Rack* by choosing the dumbbells you like according to their material and weight (p. 116-119)

SL7001

\$ 1.130,00

Chest Press

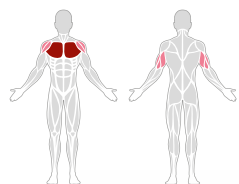

SPECIFICATIONS

Dimensions: 198,0x137,5x171,8 cm
 NET weight: 171 kg
 Weight capacity: 300 kg
 Category: F2

SL7005

\$ 1.195,00

Incline Chest Press

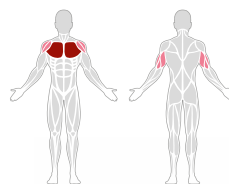

SPECIFICATIONS

Dimensions: 207,2x152,3x176,5 cm
 NET weight: 184 kg
 Weight capacity: 300 kg
 Category: F2

SL7046

\$ 1.340,00

Iso-Lateral Super Chest Press

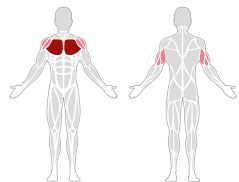

SPECIFICATIONS

Dimensions: 217,1x249,2x113,2 cm
 NET weight: 148kg
 Weight capacity: 150 kg
 Category: F2

SL7039

\$ 1.133,00

Standing Press

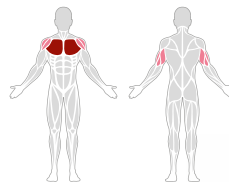

SPECIFICATIONS

Dimensions: 217,1x200,0x213,5 cm
 NET weight: 181.4kg
 Weight capacity: 300 kg
 Category: F2

SL7003

\$ 1.120,00

Shoulder Press

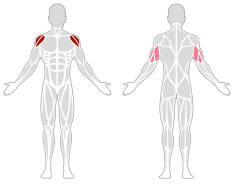

SPECIFICATIONS

Dimensions: 175,4x154,5x148,2 cm
 NET weight: 171 kg
 Weight capacity: 300 kg
 Category: F2

SL7024

\$ 1.155,00

Tricep Dip

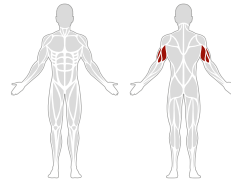

SPECIFICATIONS

Dimensions: 157,8x173,1x120,4 cm
 NET weight: 166 kg
 Weight capacity: 300 kg
 Category: F2

SL7007

\$ 1.094,00

Row

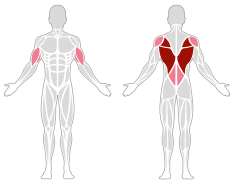

SPECIFICATIONS

Dimensions: 145,5x181,5x133,4 cm
 NET weight: 160 kg
 Weight capacity: 300 kg
 Category: F2

SL7002

\$ 1.132,00

Pulldown

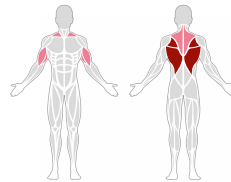

SPECIFICATIONS

Dimensions: 140,8x165,9x197,3 cm
 NET weight: 169 kg
 Weight capacity: 300 kg
 Category: F2

SL7004

\$ 1.168,00

Low Row

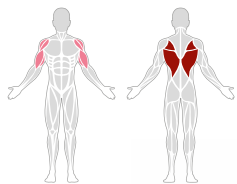

SPECIFICATIONS

Dimensions: 152,6x176,1x165,2 cm
 NET weight: 170 kg
 Weight capacity: 300 kg
 Category: F2

SL7019

\$ 592,00

Incline Row

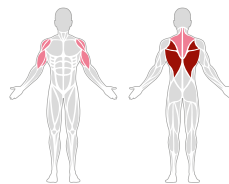

SPECIFICATIONS

Dimensions: 104,8x196,3x126,2 cm
 NET weight: 89 kg
 Weight capacity: 150 kg
 Category: F2

SL7018

\$ 456,50

Arm Curl

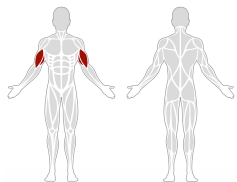

SPECIFICATIONS

Dimensions: 114x86x102 cm
 NET weight: 70 kg
 Weight capacity: 300 kg
 Category: F2

SL7023

\$ 885,00

Bicep Curl

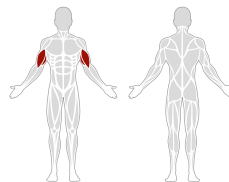

SPECIFICATIONS

Dimensions: 104,5x149,4x119,9 cm
 NET weight: 114 kg
 Weight capacity: 120 kg
 Category: F2

SL7020

\$ 2.182,00

Reverse Leg Press

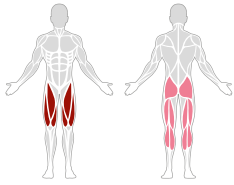

SPECIFICATIONS

Dimensions: 193,3x246,1x153,4 cm
 NET weight: 249 kg
 Weight capacity: 450 kg
 Category: F2

SL7021

\$ 1.718,00

Hack Squat

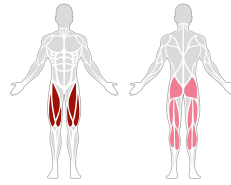

SPECIFICATIONS

Dimensions: 188,0x220,6x128,6 cm
 NET weight: 236 kg
 Weight capacity: 400 kg
 Category: F2

SL7006

\$ 1.238,00

Leg Press

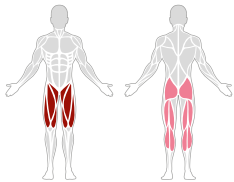

SPECIFICATIONS

Dimensions: 142,1x226,6x141,5 cm
 NET weight: 195 kg
 Weight capacity: 400 kg
 Category: F2

SL7025

\$ 1.030,00

Leg Extension

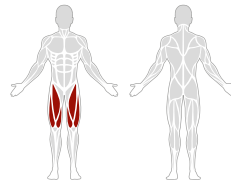

SPECIFICATIONS

Dimensions: 169,0x134,5x103,7 cm
 NET weight: 131 kg
 Weight capacity: 300 kg
 Category: F2

SL7038

\$ 755,00

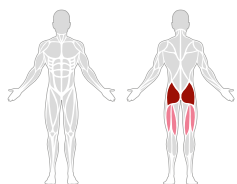

Total Hip



SPECIFICATIONS

Dimensions: 160,8x161,8x110,6 cm
 NET weight: 115 kg
 Weight capacity: 150 kg
 Category: F2

SL7040

\$ 760,00

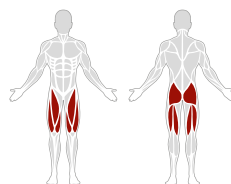

Squat Lunge



SPECIFICATIONS

Dimensions: 169,4x166,8x63,6 cm
 NET weight: 123 kg
 Weight capacity: 300 kg
 Category: F2

SL7026

\$ 1.058,00

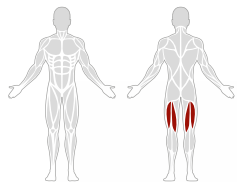

Leg Curl



SPECIFICATIONS

Dimensions: 130,0x152,7x140,6 cm
 NET weight: 141 kg
 Weight capacity: 120 kg
 Category: F2

SL7055

\$ 1.025,00

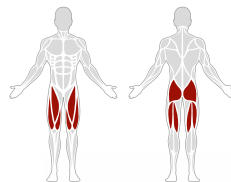

Belt Squat



SPECIFICATIONS

Dimensions: 197,2x151,1x113,7 cm
 NET weight: 146 kg
 Weight capacity: 300 kg
 Category: F2

SL7051

\$ 665,00

Assisted Nordic Ham

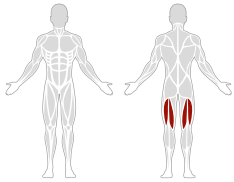

SPECIFICATIONS

Dimensions: 164,8x132,3x168,4 cm
 NET weight: 101 kg
 Weight capacity: 100 kg
 Category: F2

SL7057

\$ 1.050,00

Pendulum Squat

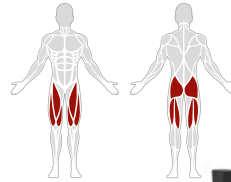

SPECIFICATIONS

Dimensions: 225,2x131,4x167,5 cm
 NET weight: 250 kg
 Weight capacity: 200 kg
 Category: F2

SL7034

\$ 1.385,00

Squat

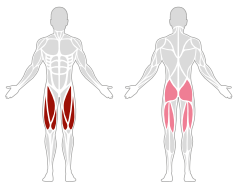

SPECIFICATIONS

Dimensions: 155,5x230,2x126,6 cm
 NET weight: 212 kg
 Weight capacity: 400 kg
 Category: F2

SL7008

\$ 940,00

Rear Kick

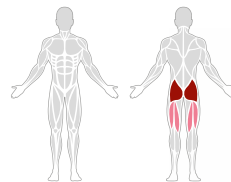

SPECIFICATIONS

Dimensions: 129,9x168,0x163,8 cm
 NET weight: 144 kg
 Weight capacity: 150 kg
 Category: F2

SL7032

\$ 1.005,00

Standing Calf Raise

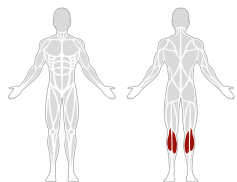

SPECIFICATIONS

Dimensions: 160,5x148,5x181,3 cm
 NET weight: 146 kg
 Weight capacity: 300 kg
 Category: F2

SL7017

\$ 395,00

Seated Calf Raise

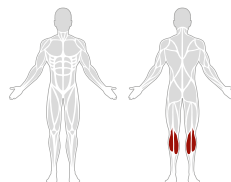

SPECIFICATIONS

Dimensions: 75,7x147,5x84,4 cm
 NET weight: 56 kg
 Weight capacity: 150 kg
 Category: F2

SL7013

\$ 548,00

Glute Ham Bench

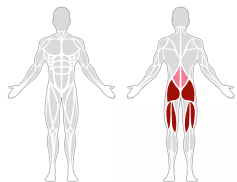

SPECIFICATIONS

Dimensions: 89,9x155,9x148,2 cm
 NET weight: 70 kg
 Weight capacity: 150 kg
 Category: F2

SL7047

\$ 419,50

Multi Hyper Extension

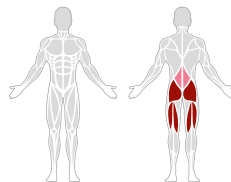

SPECIFICATIONS

Dimensions: 94,7x134,0x87,2 cm
 NET weight: 55 kg
 Weight capacity: 150 kg
 Category: F2

SL7029

\$ 776,00

Incline Bench

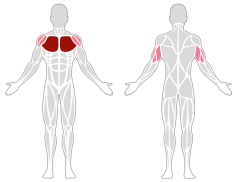

SPECIFICATIONS

Dimensions: 171,8x205,9x149,6 cm
 NET weight: 113 kg
 Weight capacity: 300 kg
 Category: F2

SL7030

\$ 695,00

Decline Bench

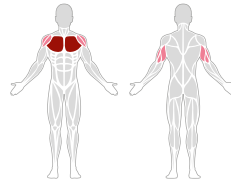

SPECIFICATIONS

Dimensions: 171,8x237,0x131,5 cm
 NET weight: 110 kg
 Weight capacity: 300 kg
 Category: F2

SL7041

\$ 1.141,00

Super Olympic Bench

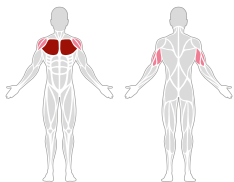

SPECIFICATIONS

Dimensions: 241,0x174,3x162,2 cm
 NET weight: 141 kg
 Weight capacity: 300 kg
 Category: F2

SL7028

\$ 647,00

Flat Bench

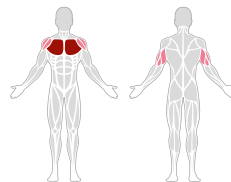

SPECIFICATIONS

Dimensions: 173,8x191,0x131,5 cm
 NET weight: 112 kg
 Weight capacity: 300 kg
 Category: F2

SL7036

\$ 1.058,00

Abdominal

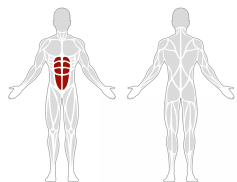

SPECIFICATIONS

Dimensions: 134,4x126,7x164,2 cm
 NET weight: 132 kg
 Weight capacity: 120 kg
 Category: F2

SL7031

\$ 988,00

Shoulder Bench Press

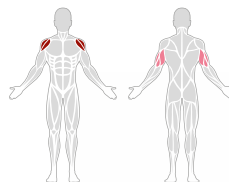

SPECIFICATIONS

Dimensions: 171,9x126,1x192,0 cm
 NET weight: 147 kg
 Weight capacity: 400 kg
 Category: F2

SL7045

\$ 455,00

Vertical Knees Raise / Dip Stand

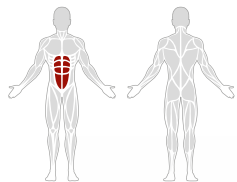

SPECIFICATIONS

Dimensions: 76,5x118,9x153,7 cm
 NET weight: 74 kg
 Weight capacity: 150 kg
 Category: F2

SL7045OPT

\$ 175,00

Chin-up and Dip
 (add-on of SL7045)

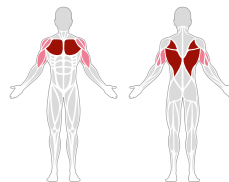

SPECIFICATIONS

Dimensions: 113,0x118,9x238,7 cm
 NET weight: 32 kg
 Weight capacity: 150 kg
 Category: F2

in *impulse*

ECP Line

Ease of use, effective training and safety

The EVOLUTION CURVE series by Impulse represents a groundbreaking line of plate-loaded strength machines, developed from 30 years of expertise in strength training coupled with the latest demands in the field.

Incorporating a linkage-adjustable force structure in most models, these machines are tailored to match the strength curve characteristics of specific muscle groups, ensuring user comfort, training efficiency, and safety throughout the workout.



- » The maintenance-free feature of plate-loaded machines: The entire ECP series is designed with maintenance-free features. The training handles are made of aluminum and the hanging rods are constructed of stainless steel. This design minimizes the use of easily damaged materials such as plastics, reducing economic expenditures for end customers on maintenance.
- » Each product is equipped with elastic band attachment points and storage slots, enabling progressive resistance training for a variety of workout options.

- » To provide strength trainers with an exceptional visual sense of power, the main components of the entire series consist of trapezoidal, triangular, and rectangular tubes. The use of angular-shaped tubes enhances the visual experience of strength training.
- » Utilizing PU seat cushions meets both environmental and comfort requirements. The entire series features foot pedals coated with anti-slip paint and embedded anti-slip rubber, enhancing training experience and safety while achieving maintenance-free operation.

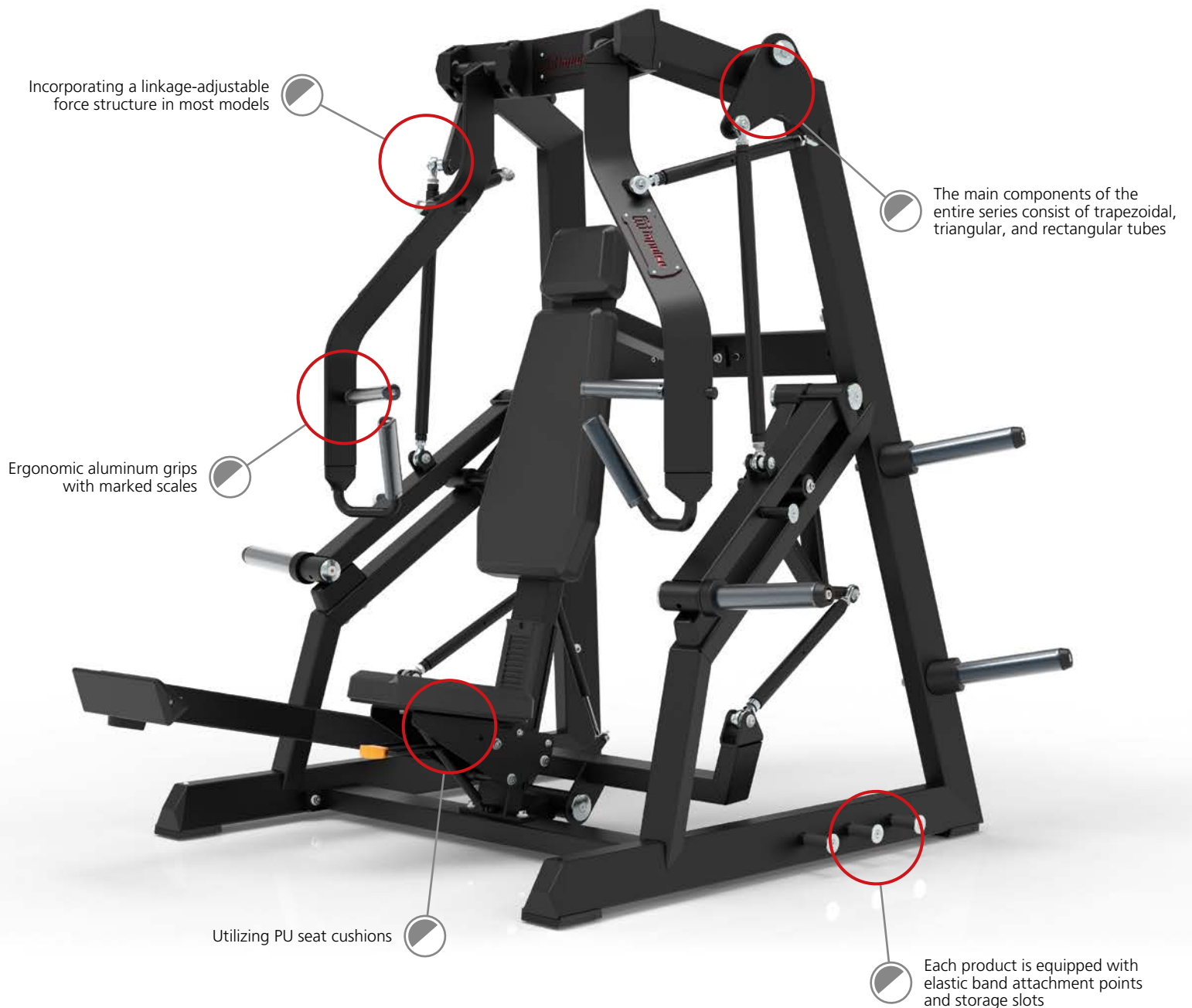

Learn more about the ECP line at www.amila.gr scan the QR-code

Muscle groups:
● Main ● Secondary

ECP201

\$ 1.625,00

Chest Press

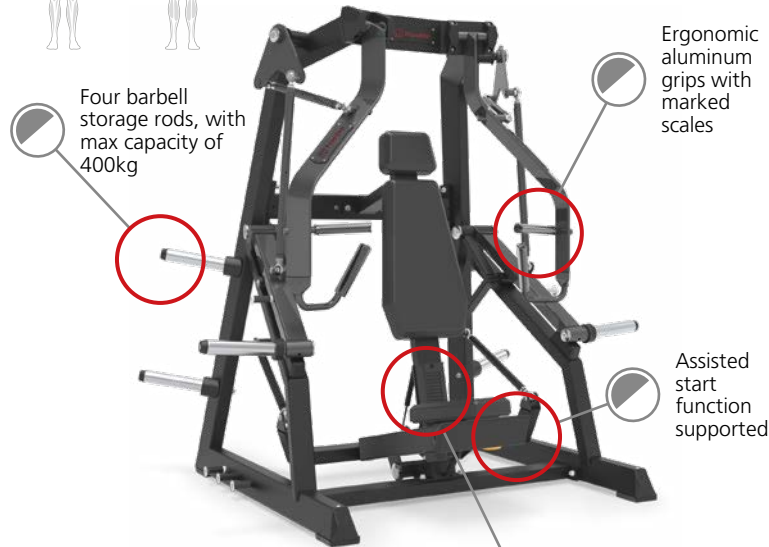
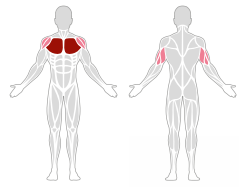

SPECIFICATIONS

Dimensions: 180,0x175,0x180,0 cm
 NET weight: 265 kg
 Weight capacity: 200 kg
 Category: F2

18 level adjustable seat height

ECP101

\$ 1.327,00

Shoulder Press

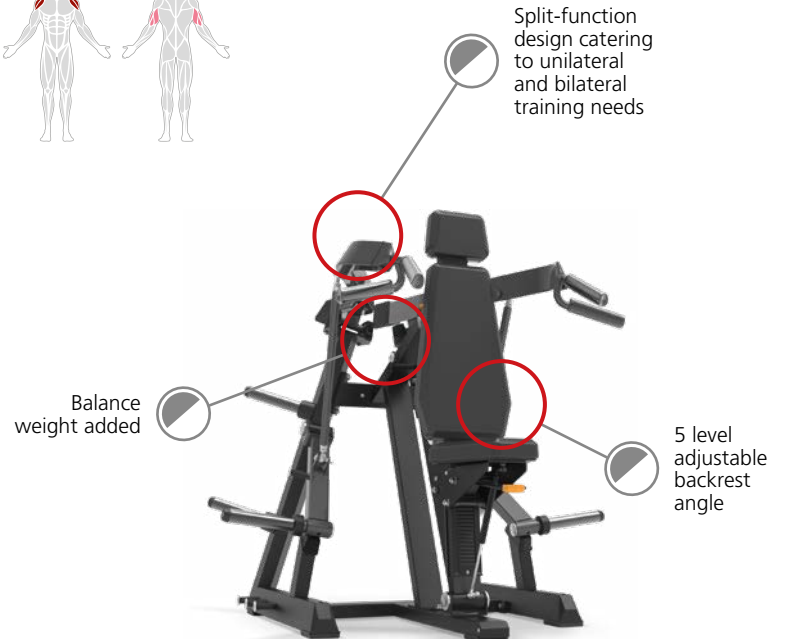
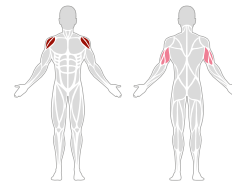

SPECIFICATIONS

Dimensions: 163,8x151,5x145,5 cm
 NET weight: 215 kg
 Weight capacity: 200 kg
 Category: F2

ECP103

\$ 1.445,00

Standing Lateral Raise

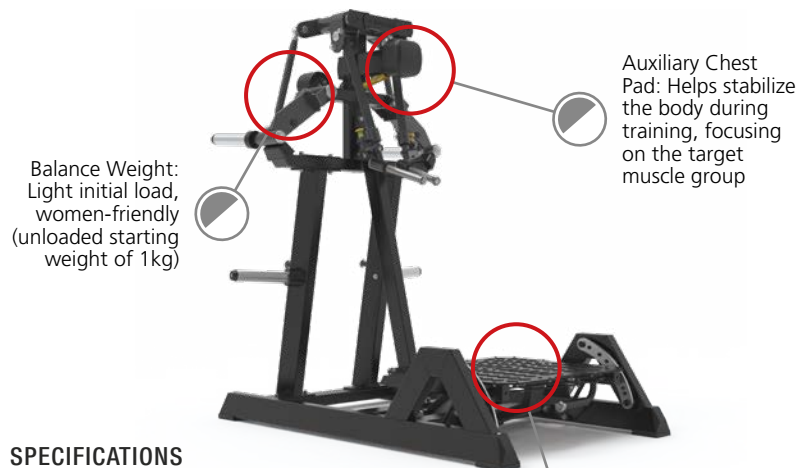
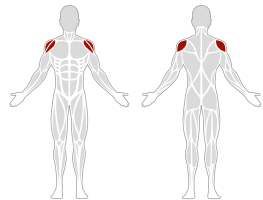

SPECIFICATIONS

Dimensions: 168,0x110,5x173,9 cm
 NET weight: 240 kg
 Weight capacity: 200 kg
 Category: F2

ECP504

\$ 1.383,00

French Press

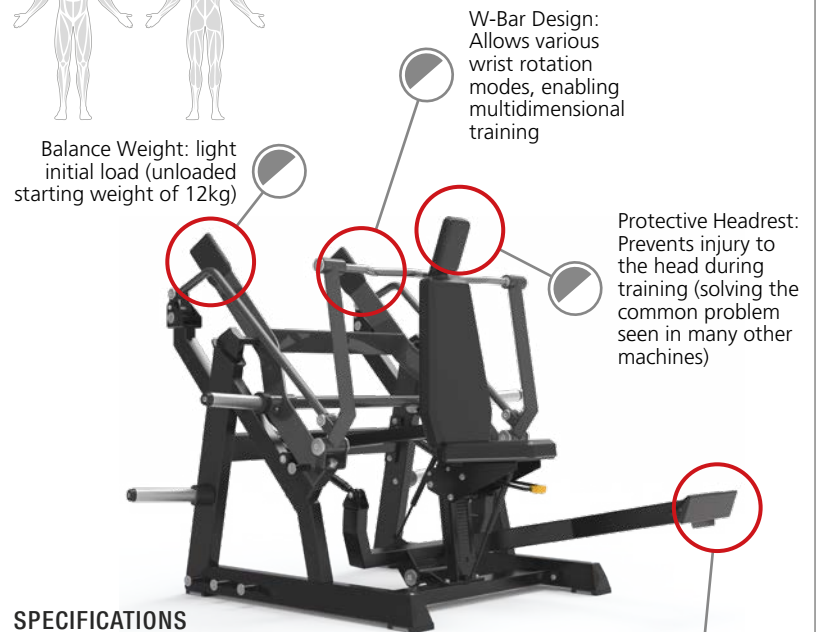
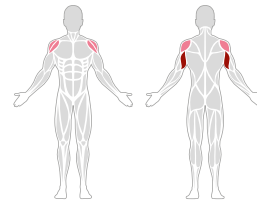

SPECIFICATIONS

Dimensions: 191,5x169,9x138,6 cm
 NET weight: 270 kg
 Weight capacity: 120 kg
 Category: F2

ECP301

\$ 1.170,00

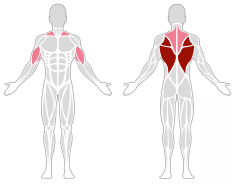

Pulldown

Split-function design caters to unilateral and bilateral training needs

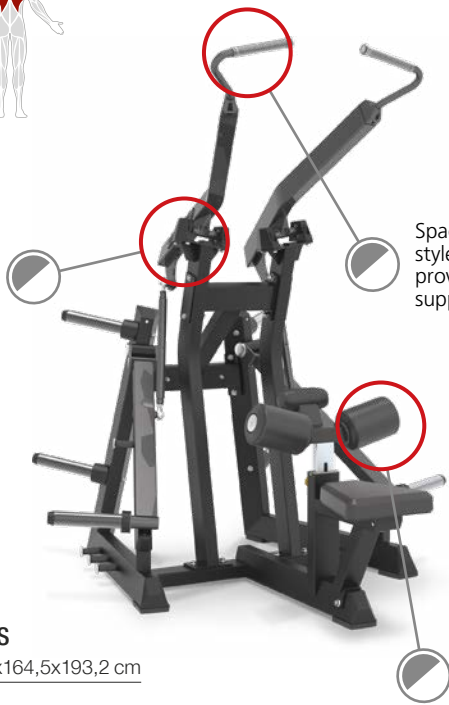

Spacious handrail-style assist handles provide better support for users

The leg foam can be adjusted in 7 levels

SPECIFICATIONS

Dimensions: 174,5x164,5x193,2 cm
 NET weight: 210 kg
 Weight capacity: 200 kg
 Category: F2

ECP306

\$ 1.645,00

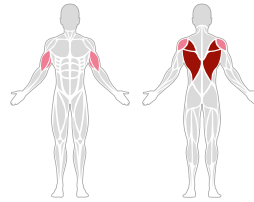

Pullover

Ergonomic Handles: Elbow support and handgrip support for training

Weight Adjustment Disc: Optimized strength curve for better starting and peak contraction weight



Balance Weight: Women-friendly, light initial load (starting at 2kg when unloaded)

Assisted Start: Safe position to start and end training

SPECIFICATIONS

Dimensions: 162,0x135,5x145,6 cm
 NET weight: 270 kg
 Weight capacity: 120 kg
 Category: F2

ECP302

\$ 1.189,00

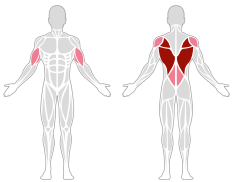

Seated Row

Spacious handrail-style assist handles provide better support

Dual-handle design with both overhand and underhand grips

4 level adjustable chest pad angle

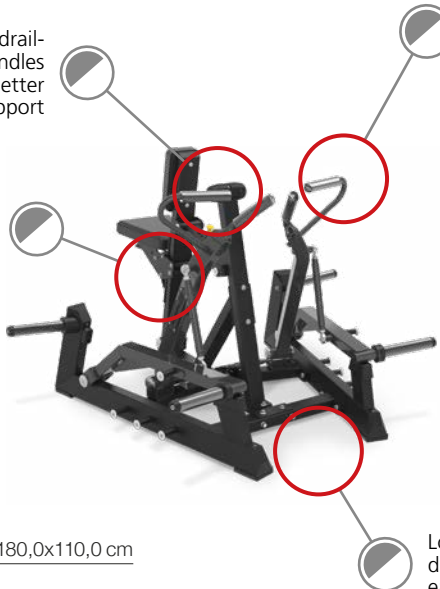

Low entry design for easy access

SPECIFICATIONS

Dimensions: 160,0x180,0x110,0 cm
 NET weight: 190 kg
 Weight capacity: 120 kg
 Category: F2

ECP501

\$ 1.007,00

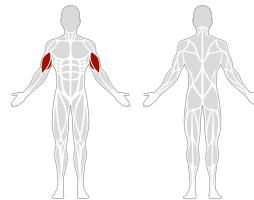

Seated Biceps

Hidden Weight Adjustment Disc: Adjusts the resistance to match the bicep muscle strength curve

W-Bar Design: Allows various modes of wrist rotation and neutral positioning for multidimensional bicep training. The aluminum W-bar minimizes after sales repair costs and reduces the initial training weight

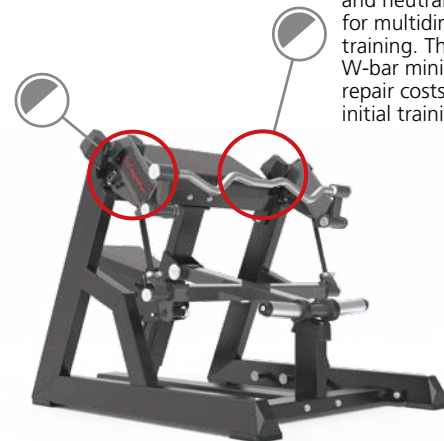

SPECIFICATIONS

Dimensions: 135,5x108,8x97,0 cm
 NET weight: 140 kg
 Weight capacity: 100 kg
 Category: F2

ECP625
\$ 1.440,00

Kneel Glute Kickback

Adjustable Track: Three adjustable angles (45/60/80°) for targeted glute and hamstring training. Equipped with an air cylinder for easy adjustment

Adjustable chest pad ensures stability during training

Light Start Load: Unloaded starting weight of 15.5kg

Adjustable footrest and elbow pad to accommodate users of different heights and starting positions

SPECIFICATIONS
Dimensions: 198,0x125,5x182,0 cm
NET weight: 230 kg
Weight capacity: 100 kg
Category: F2

ECP713
\$ 1.885,00

Squat

Convenient dual-sided handle adjustments

Balance weight added

Adjustable foot pedal angle with six settings and a spacious platform (750x665mm)

SPECIFICATIONS
Dimensions: 230,0x126,0x179,0 cm
NET weight: 330 kg
Weight capacity: 400 kg
Category: F2

ECP617
\$ 1.900,00

Hack Squat

Dual-purpose design with both shoulder and waist carrying options

Adjustable safety limit to effectively protect users

Adjustable foot pedal angle with 4 levels from 35° to 50°

SPECIFICATIONS
Dimensions: 218,5x129,0x141,6 cm
NET weight: 315 kg
Weight capacity: 400 kg
Category: F2

ECP605
\$ 1.270,00

Seated Leg Extension

Three starting position adjustments to accommodate various training angles and ease of use

Detachable seat cushion for lower after-sales cost

Adjustable tibia pad (5 positions) and backrest to cater to different height users

SPECIFICATIONS
Dimensions: 172,7x131,4x110,0 cm
NET weight: 210 kg
Weight capacity: 200 kg
Category: F2

ECP604

\$ 925,00

Prone Leg Curl

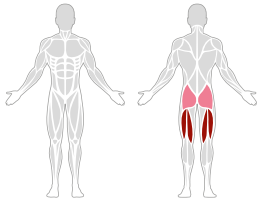

Adjustable Leg Pad: Adjustable for different heights and starting positions

Dual Position Handles: Suitable for users of different heights

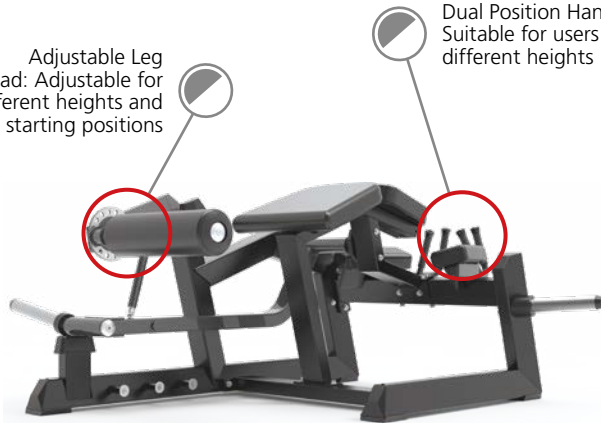

SPECIFICATIONS

Dimensions: 175,1x160,7x78,8 cm
 NET weight: 180 kg
 Weight capacity: 150 kg
 Category: F2

ECP401

\$ 1.082,00

Abdominal

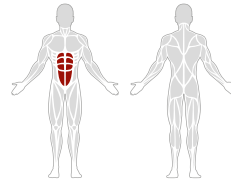

Free-Style Seat: The seat can be used for fixed abdominal oblique training or free-style abdominal oblique exercises



SPECIFICATIONS

Dimensions: 168,5x109,5x172,1 cm
 NET weight: 180 kg
 Weight capacity: 120 kg
 Category: F2

ECP721

\$ 1.805,00

Smith

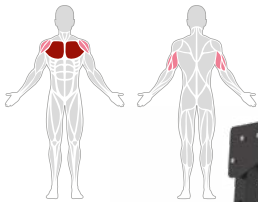

Adjustable safety hook height for secure training

Low Starting Position: Minimum starting height of 33cm

150mm adjustable spacing, meeting various training needs



SPECIFICATIONS

Dimensions: 224,2x136,8x223,2 cm
 NET weight: 330 kg
 Weight capacity: 250 kg
 Category: F2

Product Advantages: The only Smith machine that allows vertical and 7° angle switching

in impulse

FE Line

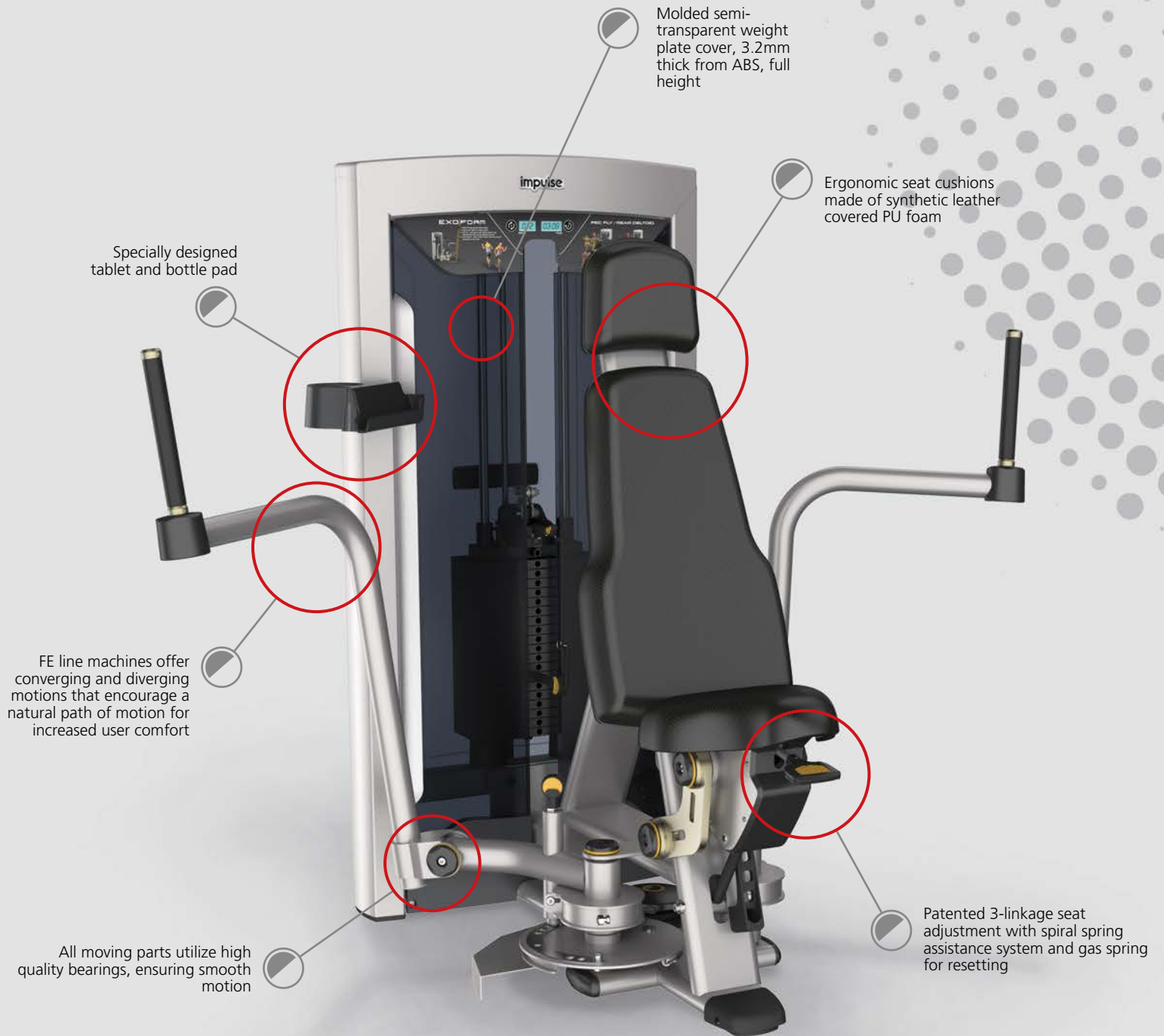

Molded semi-transparent weight plate cover, 3.2mm thick from ABS, full height

Ergonomic seat cushions made of synthetic leather covered PU foam

Specially designed tablet and bottle pad

FE line machines offer converging and diverging motions that encourage a natural path of motion for increased user comfort

All moving parts utilize high quality bearings, ensuring smooth motion

Patented 3-linkage seat adjustment with spiral spring assistance system and gas spring for resetting

Commercial-use machines combining elegant design with affordable price and an extensive list of features that allow every user to enjoy the benefits of fitness training in a safe, engaging and effective way.

The minimum 5lbs (2.25kg) change in resistance allows you to adjust the resistance exactly to your preference.

User-friendly design allows easy entry and exit

EXO|FORM

Concise and easy to read exercise placards offer a quick reference to targeted muscle groups and proper machine use, also including repetition and time counters

Ergonomically designed TPU grips with aluminum caps for a more refined look

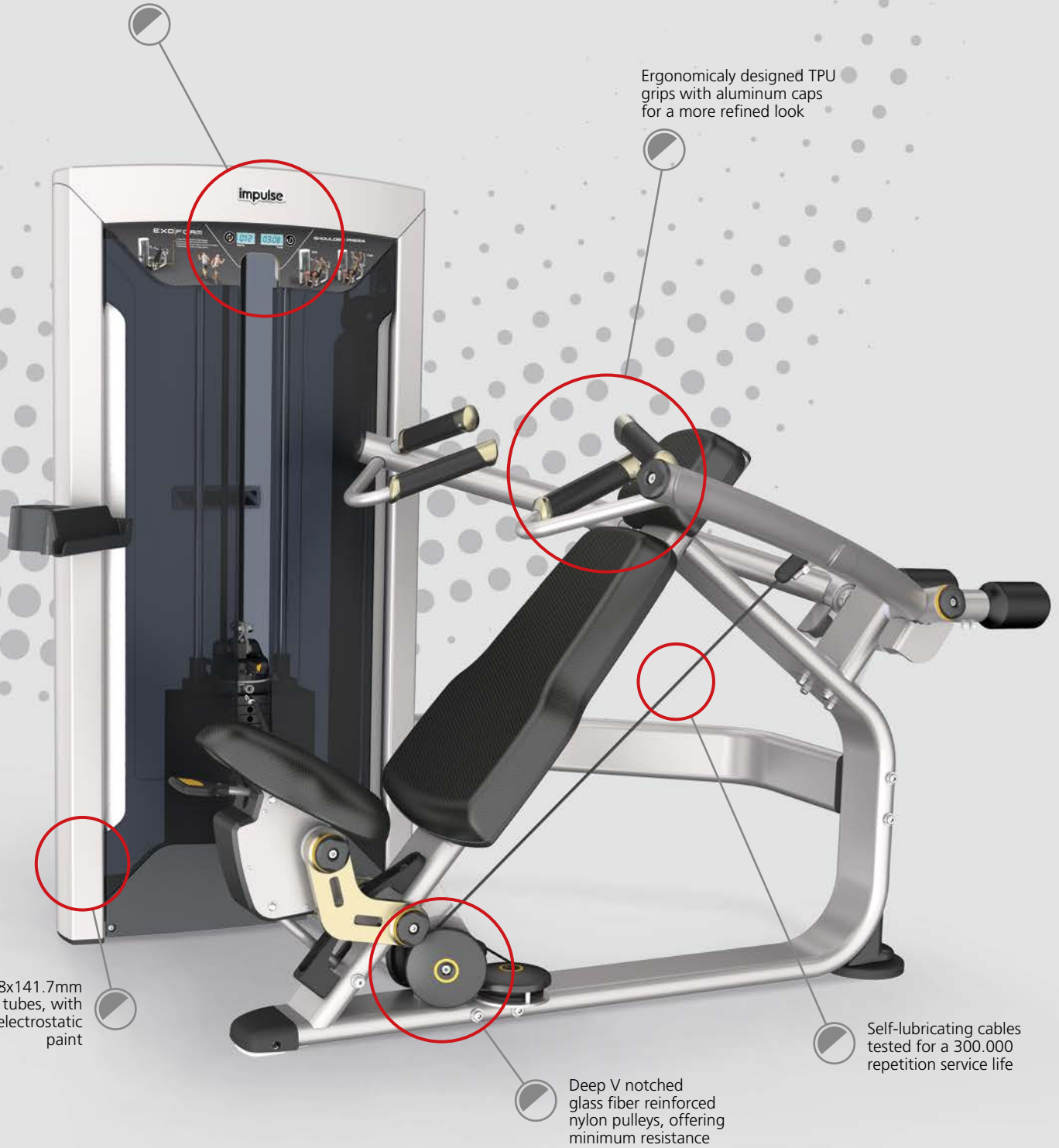

3mm thick 72.8x141.7mm main frame tubes, with double layer electrostatic paint

Deep V notched glass fiber reinforced nylon pulleys, offering minimum resistance

Self-lubricating cables tested for a 300.000 repetition service life



Learn more about the FE line at www.amila.gr scan the QR-code

The weight stack is not included in the price of the machines

Muscle groups:

● Main ● Secondary

FE9701

\$ 1.799,00

Chest Press

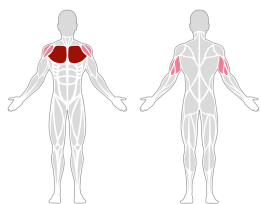

FE9701B

\$ 1.799,00



SPECIFICATIONS

Dimensions: 156,5x122,9x149,0 cm

NET weight: 170 kg

Category: F2



FE9715

\$ 1.785,00

Pec Fly / Rear Delt

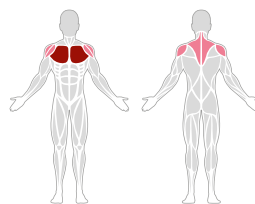

FE9715B

\$ 1.785,00



SPECIFICATIONS

Dimensions: 172,1x134,0x149,0 cm

NET weight: 161 kg

Category: F2



FE9704

\$ 2.038,00

Pectoral

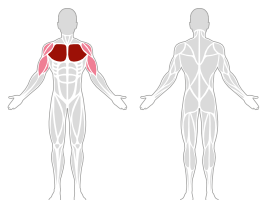

FE9704B

\$ 2.038,00



SPECIFICATIONS

Dimensions: 119,7x155,1x148,9 cm

NET weight: 166 kg

Category: F2



FE9712

\$ 1.725,00

Shoulder Press

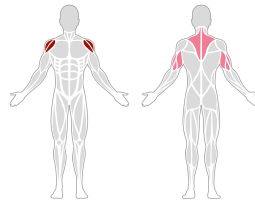

FE9712B

\$ 1.725,00



SPECIFICATIONS

Dimensions: 142,2x176,5x149,0 cm

NET weight: 169 kg

Category: F2



FE9723

\$ 1.722,00

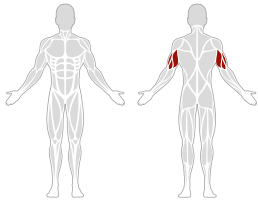

Tricep



FE9723B

\$ 1.722,00

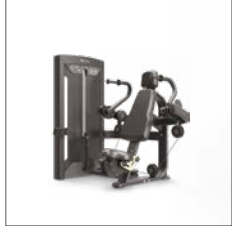

SPECIFICATIONS

Dimensions: 158,0x114,9x149,0 cm

NET weight: 164 kg

Category: F2

FE9720

\$ 1.986,00

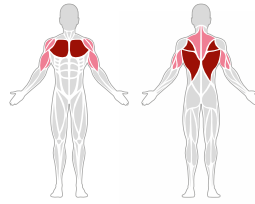

Weight Assisted Chin / Dip Combo



FE9720B

\$ 1.986,00

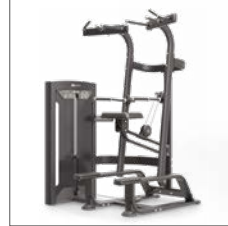

SPECIFICATIONS

Dimensions: 175,0x138,0x219,8 cm

NET weight: 244 kg

Category: F2

FE9724

\$ 2.275,00

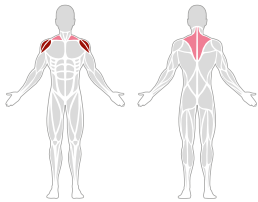

Lateral Raise



FE9724B

\$ 2.275,00

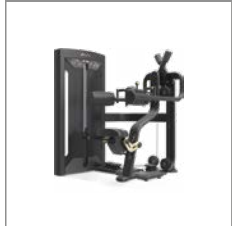

SPECIFICATIONS

Dimensions: 126,6x126,1x149,1 cm

NET weight: 187 kg

Category: F2

FE9702

\$ 1.725,00

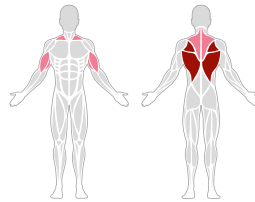

Lat Pulldown



FE9702B

\$ 1.725,00

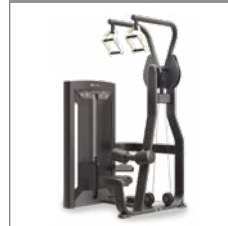

SPECIFICATIONS

Dimensions: 130,4x122,6x210,9 cm

NET weight: 177 kg

Category: F2

Row

FE9719

\$ 1.822,00

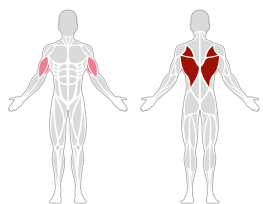

FE9719B

\$ 1.822,00



SPECIFICATIONS

Dimensions: 112,7x199,6x149,2 cm

NET weight: 175 kg

Category: F2



Arm Curl

FE9703

\$ 1.786,00

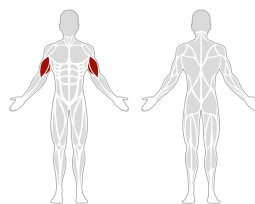

FE9703B

\$ 1.786,00



SPECIFICATIONS

Dimensions: 156,7x114,9x149,0 cm

NET weight: 170 kg

Category: F2



Abdominal

FE9714

\$ 1.406,50

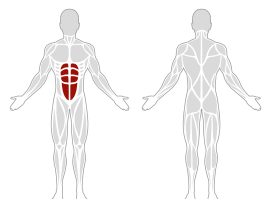

FE9714B

\$ 1.406,50



SPECIFICATIONS

Dimensions: 120,2x138,3x149,0 cm

NET weight: 142 kg

Category: F2



Back Extension

FE9732

\$ 1.643,00

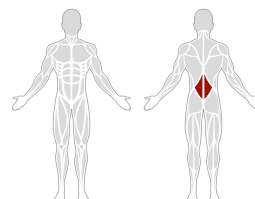

FE9732B

\$ 1.643,00



SPECIFICATIONS

Dimensions: 122,3x138,3x148,9 cm

NET weight: 185 kg

Category: F2



FE9718

\$ 2.328,00

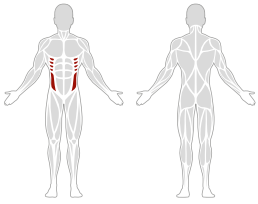

Torso Rotation

Όργανο Ενδυνάμωσης Πλάγιων Κοιλιακών

FE9705

\$ 1.712,00

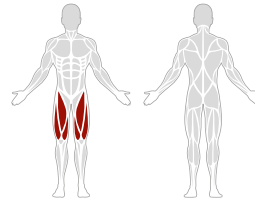

Leg Extension

FE9718B

\$ 2.328,00



FE9705B

\$ 1.712,00

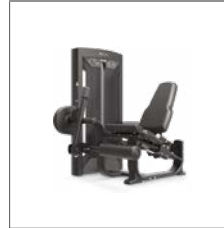

ΠΡΟΔΙΑΓΡΑΦΕΣ

Διαστάσεις: 119,0x114,9x150,6 cm
Καθαρό βάρος: 151 kg
Κατηγορία: Φ2

SPECIFICATIONS

Dimensions: 124,0x149,2x149,0 cm
NET weight: 170 kg
Category: F2

FE9726

\$ 1.578,00

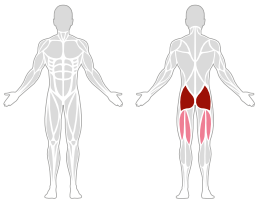

Glute

Όργανο Ενδυνάμωσης Γλουτών

FE9708

\$ 1.685,00

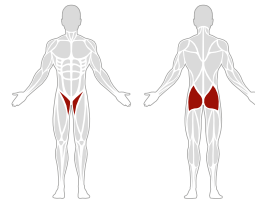

Abductor-Adductor

FE9726B

\$ 1.578,00



FE9708B

\$ 1.685,00

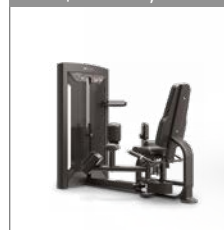

SPECIFICATIONS

Dimensions: 130,7x155,8x148,8 cm
NET weight: 168,5 kg
Category: F2

SPECIFICATIONS

Dimensions: 151,4x172,7x148,8 cm
NET weight: 166 kg
Category: F2

FE9710

\$ 2.525,00

Leg Press

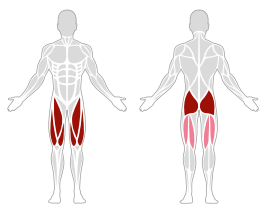

FE9710B

\$ 2.535,00

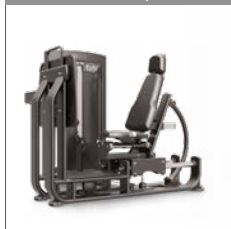

SPECIFICATIONS

Dimensions: 134,8x178,6x148,9 cm
NET weight: 279 kg
Category: F2

FE9706

\$ 1.901,00

Seated Leg Curl

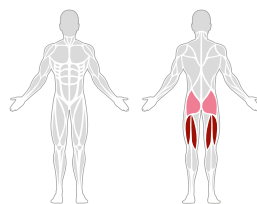

FE9706B

\$ 1.901,00



SPECIFICATIONS

Dimensions: 124,0x154,1x148,8 cm
NET weight: 184 kg
Category: F2

FE9716

\$ 1.685,00

Calf Raise

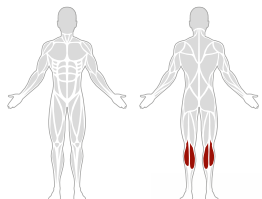

FE9716B

\$ 1.685,00



SPECIFICATIONS

Dimensions: 118,7x123,0x174,5 cm
NET weight: 168kg
Category: F2

FE9721

\$ 1.551,00

Prone Leg Curl

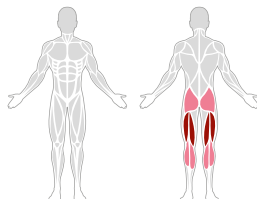

FE9721B

\$ 1.551,00



SPECIFICATIONS

Dimensions: 119,3x170,5x149,2 cm
NET weight: 154 kg
Category: F2

FE97WS200

\$ 259,00

» Weight stack:
90Kg / 200Lbs

FE97WS235

\$ 292,50

» Weight stack:
106Kg / 235Lbs

FE97WS295

\$ 366,00

» Weight stack:
134Kg / 295Lbs

Weight Stack



in impulse

IT95 Line



Concise and easy to read exercise placards offer a quick reference to targeted muscle groups and proper machine use

3mm tube in main frame and movement parts. U-frame uses 95x81.1x3 tube and functional parts use 50x100

Ergonomically designed TPU grips with aluminum caps for a more refined look

IT95 line machines offer diverging motions that allows the arm training simultaneously and alternately

The IT95 line (evolution from IT93) is the core of the strength training machines and represents its design and quality.

Their design allows easy entry and exit, considerably improves the feeling during their use, while the seat adjustment can be done while being seated.

These machines can be equipped with 4 different weight stacks, while also support incremental weight (5 lbs) for smaller adjustments.

IT95 line, with its elegant and beautiful design, high quality and many features, is available in two colors (grey and black), consisting the perfect choice for your gym.

Double stitched, with added protection cover on the back

Versatile accessory pad

The weight stack is fully covered by a polycarbonate sheet on both sides, conforming with the latest security directives and compatible with the CN directive

USA imported cable which passed more than 250 thousand times test

All moving part incorporate high quality bearings ensuring smooth motion

Lathed pulley with less tolerance



Learn more about the IT95 line at www.amila.gr scan the QR-code

Available colors:
● Grey ● Black

The weight stack is not included in the price

Muscle groups:
● Main ● Secondary

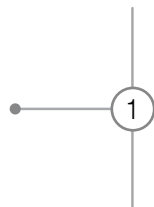

IT9525S Adjustable Hi/Lo Pulley
IT95270PTS Cable Crossover Traditional
IT9525S Adjustable Hi/Lo Pulley

IT9527S 4 Stack Multi-Station
IT95270PTS Cable Crossover Traditional
IT9525S Adjustable Hi/Lo Pulley

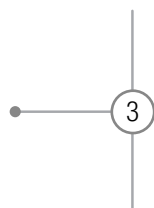
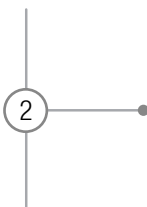

IT9527S 4 Stack Multi-Station
IT95270PTS Cable Crossover Traditional
IT9527S 4 Stack Multi-Station

IT95WS160

\$ 235,00

» Weight stack: 73Kg / 160Lbs

IT95WS200

\$ 294,00

» Weight stack: 90Kg / 200Lbs

IT95WS235

\$ 348,00

» Weight stack: 106Kg / 235Lbs

IT95WS295

\$ 437,00

» Weight stack: 134Kg / 295Lbs



Weight Stack

Πλάκες Βαρών

IT95270PTS

\$ 236,00

Cable Crossover Traditional

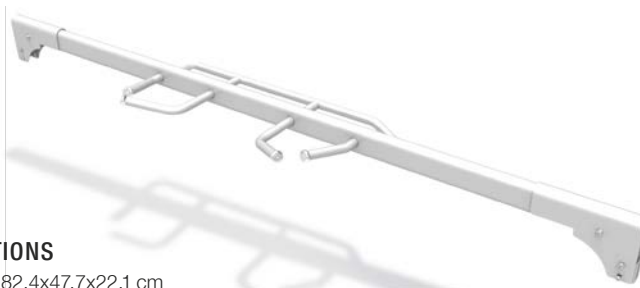

SPECIFICATIONS

Dimensions: 282,4x47,7x22,1 cm

NET weight: 27,5 kg

Category: F2

IT95270PT

\$ 236,00

Cable Crossover Traditional



SPECIFICATIONS

Dimensions: 282,4x47,7x22,1 cm

NET weight: 27,5 kg

Category: F2

IT9525

\$ 1.190,00

Adjustable Hi/Lo Pulley



IT9525S

\$ 1.190,00



SPECIFICATIONS

Dimensions: 146,3x126,2x235,8 cm
NET weight: 138 kg
Category: F2

IT9527

\$ 2.635,00

4 Stack Multi-Station



IT9527S

\$ 2.635,00



SPECIFICATIONS

Dimensions: 221,4x348,9x238,2 cm
NET weight: 309 kg
Category: F2

IT9530

\$ 1.802,00

Dual Adjustable Pulley



IT9530S

\$ 1.802,00



SPECIFICATIONS

Dimensions: 162,0x137,0x227,0 cm
NET weight: 196 kg
Category: F2

IT9501

\$ 1.240,00

Chest Press

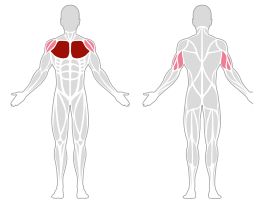

IT9501S

\$ 1.240,00



SPECIFICATIONS

Dimensions: 147,5x119,1x150,6 cm
NET weight: 128 kg
Category: F2



IT9504

\$ 1.365,00

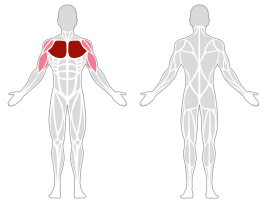

Pectoral

IT9537

\$ 1.350,00

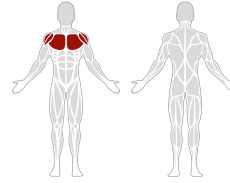

Standing Multi Flight Machine

IT9504S

\$ 1.365,00



SPECIFICATIONS

Dimensions: 144,9x136,1x150,7 cm
NET weight: 145 kg
Category: F2

IT9504S

\$ 1.350,00



SPECIFICATIONS

Dimensions: 145,5x90,6x186,3 cm
NET weight: 270 kg
Category: F2

IT9515

\$ 1.173,00

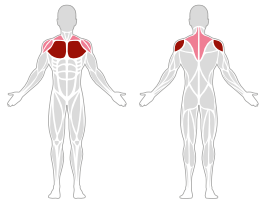

Pec Fly / Rear Delt

IT9517

\$ 1.342,00

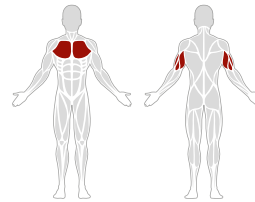

Dip Press

IT9515S

\$ 1.173,00



SPECIFICATIONS

Dimensions: 127,5x127,1x204,8 cm
NET weight: 124 kg
Category: F2

IT9517S

\$ 1.342,00



SPECIFICATIONS

Dimensions: 123,3x169,4x150,6 cm
NET weight: 143 kg
Category: F2

IT9520

\$ 1.355,00

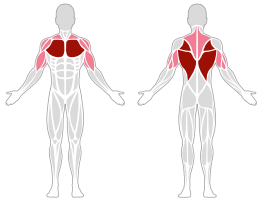

Weight Assisted Chin / Dip Combo



IT9520S

\$ 1.355,00



SPECIFICATIONS

Dimensions: 157,3x131,5x228,6 cm
NET weight: 171 kg
Category: F2

IT9522

\$ 1.167,00

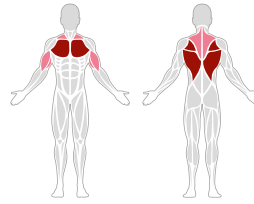

Lat Pulldown / Vertical Row



IT9522S

\$ 1.167,00



SPECIFICATIONS

Dimensions: 122,3x189,7x222,8 cm
NET weight: 120 kg
Category: F2

IT9529

\$ 1.422,00

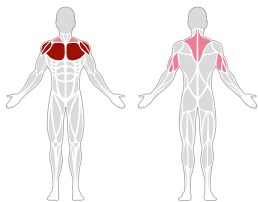

Multi Press



IT9529S

\$ 1.422,00

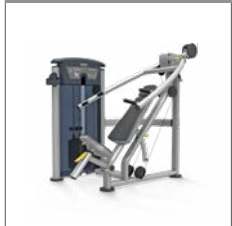

SPECIFICATIONS

Dimensions: 143,7x182,7x166,9 cm
NET weight: 166 kg
Category: F2

IT9533

\$ 1.245,00

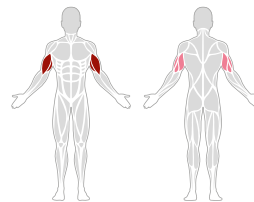

Bicep / Tricep



IT9533S

\$ 1.245,00



SPECIFICATIONS

Dimensions: 122,5x130,0x150,6 cm
NET weight: 132 kg
Category: F2

IT9503

\$ 1.064,00

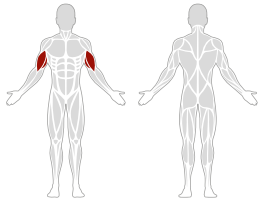

Arm Curl

IT9502

\$ 1.258,00

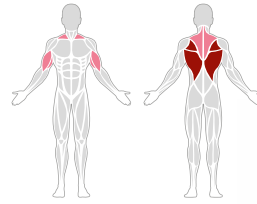

Lat Pull

IT9503S

\$ 1.064,00



SPECIFICATIONS

Dimensions: 120,8x122,5x150,7 cm
NET weight: 116 kg
Category: F2

IT9502S

\$ 1.258,00

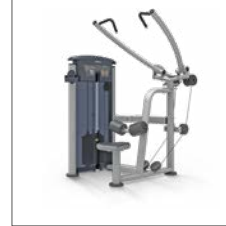

SPECIFICATIONS

Dimensions: 138,0x143,4x188,9 cm
NET weight: 148 kg
Category: F2

IT9519

\$ 1.266,00

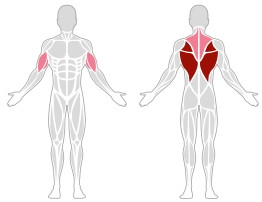

Row

IT9512

\$ 1.249,00

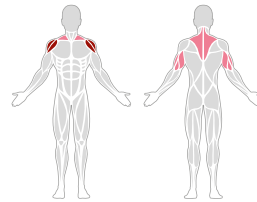

Shoulder Press

IT9519S

\$ 1.266,00



SPECIFICATIONS

Dimensions: 126,4x161,6x150,6 cm
NET weight: 127 kg
Category: F2

IT9512S

\$ 1.249,00

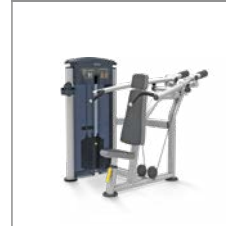

SPECIFICATIONS

Dimensions: 144,3x156,0x151,0 cm
NET weight: 137 kg
Category: F2

IT9524

\$ 1.056,00

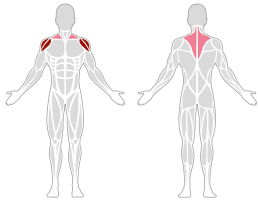

Lateral Raise

IT9514

\$ 1.048,00

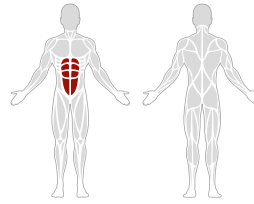

AB Machine

IT9524S

\$ 1.056,00



IT9514S

\$ 1.048,00

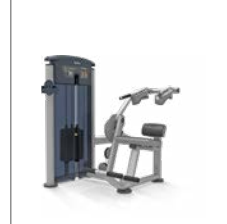

SPECIFICATIONS

Dimensions: 121,3x122,2x150,6 cm
NET weight: 128 kg
Category: F2

SPECIFICATIONS

Dimensions: 114,8x134,6x158,1 cm
NET weight: 113 kg
Category: F2

IT9518

\$ 1.128,00

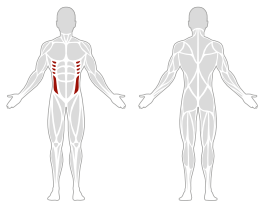

Torso Rotation

IT9534

\$ 1.270,00

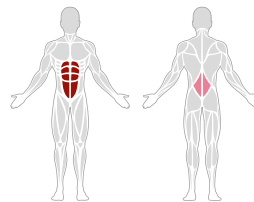

Abdominal / Back Extension

IT9518S

\$ 1.128,00



IT9534S

\$ 1.270,00



SPECIFICATIONS

Dimensions: 119,0x114,9x150,6 cm
NET weight: 151 kg
Category: F2

SPECIFICATIONS

Dimensions: 118,9x119,6x150,6 cm
NET weight: 139 kg
Category: F2

Back Extension

IT9532

\$ 1.055,00

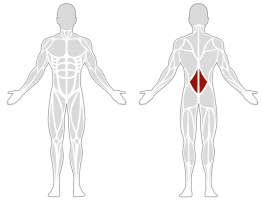

IT9532S

\$ 1.055,00



SPECIFICATIONS

Dimensions: 118,9x123,3x150,6 cm

NET weight: 124 kg

Category: F2



Abductor and Adductor

IT9508

\$ 1.190,00

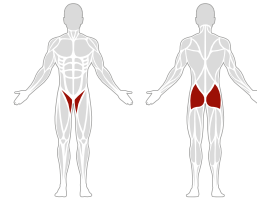

IT9508S

\$ 1.190,00

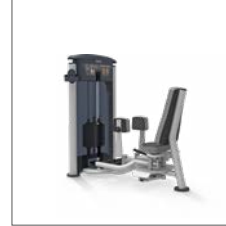

SPECIFICATIONS

Dimensions: 89,7x155,3x150,6 cm

NET weight: 150 kg

Category: F2



Glute

IT9526

\$ 1.188,00

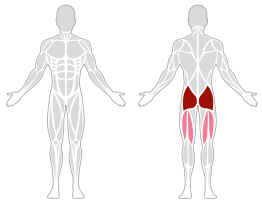

IT9526S

\$ 1.188,00



SPECIFICATIONS

Dimensions: 121,7x161,5x150,6 cm

NET weight: 124 kg

Category: F2



Prone Leg Curl

IT9521

\$ 1.096,00

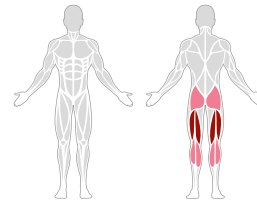

IT9521S

\$ 1.096,00



SPECIFICATIONS

Dimensions: 114,5x145,8x150,6 cm

NET weight: 132 kg

Category: F2



IT9510

\$ 1.865,00

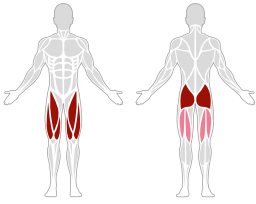

Leg Press

IT9528

\$ 1.422,00

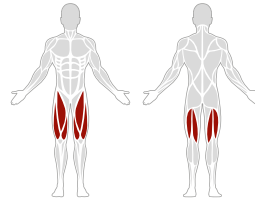

Leg Extension / Leg Curl

IT9510S

\$ 1.865,00



SPECIFICATIONS

Dimensions: 113,7x185,0x150,6 cm
NET weight: 211 kg
Category: F2

IT9528S

\$ 1.422,00

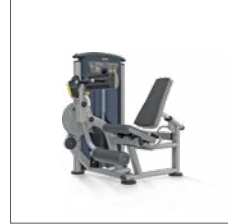

SPECIFICATIONS

Dimensions: 123,0x137,5x150,6 cm
NET weight: 167 kg
Category: F2

IT9539

\$ 1.616,00

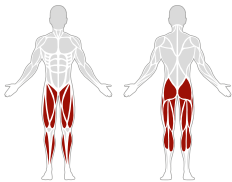

Seated Leg Press Hack Squat

IT9538

\$ 925,00

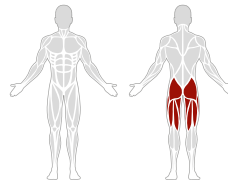

Hip Thrust

IT9539S

\$ 1.616,00



SPECIFICATIONS

Dimensions: 185,7x109,0x150,6 cm
NET weight: 325 kg
Category: F2

IT9538S

\$ 925,00

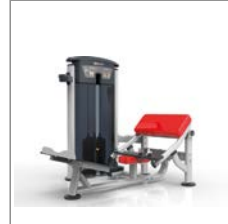

SPECIFICATIONS

Dimensions: 156,3x129,0x150,6 cm
NET weight: 255 kg
Category: F2

IT9505

\$ 1.174,00

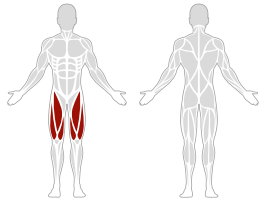

Leg Extension

IT9506

\$ 1.300,00

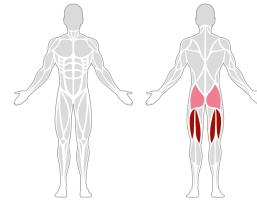

Seated Leg Curl

IT9505S

\$ 1.174,00



SPECIFICATIONS

Dimensions: 118,5x122,0x150,6 cm
NET weight: 133 kg
Category: F2

IT9506S

\$ 1.300,00



SPECIFICATIONS

Dimensions: 118,6x153,6x150,6 cm
NET weight: 150 kg
Category: F2

IT9516

\$ 1.080,00

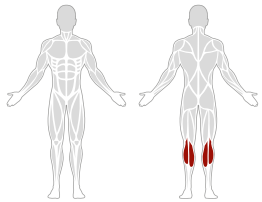

Calf Raise

IT9509

\$ 1.295,00

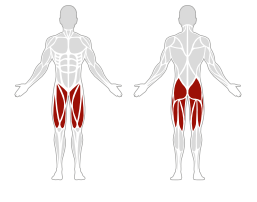

Total Hip

IT9516S

\$ 1.080,00



SPECIFICATIONS

Dimensions: 115,6x128,7x173,9 cm
NET weight: 128 kg
Category: F2

IT9509S

\$ 1.295,00



SPECIFICATIONS

Dimensions: 129,2x97,2x150,6 cm
NET weight: 148 kg
Category: F2

in impulse

IF93 Line



Impulse's IF93 line is designed with simple clear lines and is ideal for small gyms and clubs.

It is inexpensive to own, easy to maintain, while offering a wide range of exercises.

The clear and precise instructions and training tips are great for individuals who are new to strength training and help users to build targeted muscles

The main frame is coated with materials that are environmental friendly, helping to improve the product's quality and provide good scratching and corrosion resistance



The upright tubing thickness of 2.5mm and the functional parts with rectangular tube at size of 50x100x2.5mm make IF93 stronger and with high endurance

Ergonomic seat cushions, chest and back pads are made of polymer materials; the specially designed pads have different angles, which meet various training requirements

Designed with stainless steel seat adjustment that provides a longer service life, makes it easy to adjust and looks beautiful



Learn more about the IF93 line at www.amila.gr scan the QR-code

The weight stack is not included in the price

Muscle groups:
● Main ● Secondary



IF9325
IF9327OPT
IF9325

Adjustable Hi/Lo Pulley
Cable Crossover Traditional
Adjustable Hi/Lo Pulley

IF9327
IF9327OPT
IF9325

4 Stack Multi-Station
Cable Crossover Traditional
Adjustable Hi/Lo Pulley

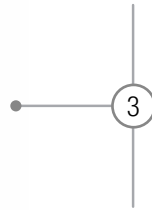
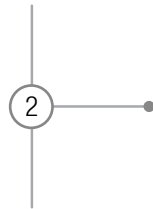

IF9327
IF9327OPT
IF9327

4 Stack Multi-Station
Cable Crossover Traditional
4 Stack Multi-Station

IF9327OPT

\$ 110,70

Cable Crossover Traditional



SPECIFICATIONS

Dimensions: 250,5x44,1x19,8 cm

NET weight: 21,5 kg

Category: F2

IF9330

\$ 1.230,00

Dual Adjustable Pulley



SPECIFICATIONS

Dimensions: 163,9x88,2x227,0 cm

NET weight: 117 kg

Category: F2

IF93WS160

\$ 215,20

» Weight: 73Kg/160Lbs

IF93WS200

\$ 264,00

» Weight: 90Kg/200Lbs

IF93WS235

\$ 312,00

» Weight: 106Kg/235Lbs

IF93WS295

\$ 399,00

» Weight: 134Kg/295Lbs



Weight Stack

IF9325

\$ 602,00

Adjustable Hi/Lo Pulley



SPECIFICATIONS

Dimensions: 144,9x125,8x233,8 cm
 NET weight: 96 kg
 Category: F2

IF9327

\$ 1.635,00

4 Stack Multi-Station



SPECIFICATIONS

Dimensions: 244,5x342,7x233,8 cm
 NET weight: 257 kg
 Category: F2

IF9301

\$ 822,00

Chest Press

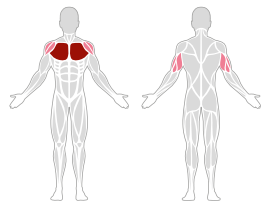

SPECIFICATIONS

Dimensions: 136,0x118,8x153,0 cm
 NET weight: 97,1 kg
 Category: F2

IF9304

\$ 872,00

Pectoral

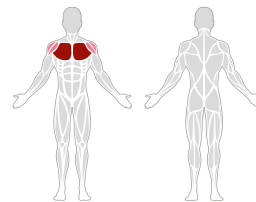

SPECIFICATIONS

Dimensions: 173,6x80,6x153,0 cm
 NET weight: 95 kg
 Category: F2

IF93 15

\$ 872,00

Pectoral

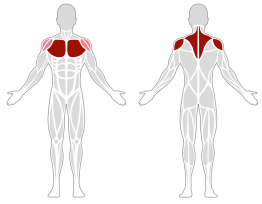

SPECIFICATIONS

Dimensions: 149,3x142,1x186,3 cm
NET weight: 90 kg
Category: F2

IF93 20

\$ 855,80

Weight Assisted Chin / Dip Combo

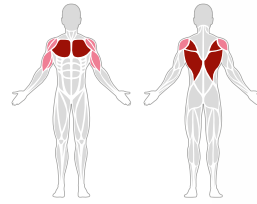

SPECIFICATIONS

Dimensions: 130,9x125,6x249,8 cm
NET weight: 107 kg
Category: F2

IF93 29

\$ 1.090,00

Multi-Press

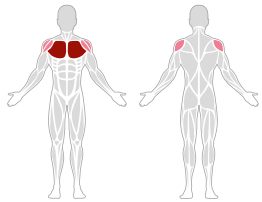

SPECIFICATIONS

Dimensions: 144,6x202,6x153,0 cm
NET weight: 97,5 kg
Category: F2

IF93 24

\$ 730,00

Lateral Raise

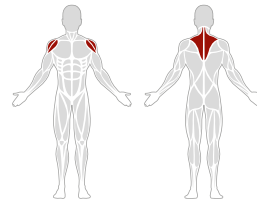

SPECIFICATIONS

Dimensions: 75,0x119,7x153,0 cm
NET weight: 85 kg
Category: F2

IF9312

\$ 810,00

Shoulder Press

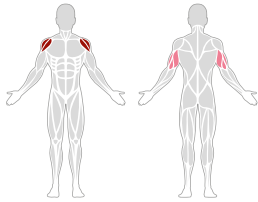

SPECIFICATIONS

Dimensions: 145,6x145,0x153,0 cm
NET weight: 103 kg
Category: F2

IF9303

\$ 701,00

Arm Curl

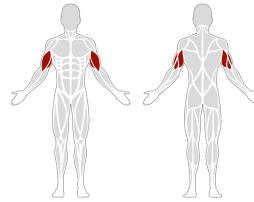

SPECIFICATIONS

Dimensions: 102,8x121,6x153,0 cm
NET weight: 90 kg
Category: F2

IF9333

\$ 924,00

Bicep Curl / Tricep Extension

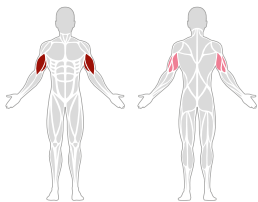

SPECIFICATIONS

Dimensions: 120,3x132,7x153,0 cm
NET weight: 110 kg
Category: F2

IF9317

\$ 814,20

Seated Dip

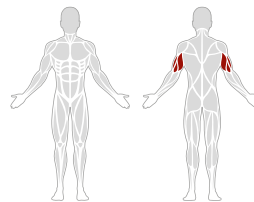

SPECIFICATIONS

Dimensions: 121,2x122,7x153,0 cm
NET weight: 97,5 kg
Category: F2

IF9302

\$ 802,00

Lat Pulldown

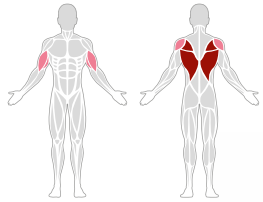

SPECIFICATIONS

Dimensions: 131,8x158,3x189,1 cm
NET weight: 100 kg
Category: F2

IF9319

\$ 791,50

Vertical Row

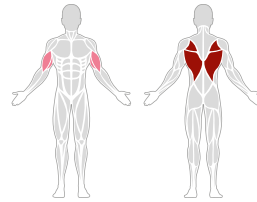

SPECIFICATIONS

Dimensions: 85,8x180,4x153,0 cm
NET weight: 91,5 kg
Category: F2

IF9322

\$ 934,00

Lat Pulldown

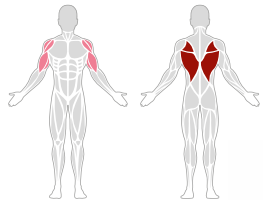

SPECIFICATIONS

Dimensions: 122,3x188,6x222,7 cm
NET weight: 91 kg
Category: F2

IF9318

\$ 828,00

Torso Rotation

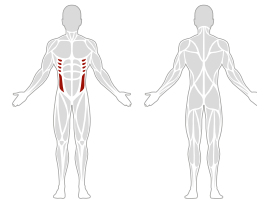

SPECIFICATIONS

Dimensions: 124,0x110,3x153,0 cm
NET weight: 96 kg
Category: F2

IF9314

\$ 735,00

Abdominal

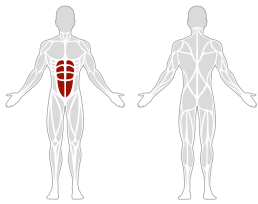

SPECIFICATIONS

Dimensions: 100,8x108,5x153,0 cm
NET weight: 89,5 kg
Category: F2

IF9334

\$ 1.046,00

Ab / Back

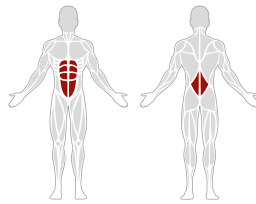

SPECIFICATIONS

Dimensions: 159.2x125.3x153.1 cm
NET weight: **, * kg
Category: F2

IF9332

\$ 794,00

Back Extension

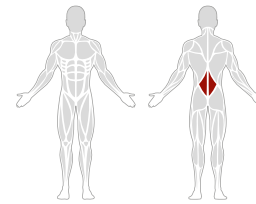

SPECIFICATIONS

Dimensions: 103,4x112,0x153,0 cm
NET weight: 98 kg
Category: F2

IF9335

\$ 839,00

Abductor

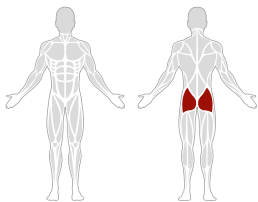

SPECIFICATIONS

Dimensions: 94,6x158,3x153,0 cm
NET weight: 95 kg
Category: F2

IF9326

\$ 727,00

Kick Back

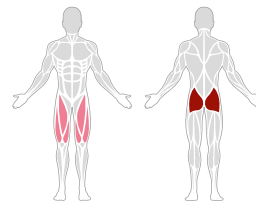

SPECIFICATIONS

Dimensions: 106,8x103,4x153,0 cm
NET weight: 90 kg
Category: F2

IF9308

\$ 988,50

Abductor / Adductor

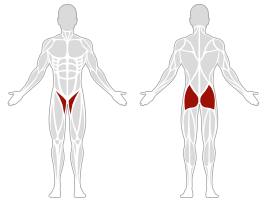

SPECIFICATIONS

Dimensions: 93,5x157,0x153,0 cm

NET weight: 103 kg

Category: F2

IF9305

\$ 810,00

Leg Extension

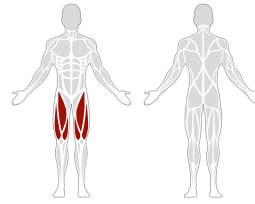

SPECIFICATIONS

Dimensions: 104,8x114,6x153,0 cm

NET weight: 102 kg

Category: F2

IF9306

\$ 912,10

Seated Leg Curl

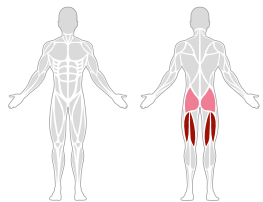

SPECIFICATIONS

Dimensions: 103,4x144,8x153,0 cm

NET weight: 95 kg

Category: F2

IF9316

\$ 791,00

Calf Raise

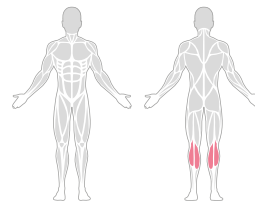

SPECIFICATIONS

Dimensions: 110,5x115,0x177,5 cm

NET weight: 106 kg

Category: F2

IF9328

\$ 1.110,00

Leg Extension / Leg Curl

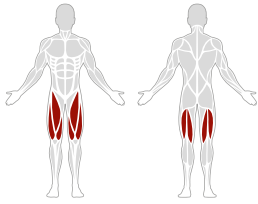

SPECIFICATIONS

Dimensions: 127,0x127,2x153,0 cm
NET weight: 105 kg
Category: F2

IF9321

\$ 805,50

Prone Leg Curl

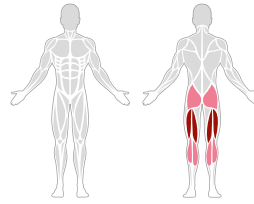

SPECIFICATIONS

Dimensions: 114,6x150,7x153,0 cm
NET weight: 102 kg
Category: F2

IF9336

\$ 840,00

Adductor

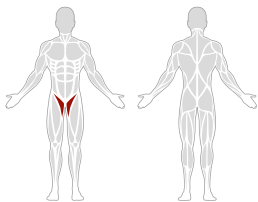

SPECIFICATIONS

Dimensions: 118,5x158,3x153,0 cm
NET weight: 95 kg
Category: F2

IF9310

\$ 920,00

Leg Press

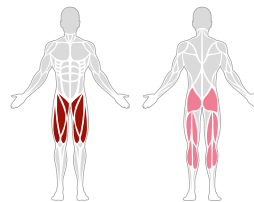

SPECIFICATIONS

Dimensions: 116,8x205,5x153,0 cm
NET weight: 121 kg
Category: F2

in impulse
IT70 Line



The Impulse IT70 line boasts high quality, commercial strength, designed to fulfill any commercial need.

Its attractive and user friendly design helps people exercise efficiently and comfortable.



Compact and durable frame from steel oval tubes

Rubber soles to protect the floor

Adjustable seating



Learn more about the IT70 line at www.amila.gr scan the QR-code

Muscle groups:
● Main ● Secondary

IT7014

\$ 508,00

Flat Bench

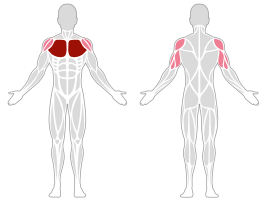

IT7014B

\$ 508,00



SPECIFICATIONS

Dimensions: 165,8x165,7x137,3 cm

NET weight: 82 kg

Category: F2

IT7015

\$ 672,00

Incline Bench

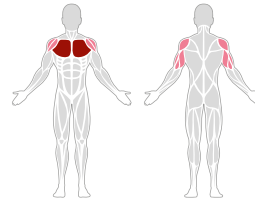

IT7015B

\$ 672,00



SPECIFICATIONS

Dimensions: 165,8x168,2x137,3 cm

NET weight: 107 kg

Category: F2

IT7016

\$ 595,00

Decline Bench

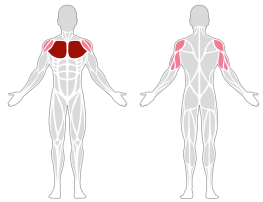

IT7016B

\$ 595,00



SPECIFICATIONS

Dimensions: 165,8x212,0x137,3 cm

NET weight: 87 kg

Category: F2

IT7019

\$ 499,00

Incline Row

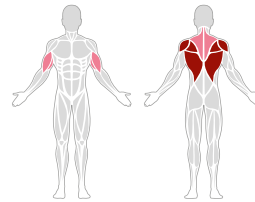

IT7019B

\$ 499,00



SPECIFICATIONS

Dimensions: 100,9x196,2x126,2 cm

NET weight: 77,5 kg

Weight capacity: 150 kg

Category: F2

IT7031

\$ 514,00

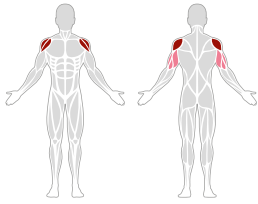

Shoulder Bench Press



IT7031B

\$ 514,00



SPECIFICATIONS

Dimensions: 134,9x112,6x165,1 cm
 NET weight: 86,5 kg
 Weight capacity: 300 kg
 Category: F2

IT7002

\$ 244,00

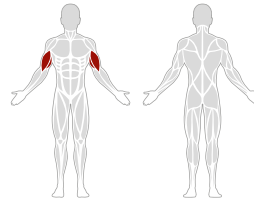

Seated Preacher Curl



IT7002B

\$ 244,00



SPECIFICATIONS

Dimensions: 80,0x95,3x88,2 cm
 NET weight: 41 kg
 Category: F2

IT7010

\$ 346,00

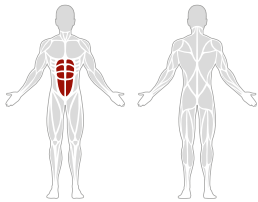

Vertical Knee Raise / Dip Stand



IT7010B

\$ 346,00



SPECIFICATIONS

Dimensions: 78,1x113,1x151,5 cm
 NET weight: 53 kg
 Category: F2

IT7010EOPT

\$ 174,00

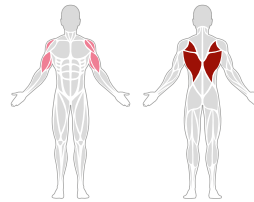

Chin-Up Accessory



IT7010EOPTB

\$ 174,00



SPECIFICATIONS

Dimensions: 70,0x93,2x235,1 cm
 NET weight: 30,5 kg
 Category: F2

Add-on accessory
 for IT7010

IT7013

\$ 358,70

Multi AB Bench

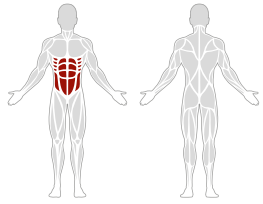

IT7013B

\$ 358,70



SPECIFICATIONS

Dimensions: 74,9x172,2x89,8 cm

NET weight: 42,5 kg

Category: F2

IT7003

\$ 418,00

AB Bench

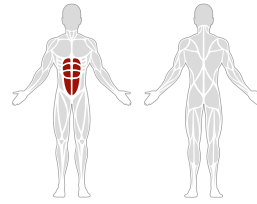

IT7003B

\$ 418,00

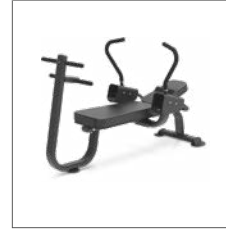

SPECIFICATIONS

Dimensions: 93,5x174,8x106,3 cm

NET weight: 57 kg

Category: F2

IT7030

\$ 236,00

Abdominal Bench

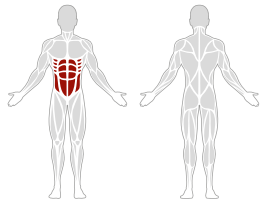

IT7030B

\$ 236,00



SPECIFICATIONS

Dimensions: 72,6x98,5x62,5 cm

NET weight: 35 kg

Category: F2

IT7007

\$ 328,00

Multi Hyperextension

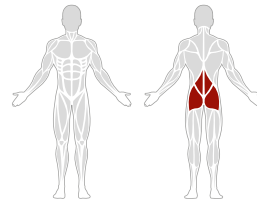

IT7007B

\$ 328,00

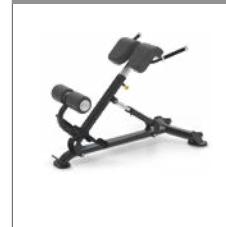

SPECIFICATIONS

Dimensions: 74,9x131,2x102,5 cm

NET weight: 43,5 kg

Category: F2

IT7006

\$ 1.194,00

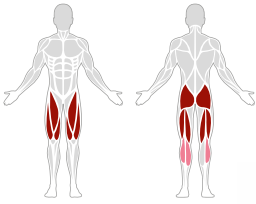

Leg Press / Hack Squat

IT7020

\$ 1.110,00

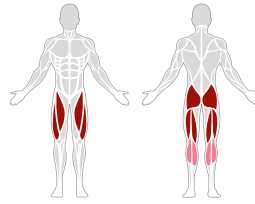

45 Leg Press

IT7006B

\$ 1.194,00



IT7020B

\$ 1.110,00



SPECIFICATIONS

Dimensions: 97,5x218,1x149,3 cm

NET weight: 166 kg

Weight capacity: 200 kg

Category: F2

SPECIFICATIONS

Dimensions: 101,6x220,5x149,4 cm

NET weight: 141 kg

Weight capacity: 200 kg

Category: F2

IT7005

\$ 305,20

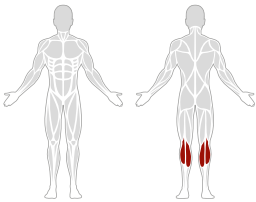

Seated Calf Raise

IT7004

\$ 242,50

Stretch

IT7005B

\$ 305,20



IT7004B

\$ 242,50

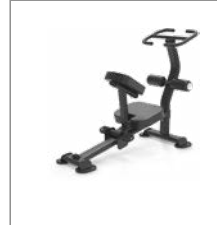

SPECIFICATIONS

Dimensions: 75,1x135,5x83,9 cm

NET weight: 50 kg

Weight capacity: 100 kg

Category: F2

SPECIFICATIONS

Dimensions: 55,2x127,4x99,7 cm

NET weight: 35 kg

Category: F2

IT7009

\$ 201,20

Flat Bench

IT7011

\$ 290,00

Multi-Adjustable Bench

IT7009B

\$ 201,20



SPECIFICATIONS

Dimensions: 74,9x120,0x42,6 cm

NET weight: 27,5 kg

Category: F2

IT7011B

\$ 290,00

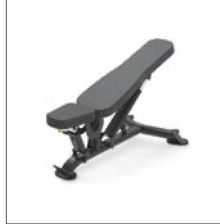

SPECIFICATIONS

Dimensions: 75,1x121,7x105,9 cm

NET weight: 40 kg

Category: F2

IT7001

\$ 1.493,00

Smith

IT7033

\$ 1.800,00

Max Rack

IT7001B

\$ 1.493,00



SPECIFICATIONS

Dimensions: 224,1x132,6x237,0 cm

NET weight: 178 kg

Weight capacity: 200 kg

Category: F2

IT7033B

\$ 1.800,00



SPECIFICATIONS

Dimensions: 211,7x148,8x218,6 cm

NET weight: 200 kg

Weight capacity: 200 kg

Category: F2

IT7012

\$ 455,00

Dumbbell Rack

For Round Dumbbells

IT7018

\$ 343,00

Dumbbell Rack

For Hexagon Dumbbells

IT7012B

\$ 455,00



IT7018B

\$ 343,00



SPECIFICATIONS

Dimensions: 158,0x81,4x98,2 cm

NET weight: 71 kg

Category: F2

SPECIFICATIONS

Dimensions: 158,0x81,4x93,8 cm

NET weight: 68 kg

Category: F2

IT7027

\$ 423,50

Barbell Rack

IT7017

\$ 216,00

Weight Plate Tree

IT7032

\$ 270,00

Olympic Bar Rack

IT7027B

\$ 423,50



IT7017B

\$ 216,00

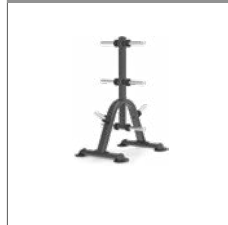

IT7032B

\$ 270,00



SPECIFICATIONS

Dimensions: 91,9x94,9x161,2 cm

NET weight: 68,5 kg

Category: F2

SPECIFICATIONS

Dimensions: 60,6x93,8x120,9 cm

NET weight: 26 kg

Category: F2

SPECIFICATIONS

Dimensions: 96,0x71,0x108,6 cm

NET weight: 47 kg

Weight capacity: 300 kg

Category: F2



ITF8 Line

The ITF8 Line is the continuation, expansion, and improvement of the well-known and popular IT70 Line. The basic philosophy remains the same: a complete line

of high-quality machines intended for heavy daily use, designed to meet the needs of the majority of gyms and studios.

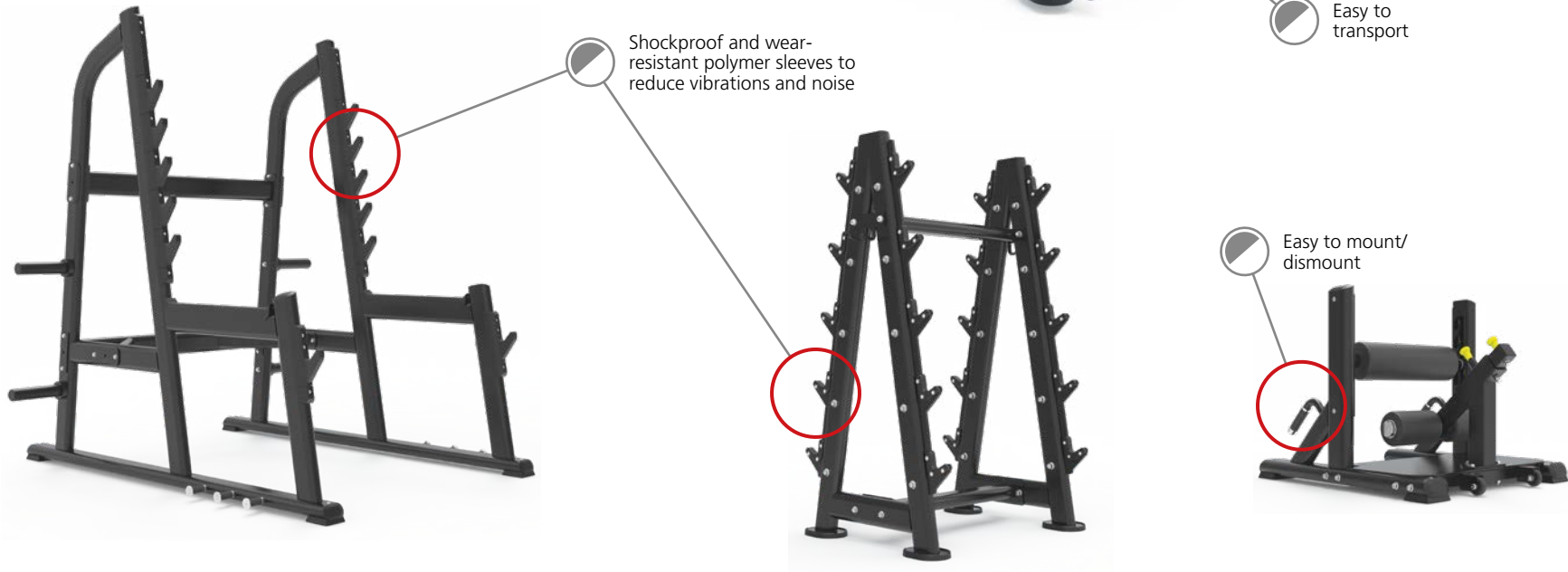
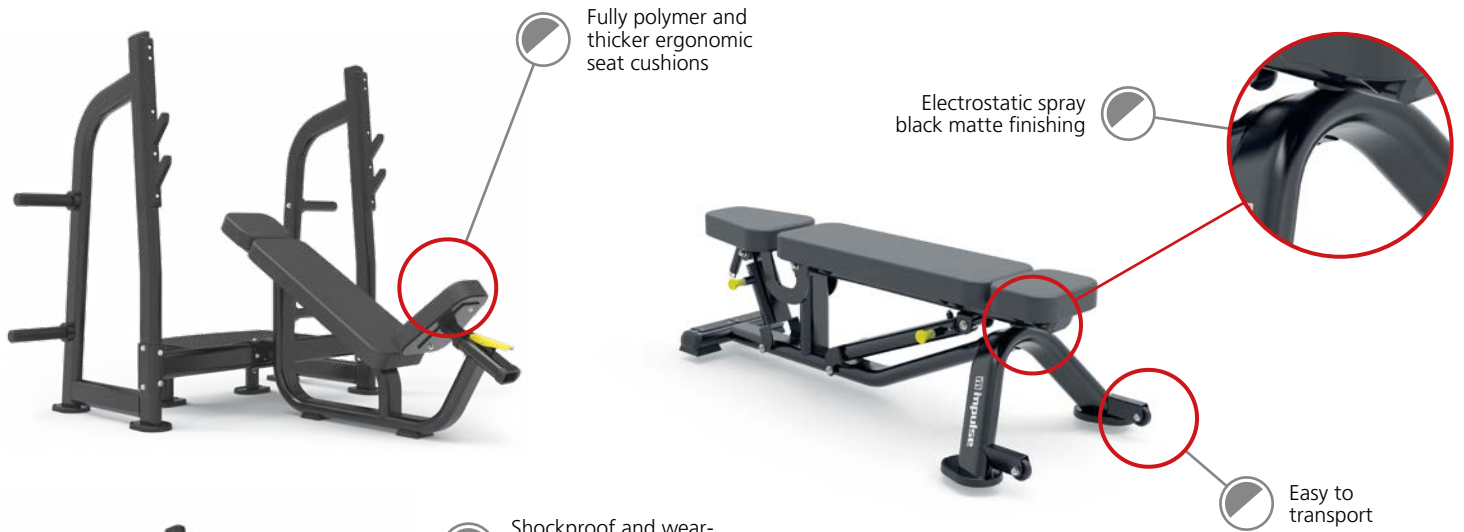

However, there are also significant changes, such as the addition of new, more specialized machines, designed to target specific muscle groups, a wide variety of benches,

as well as machines with improved features focused on performance, safety, low maintenance requirements, and a unified and harmonious overall appearance.

- » The improved welds and higher-quality paint finish, in addition to the well-known stability and durability, offer an enhanced aesthetic that will meet the needs of more modern spaces
- » The machines in this series help increase muscle mass faster and more efficiently
- » It is easier to use them in a gym with a trainer
- » They help improve athletes' posture

- » Their ergonomics are greatly improved
- » They support proper joint alignment
- » The thicker pads offer improved body support and comfort
- » They contribute to better space organization
- » Overall, the series offers the ability to perform exercises not only for general strength training but also addresses the needs of general fitness as well as specific rehabilitation cases.

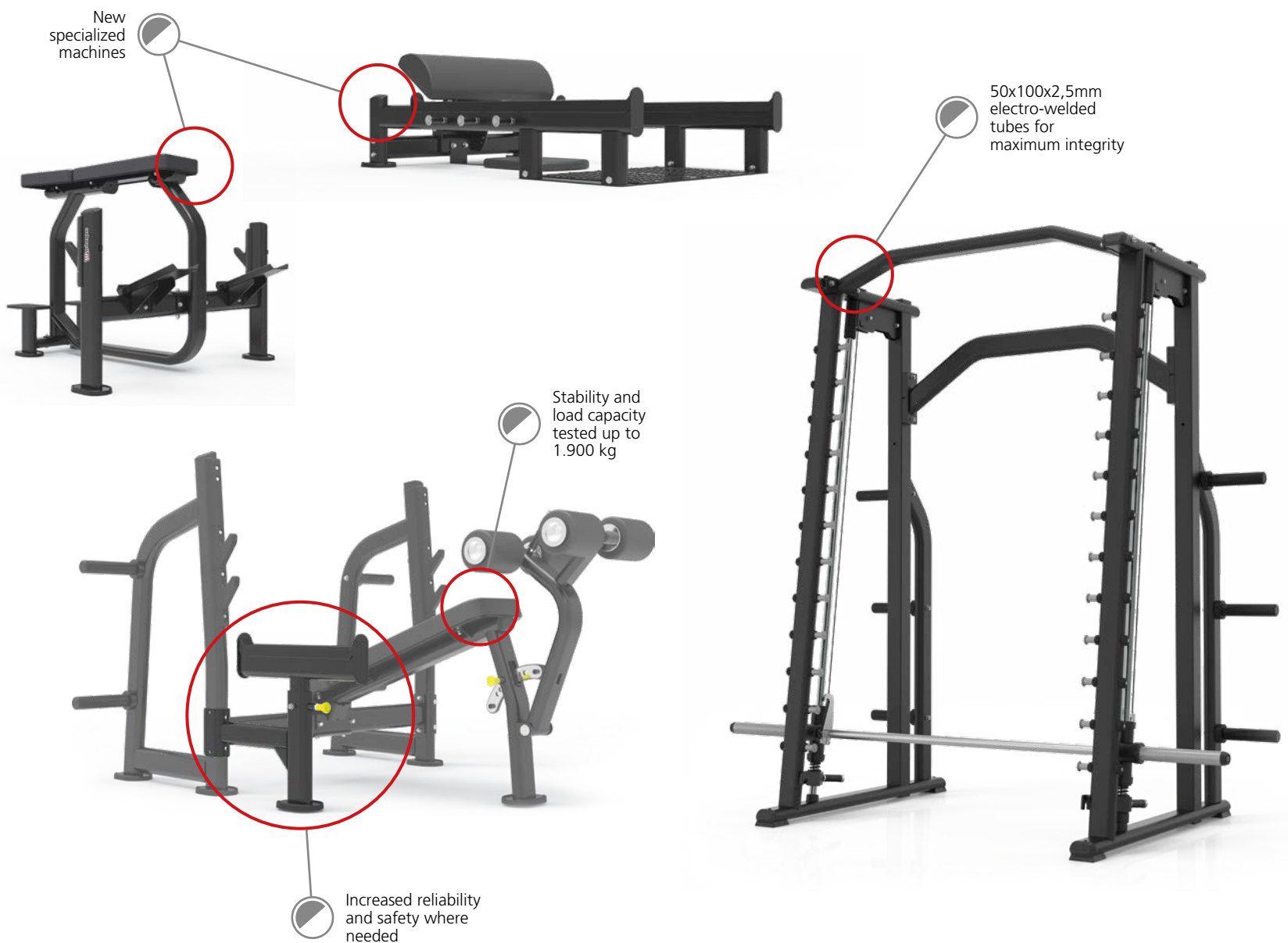

Learn more about the ITF8 line at www.amila.gr scan the QR-code

Muscle groups:
● Main ● Secondary

ITF8202

\$ 367,80

Olympic Flat Bench

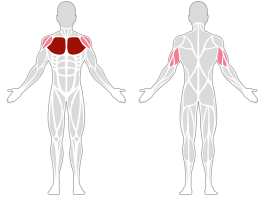

SPECIFICATIONS

Dimensions: 171,8x170,3x125,4 cm
 NET weight: 70,4 kg
 Max user weight: 150 kg
 Weight capacity: 220 kg
 Category: F2

ITF8203

\$ 536,50

Olympic Incline Bench

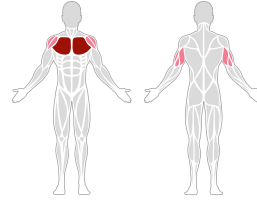

SPECIFICATIONS

Dimensions: 171,8x215,6x125,4 cm
 NET weight: 57,8 kg
 Max user weight: 150 kg
 Weight capacity: 220 kg
 Category: F2

ITF8204

\$ 491,00

Olympic Decline Bench

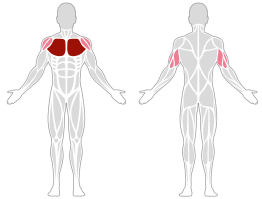

SPECIFICATIONS

Dimensions: 171,8x182,2x145,0 cm
 NET weight: 86,1 kg
 Max user weight: 150 kg
 Weight capacity: 220 kg
 Category: F2

ITF8202OPT

\$ 162,00

Safety Bar Attachment



Can only connect with ITF8202 and ITF8204



SPECIFICATIONS

Dimensions: 76,3x25,0x57,6 cm
 NET weight: 23,9 kg
 Max user weight: 150 kg
 Weight capacity: —
 Category: F2

ITF8201

\$ 889,50

3-way Olympic Bench

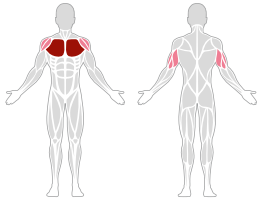

SPECIFICATIONS

Dimensions: 240,1x171,9x155,8 cm
 NET weight: 79,0 kg
 Max user weight: 150 kg
 Weight capacity: 200 kg
 Category: F2

ITF8101

\$ 587,90

Olympic Shoulder Bench

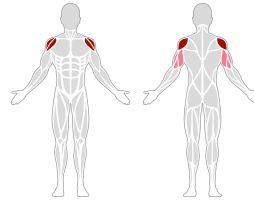

SPECIFICATIONS

Dimensions: 171,7x130,7x185,0 cm
 NET weight: 111,5 kg
 Max user weight: 150 kg
 Weight capacity: 300 kg
 Category: F2

ITF8701

\$ 352,00

Knee Raise

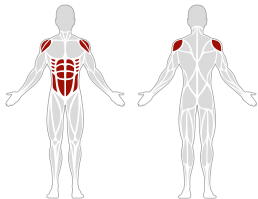

SPECIFICATIONS

Dimensions: 119,9x78,7x151,1 cm
 NET weight: 59,0 kg
 Max user weight: 150 kg
 Weight capacity: 150 kg
 Category: F2

ITF8702

\$ 578,00

Chin Up & Knee Raise

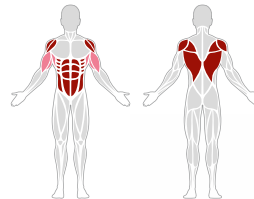

SPECIFICATIONS

Dimensions: 138,9x134,4x237,7 cm
 NET weight: 68,0 kg
 Max user weight: 150 kg
 Weight capacity: 150 kg
 Category: F2

ITF8301

Seal Row Bench

\$ 317,00

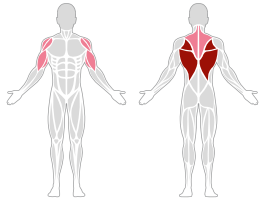

SPECIFICATIONS

Dimensions: 132,8x127,5x97,3 cm
 NET weight: 61,7 kg
 Max user weight: 150 kg
 Weight capacity: 200 kg
 Category: F2

ITF8501

Seated Arm Curl Bench

\$ 227,70

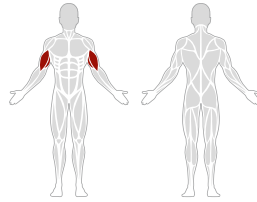

SPECIFICATIONS

Dimensions: 104,5x81,6x87,9 cm
 NET weight: 38,7 kg
 Max user weight: 150 kg
 Weight capacity: 100 kg
 Category: F2

ITF8404

Roman Bench

\$ 211,20

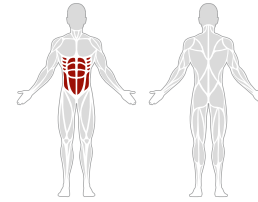

SPECIFICATIONS

Dimensions: 118,2x65,7x69,2 cm
 NET weight: 35,8 kg
 Max user weight: 150 kg
 Weight capacity: 200 kg
 Category: F2

ITF8401

Adjustable AB Bench

\$ 328,30

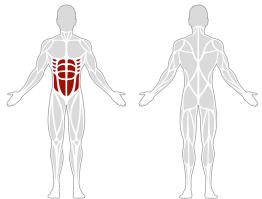

SPECIFICATIONS

Dimensions: 172,2x73,5x89,8 cm
 NET weight: 48,6 kg
 Max user weight: 150 kg
 Weight capacity: 150 kg
 Category: F2

ITF8802

Fi-Bench

\$ 296,40



SPECIFICATIONS

Dimensions: 143,6x69,9x43,0 cm
 NET weight: 43,5 kg
 Max user weight: 150 kg
 Weight capacity: 150 kg
 Category: F2

ITF8402

\$ 387,60

**Adjustable Back
Extension Bench**

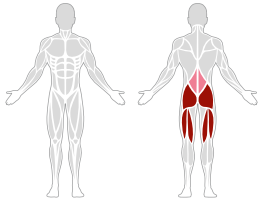

SPECIFICATIONS

Dimensions: 179,7x71,6x106,7 cm
 NET weight: 65,9 kg
 Max user weight: 150 kg
 Weight capacity: 175 kg
 Category: F2

ITF8618

\$ 258,30

**Sissy & Split
Squat Bench**

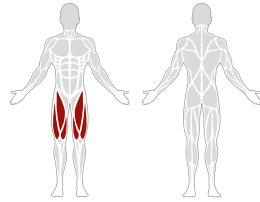

SPECIFICATIONS

Dimensions: 86,7x72,1x64,8 cm
 NET weight: 43,9 kg
 Max user weight: 150 kg
 Weight capacity: 100 kg
 Category: F2

ITF8613

\$ 480,50

Hip Thrust Bench

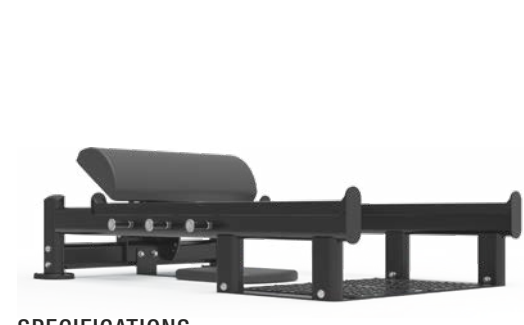
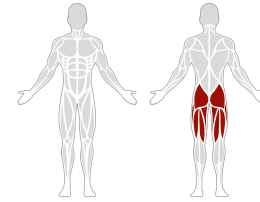

SPECIFICATIONS

Dimensions: 155,3x104,6x48,9 cm
 NET weight: 86,0 kg
 Max user weight: 150 kg
 Weight capacity: 250 kg
 Category: F2

ITF8801

\$ 149,80

Flat Bench



SPECIFICATIONS

Dimensions: 133,9x67,3x43,0 cm
 NET weight: 24,8 kg
 Max user weight: 150 kg
 Weight capacity: 150 kg
 Category: F2

ITF8406

\$ 625,90

Glute & Ham Bench

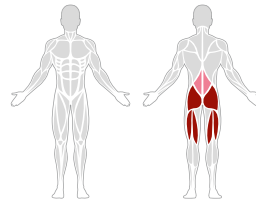

SPECIFICATIONS

Dimensions: 129,9x96,9x128,1 cm
 NET weight: 41,0 kg
 Max user weight: 150 kg
 Weight capacity: —
 Category: F2

ITF8601

\$ 613,90

Squat Rack

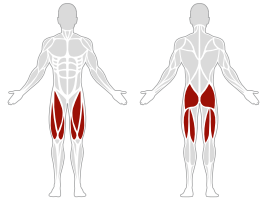

SPECIFICATIONS

Dimensions: 177,6x172,2x189,0 cm

NET weight: 124,0 kg

Max user weight: 150 kg

Weight capacity: 300 kg

Category: F2

ITF8102

\$ 185,90

Utility Bench



SPECIFICATIONS

Dimensions: 133,1x84,4x103,8 cm

NET weight: 26,4 kg

Max user weight: 150 kg

Weight capacity: 260 kg

Category: F2

ITF8805

\$ 472,20

Barbell Rack



SPECIFICATIONS

Dimensions: 88,7x74,4x142,6 cm

NET weight: 72,0 kg

Weight capacity: 680 kg

Category: F2

ITF8806

\$ 143,50

Plate Rack



SPECIFICATIONS

Dimensions: 96,1x71,6x121,2 cm

NET weight: 32,0 kg

Weight capacity: 600 kg

Category: F2

ITF8721

\$ 1.445,00

Vertical Smith



SPECIFICATIONS

Dimensions: 121,6x224,2x230,9 cm
 NET weight: 136,8 kg
 Max user weight: 150 kg
 Weight capacity: 250 kg
 Category: F2

ITF8722

\$ 1.445,00

7° Smith



SPECIFICATIONS

Dimensions: 122,6x224,1x230,9 cm
 NET weight: 136,5 kg
 Max user weight: 150 kg
 Weight capacity: 250 kg
 Category: F2

ITF8809

\$ 302,40

Dumbbell Rack
 For Hexagonal Dumbbells



SPECIFICATIONS

Dimensions: 198,0x85,6x92,8 cm
 NET weight: 71,0 kg
 Weight capacity: 750 kg
 Category: F2

ITF8810

\$ 458,80

Dumbbell Rack
 For Round Dumbbells

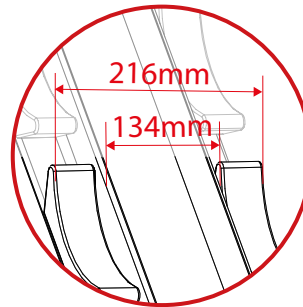

SPECIFICATIONS

Dimensions: 198,0x85,6x93,7 cm
 NET weight: 84,5 kg
 Weight capacity: 750 kg
 Category: F2





ENCORE

The Complete Series

Encore line is suitable for Hotel gyms, Physical therapy centers, Hospitals, Personal training studios & Rehabilitation centers



Learn more about the Encore line at www.amila.gr scan the QR-code



ES3000

\$ 3.185,00

» Can be combined with the Hi / Lo Pulley Attachment

ES3000OPT
(p. 393)

ES3000

3-station machine

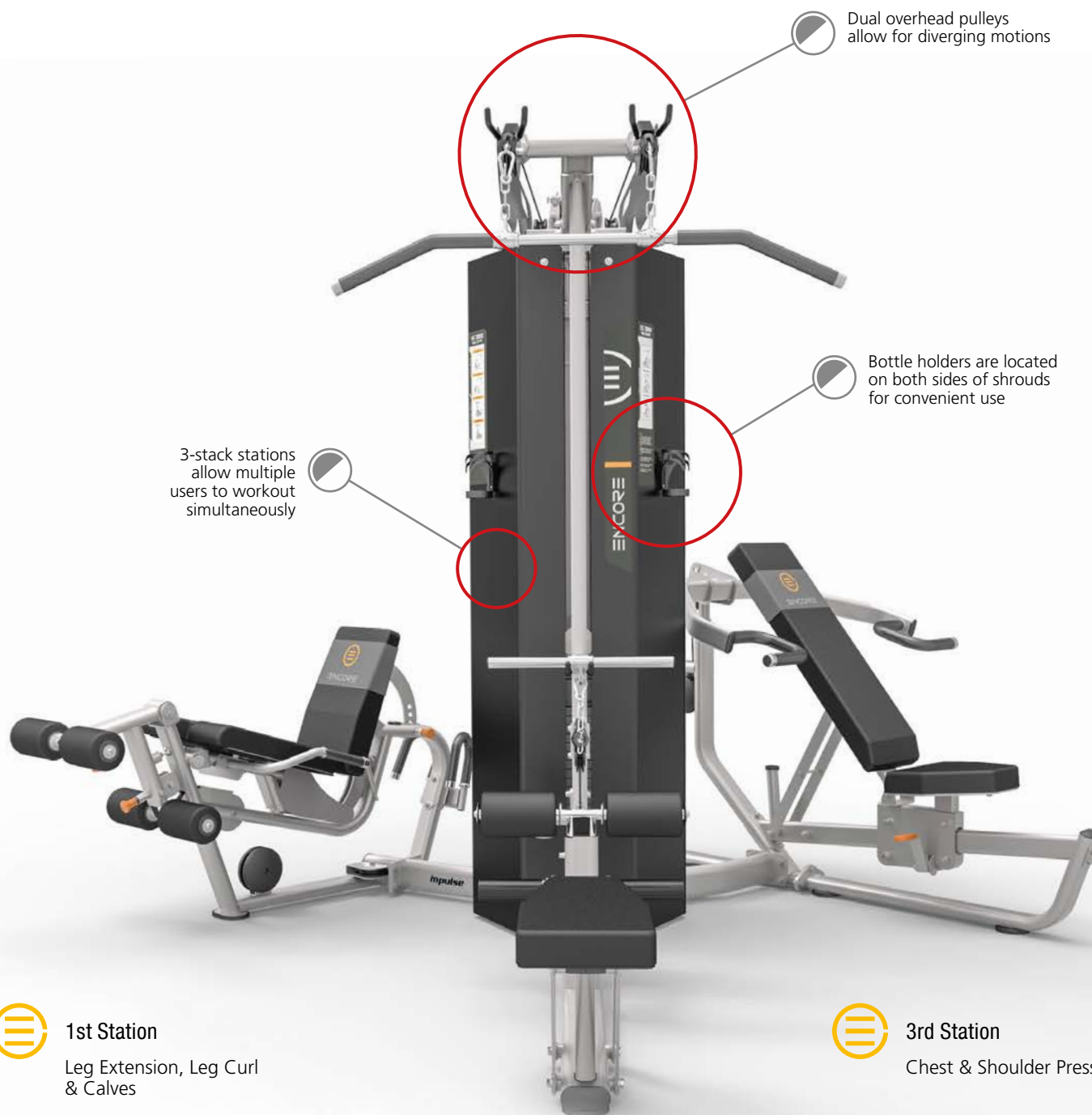

1st Station

Leg Extension, Leg Curl & Calves



3rd Station

Chest & Shoulder Press



2nd Station

Lat Pulldown & Vertical Row

SPECIFICATIONS

Dimensions: 364,2x292,9x217,7 cm

NET weight: 300 kg

Weight stacks: 3x91 kg

Category: F2

ES2100

Multi-Functional Trainer with Smith

ES2100

\$ 1.834,00

» Accessories included:

- Handles (2 pcs)
- Triceps rope
- Dip arms
- Rowing foot pedal
- Short bar
- Barbell storage
- Ankle strap
- Support strap

» Can be combined with:

- ES2000OPT1**
(p. 393) and
- ES2000OPT2**
(p. 393)

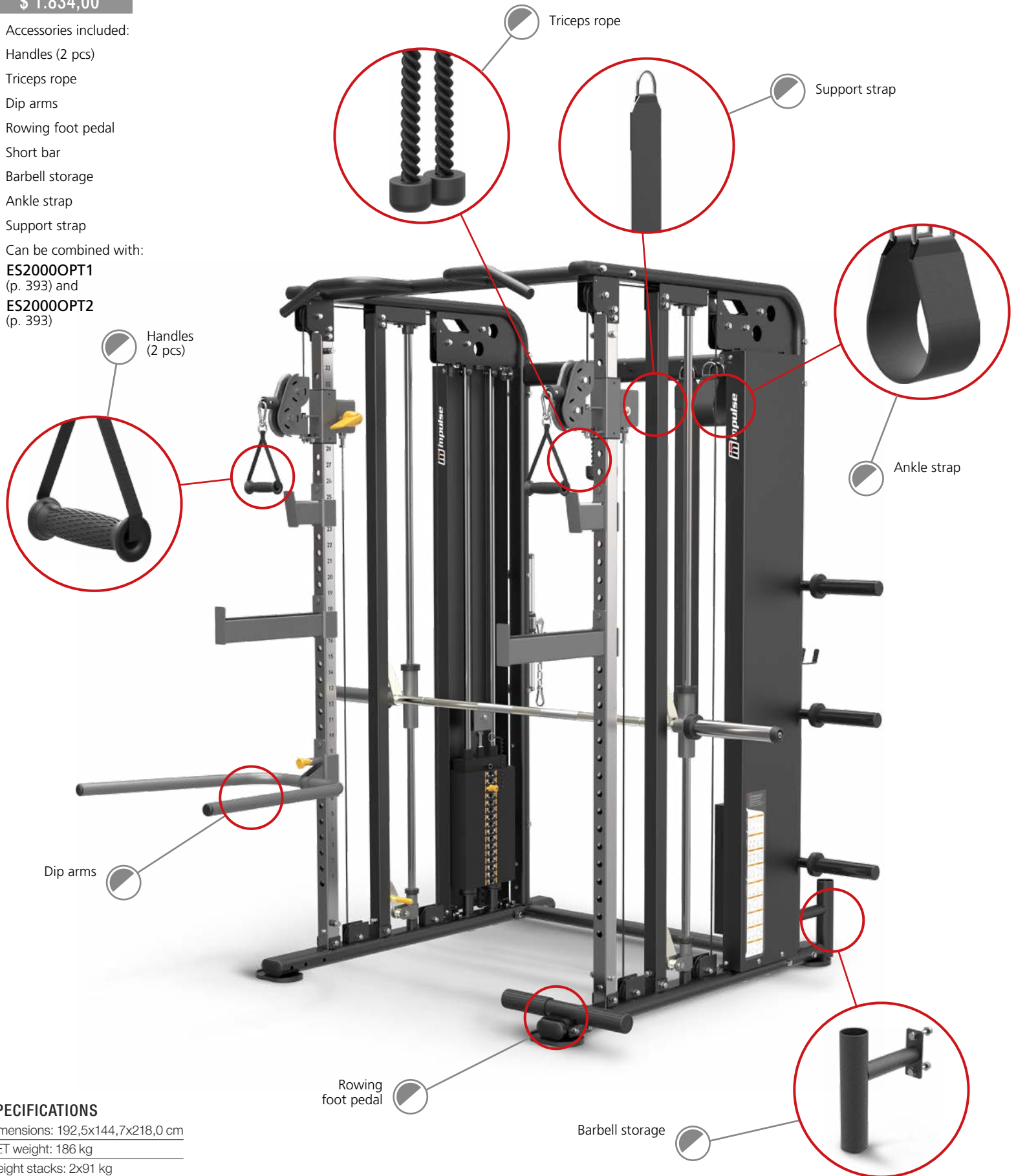

SPECIFICATIONS

Dimensions: 192,5x144,7x218,0 cm
 NET weight: 186 kg
 Weight stacks: 2x91 kg
 Category: F2

ES9030

\$ 1.520,00

» Accessories included

- Handles (2 pcs)
- Triceps rope
- Leg ext/curl strap
- Lat strap
- Long bar retractable strap

» Can be combined with bench

ES7011
(p. 393)

ES9030

Dual Pulley with Optional Bench

31 vertical pulley positions for a large variety of different exercises

Chin-up/pull-up bar with ergonomic bends for regular grip, wide grip and reverse grip exercises.

Tablet stand



SPECIFICATIONS

Dimensions: 173,4x112,3x215,0 cm

NET weight: 150 kg

Weight stacks: 2x77 kg

Category: F2

Hi / Lo Pulley Attachment

ES3000OPT

\$ 321,00

- » Accessory for ES3000 (p. 390)
- » Quick installation, shares the stack with lat pull for saving space and cost
- » 31 vertical pulley positions for a large variety of different exercises



SPECIFICATIONS

Dimensions: 37,6x81,9x214,5 cm
 NET weight: 26,5 kg
 Category: F2

Bench

ES7011

\$ 273,40

- » Can be combined with ES9030 (p. 392)



SPECIFICATIONS

Dimensions: 52,5x144,0x49,0 cm
 NET weight: 34,5 kg
 Category: F2

ES2000OPT1

\$ 21,90

- » Accessory for ES2100 (p. 391)

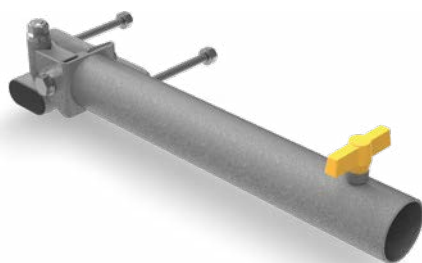

SPECIFICATIONS

Dimensions: 50,0x15,0x18,0 cm
 NET weight: 6,2 kg
 Category: F2

Pivot

ES2000OPT2

\$ 56,00

- » Accessory for ES2100 (p. 391)

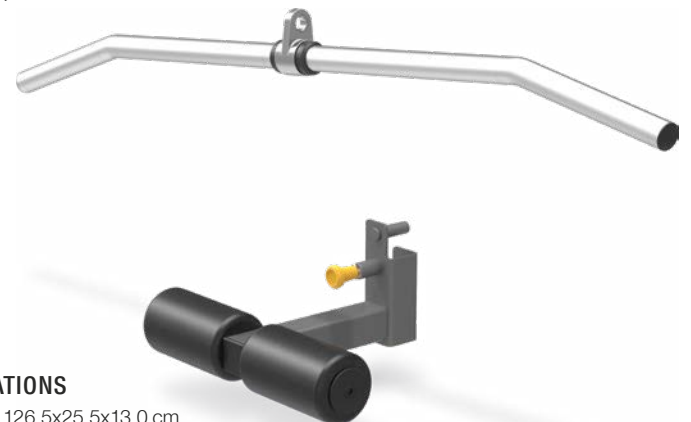

SPECIFICATIONS

Dimensions: 126,5x25,5x13,0 cm
 NET weight: 4,5 kg
 Category: F2

Pull Down Bar + Roller

ECU7

ECU7

\$ 915,00



SPECIFICATIONS

Dimensions: 62,8x113,2x147,2 cm
 NET weight: 67 kg
 Disk: 8 kg
 Resistance: 20 levels
 MAX user weight: 150 kg
 Category: F2

ECR7

ECR7

\$ 1.092,00



SPECIFICATIONS

Dimensions: 64,2x167,1x131,9 cm
 NET weight: 83 kg
 Disk: 8 kg
 Resistance: 20 levels
 MAX user weight: 150 kg
 Category: F2

ECE5

\$ 1.370,00



ECE5

SPECIFICATIONS

Dimensions: 81,2x184,9x178,0 cm
 NET weight: 120 kg
 Disk: 8 kg
 Resistance: 20 levels
 MAX user weight: 150 kg
 Category: F2

ECT7

\$ 1.855,00

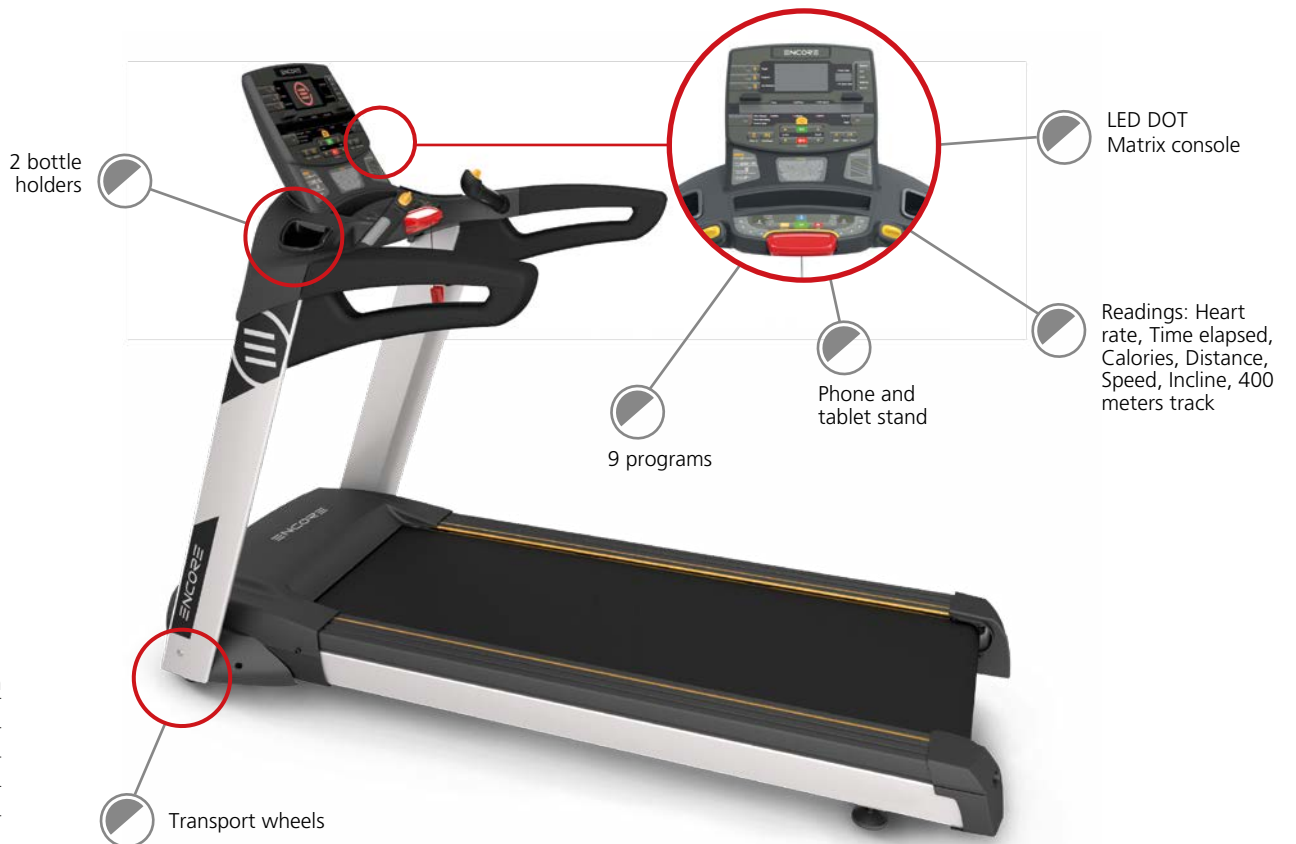
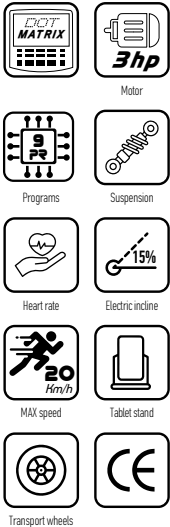

ECT7

SPECIFICATIONS

Dimensions: 94,0x205,1x145,9 cm
 NET weight: 150 kg
 Motor: 3hp
 MAX speed: 20 Km/h
 Incline: Electronic 15%
 Running surface: 51,0x152,5 cm
 MAX user weight: 160 kg
 Category: F2

in impulse PL Line

The clear and precise instructions and training tips are great for individuals who are new to strength training and help users to build targeted muscles



Translucent cover for safety

Electro-welded 2,5-2,7mm tubes for maximum durability

Aircraft specs 5mm cables, from LOOS (USA), rated at over 900kg tensile strength, tested for more than 250.000 repetitions using the full stack

PL line consists of high quality machines, utilizing two or more functions, intended for high commercial use, with attractive design.

The user friendly design simplifies exercising and makes it more efficient and comfortable.



Nylon pulleys, reinforced with glass fibers and deep notches, offer safe and smooth movement of the cable

Ergonomically designed grips with aluminum caps for a more refined look

Ergonomic 70mm thick pads

Stainless steel seat adjustment that provides a longer service life, easy to adjust and looks beautiful



Learn more about the PL line at www.amila.gr scan the QR-code

The weight stack is not included in the price

Muscle groups:
● Main ● Secondary

PL9022

\$ 865,00

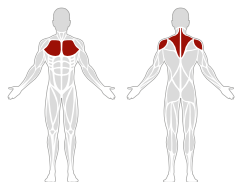

Rear Deltoid / Pectoral Fly



PL9022B

\$ 865,00



SPECIFICATIONS

Dimensions: 129,9x136,5x206,1 cm

NET weight: 107 kg

Category: F2

PL9021

\$ 863,00

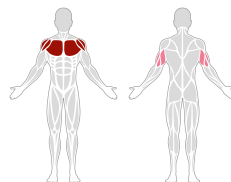

Multi Press



PL9021B

\$ 863,00

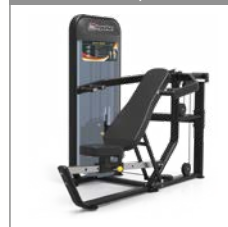

SPECIFICATIONS

Dimensions: 132,4x193,2x152,0 cm

NET weight: 112 kg

Category: F2

PL9002

\$ 760,00

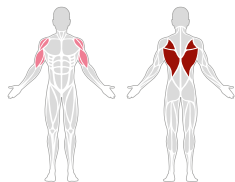

Lat Pulldown / Seated Row



PL9002B

\$ 760,00

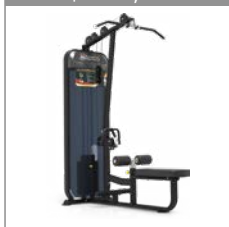

SPECIFICATIONS

Dimensions: 102,0x176,5x218,2 cm

NET weight: 90,5 kg

Category: F2

PL9010

\$ 915,00

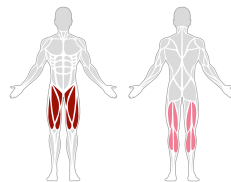

Leg Press / Calf Raise



PL9010B

\$ 915,00

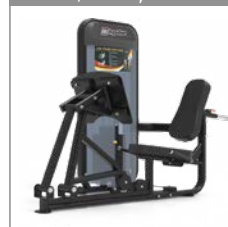

SPECIFICATIONS

Dimensions: 114,7x216,5x152,0 cm

NET weight: 111 kg

Category: F2

PL9016

\$ 821,00

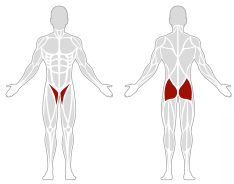

Inner / Outer Thigh



PL9016B

\$ 821,00



SPECIFICATIONS

Dimensions: 173,9x160,9x152,0 cm
NET weight: 99 kg
Category: F2

PL9019

\$ 943,00

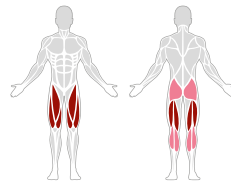

Leg Extension / Leg Curl



PL9019B

\$ 943,00

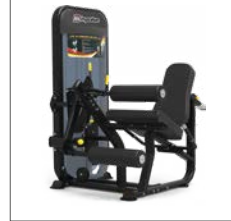

SPECIFICATIONS

Dimensions: 124,5x146,5x152,0 cm
NET weight: 116 kg
Category: F2

PL9024

\$ 776,00

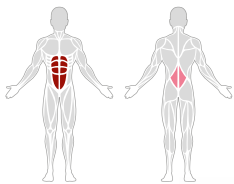

Ab / Low Back



PL9024B

\$ 776,00



SPECIFICATIONS

Dimensions: 109,9x104,4x152,0 cm
NET weight: 107 kg
Category: F2

PL9023

\$ 540,00

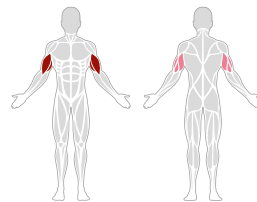

Biceps / Triceps



PL9023B

\$ 540,00



SPECIFICATIONS

Dimensions: 116,4x120,7x151,3 cm
NET weight: 106 kg
Category: F2

Weight Stack

PLWS170

\$ 235,50

» Weight: 77Kg/170Lbs

PLWS250

\$ 348,00

» Weight: 113Kg/250Lbs



in *impulse*

IFP Line



IFP line consists of machines for various muscle groups, such as chest, shoulders, back, legs and arms. It is strictly designed according to parameters as human mechanics and muscle strength lines. The included machines can perform different functions and exercise different muscle groups.

Without decreasing the functionality of the machines, IFP line requires less space due to their structural design, so that more machines can fit in a given space.

Disk placement
to change the
resistance

Safety
limiters

Auxiliary
handles

Plate storage

Ergonomic
pads



Learn more about the IFP line at
www.amila.gr scan the QR-code

Muscle groups:
● Main ● Secondary

IFP 1101

\$ 421,50

Seated Shoulder Press

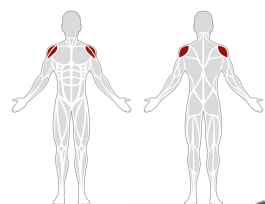

SPECIFICATIONS

Dimensions: 157,9x152,0x106,9 cm
 NET weight: 87,0 kg
 Weight capacity: 300 kg
 Category: F2

IFP 1201

\$ 365,00

Seated Chest Press

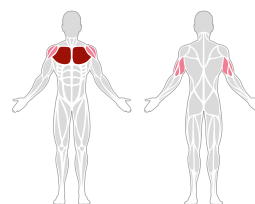

SPECIFICATIONS

Dimensions: 127,6x98,4x124,8 cm
 NET weight: 64,2 kg
 Weight capacity: 200 kg
 Category: F2

IFP 1206

\$ 376,20

Standing Chest Fly

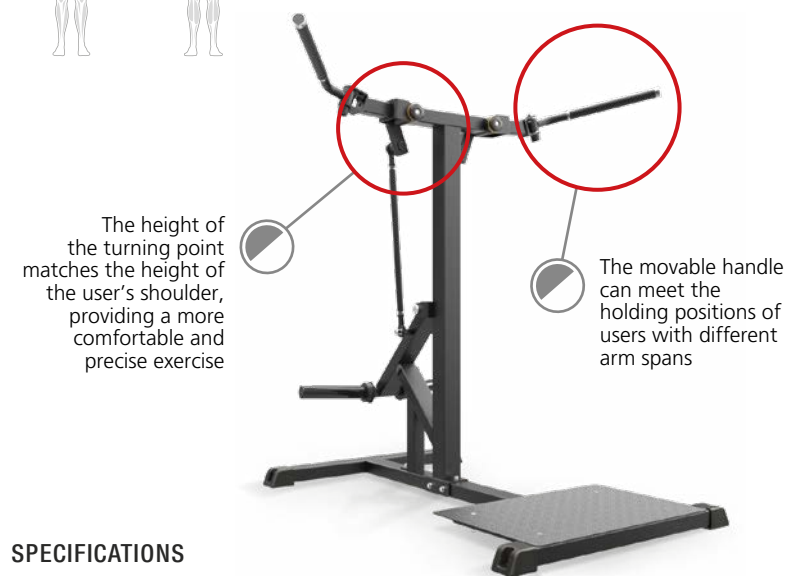
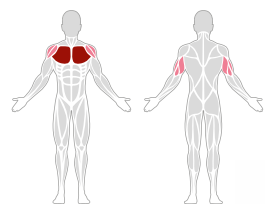

SPECIFICATIONS

Dimensions: 131,0x151,5x149,1 cm
 NET weight: 70 kg
 Weight capacity: 200 kg
 Category: F2

IFP 1103

\$ 316,50

Standing Lateral Raise

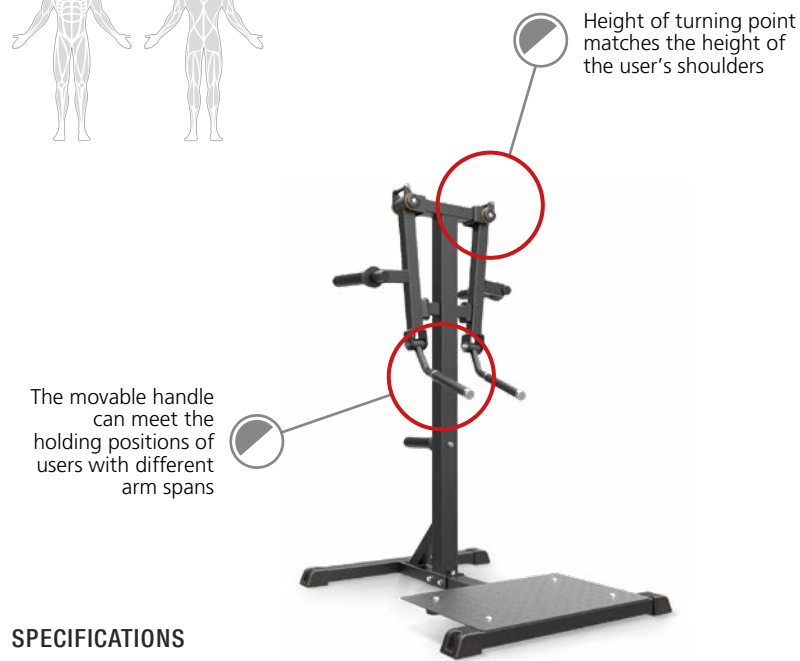
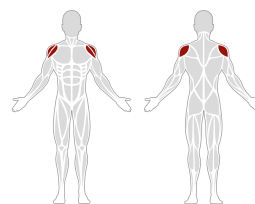

SPECIFICATIONS

Dimensions: 116,5x88,5x155,0 cm
 NET weight: 57,3 kg
 Weight capacity: 200 kg
 Category: F2

IFP1706

\$ 301,00

Biceps / Triceps

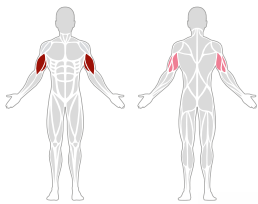

SPECIFICATIONS

Dimensions: 70,8x109,2x128,7 cm
 NET weight: 47,3 kg
 Weight capacity: 200 kg
 Category: F2

IFP1501

\$ 366,90

Bicep Curl

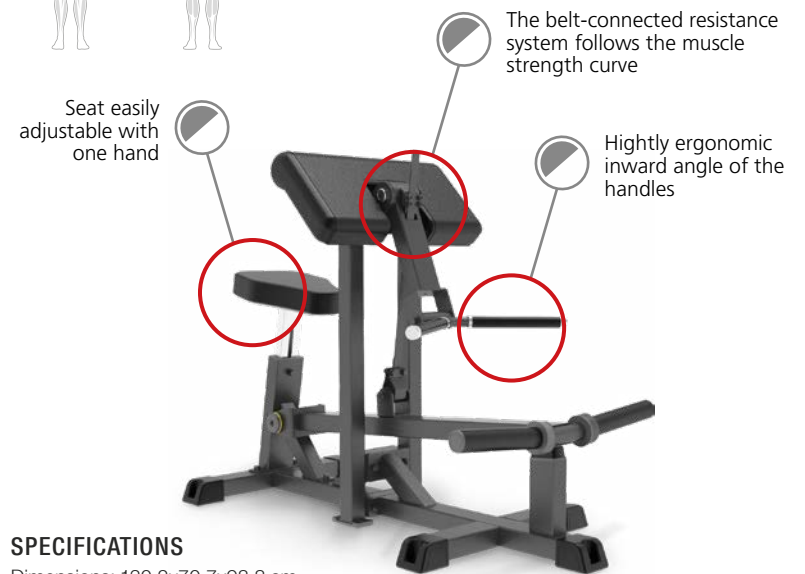
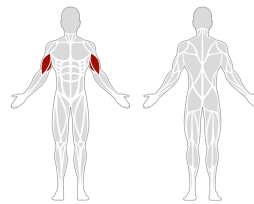

SPECIFICATIONS

Dimensions: 130,2x70,7x98,8 cm
 NET weight: 56,0 kg
 Weight capacity: 200 kg
 Category: F2

IFP1301

\$ 477,80

Lat Pulldown

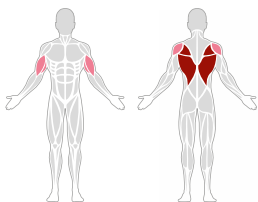

SPECIFICATIONS

Dimensions: 170,3x133,9x204,7 cm
 NET weight: 95,0 kg
 Weight capacity: 200 kg
 Category: F2

IFP1302

\$ 415,00

Seated Row

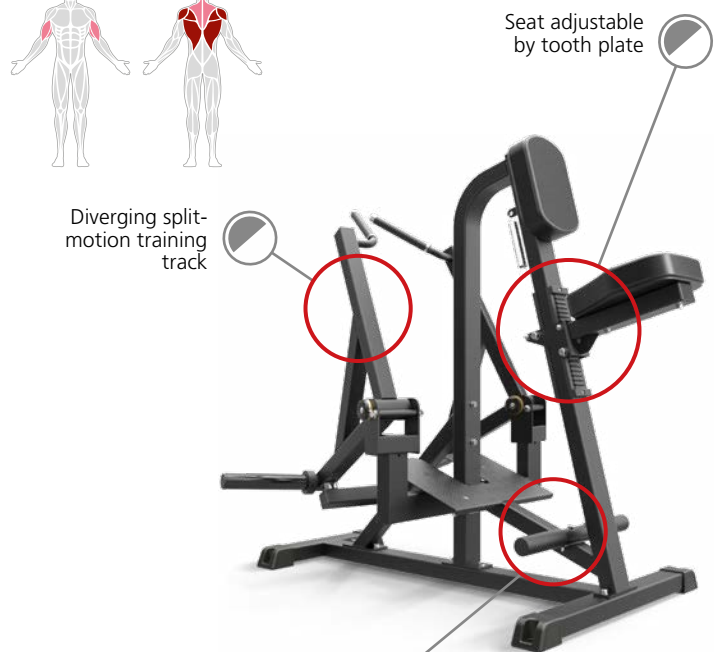
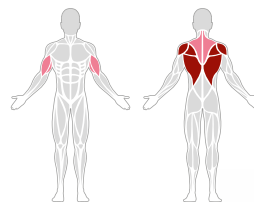

SPECIFICATIONS

Dimensions: 102,0x147,0x134,0 cm
 NET weight: 77,5 kg
 Weight capacity: 200 kg
 Category: F2

IFP1305

\$ 279,50

T-Bar Row

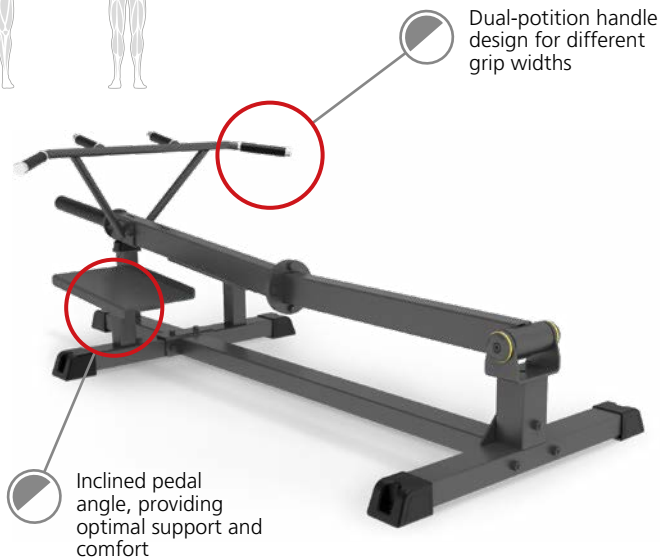
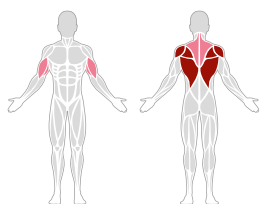

SPECIFICATIONS

Dimensions: 207,9x90,8x63,5 cm
 NET weight: 23,0 kg
 Weight capacity: 150 kg
 Category: F2

IFP1721

\$ 725,00

Half Cage / Smith Machine

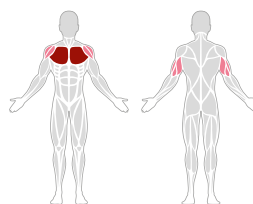

SPECIFICATIONS

Dimensions: 185,0x140,4x234,3 cm
 NET weight: 77,5 kg
 Weight capacity: 250 kg
 Category: F2

IFP1721OPT

\$ 340,00

**Lat Pulldown
Seated Row Attachment**

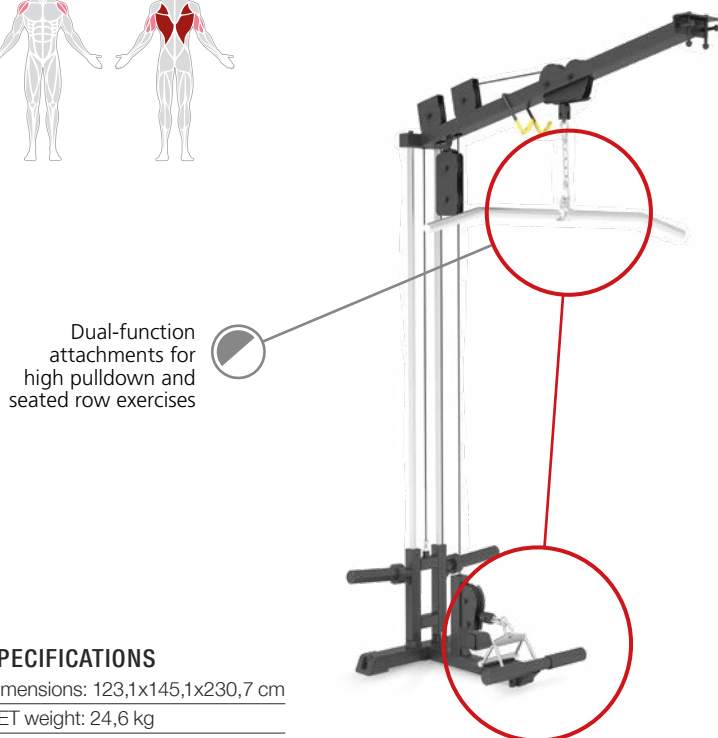
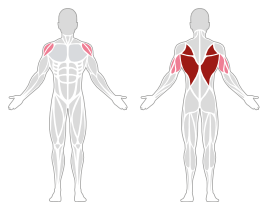

SPECIFICATIONS

Dimensions: 123,1x145,1x230,7 cm
 NET weight: 24,6 kg
 Weight capacity: 200 kg
 Category: F2

IFP1616

\$ 382,00

Vertical Hip Thrust

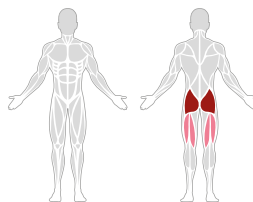

SPECIFICATIONS

Dimensions: 122,0x109,8x116,5 cm
 NET weight: 67,5 kg
 Weight capacity: 150 kg
 Category: F2

IFP1614

\$ 555,00

Hip Thrust

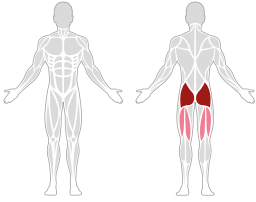

Wide and sturdy resistance belt with foam padding for safety and comfort



Quick-lock resistance belt to easily start/end the training session

Spacious anti-slip foot platform, accommodates the training needs of all body types

Seat cushion facilitating easy mounting/dismounting

SPECIFICATIONS

Dimensions: 129,2x144,9x78,4 cm
NET weight: 90,0 kg
Weight capacity: 100 kg
Category: F2

IFP1619

\$ 345,00

Reverse Hyperextension

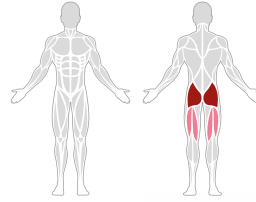

Auxiliary pedals to get on and off the machine and a soft strap for increased comfort



Ergonomic pads

SPECIFICATIONS

Dimensions: 79,7x131,0x115,3 cm
NET weight: 66,0 kg
Weight capacity: 100 kg
Category: F2

IFP1622

\$ 439,00

Standing Hip Abductor

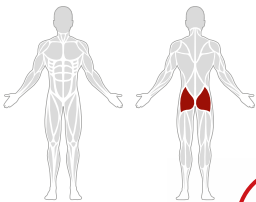

Fixed armrests to maintain body balance



Extended leg pads to meet the needs of users of different heights

Foot pedals with anti-slip texture and cuffed edges

SPECIFICATIONS

Dimensions: 59,5x172,0x128,0 cm
NET weight: 83,9 kg
Weight capacity: 150 kg
Category: F2

IFP1607

\$ 609,00

Standing Adduction

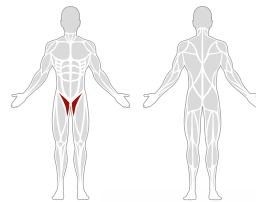

Resistance release handle, enabling easy resistance disengagement after the workout, facilitating safe and convenient dismount

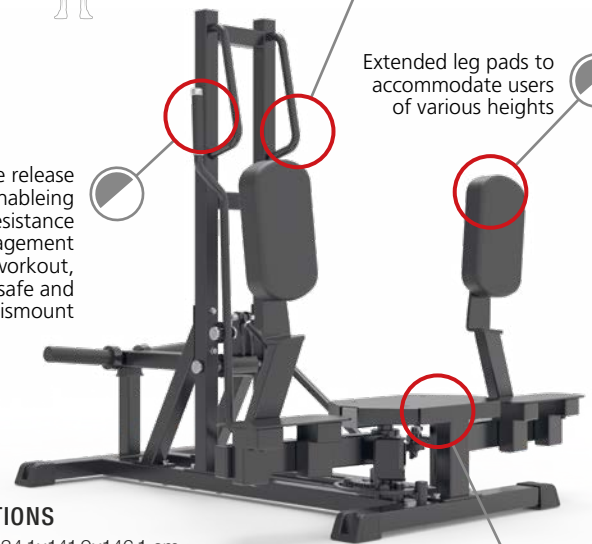

Long, curved fixed handrail design, accommodates the training needs of users with varying heights and arm spans

Extended leg pads to accommodate users of various heights

SPECIFICATIONS

Dimensions: 134,1x141,9x146,1 cm
NET weight: ***** kg
Weight capacity: ***** kg
Category: F2

Equipped with an entry step for convenient mounting and dismounting

IFP1604

\$ 375,40

Prone Leg Curl

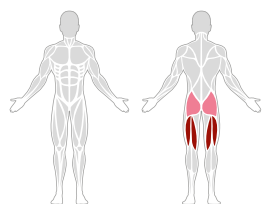

SPECIFICATIONS

Dimensions: 120,2x162,3x79,8 cm
 NET weight: 75,5 kg
 Weight capacity: 150 kg
 Category: F2

IFP1605

\$ 349,00

Seated Leg Extension

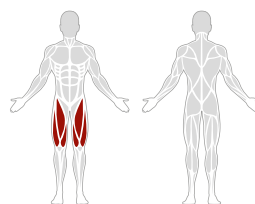

SPECIFICATIONS

Dimensions: 117,3x124,6x99,5 cm
 NET weight: 63,4 kg
 Weight capacity: 150 kg
 Category: F2

IFP1623

\$ 205,50

Seated Calf Raise

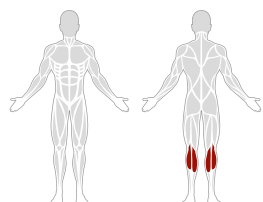

SPECIFICATIONS

Dimensions: 56,6x136,8x84,9 cm
 NET weight: 38,5 kg
 Weight capacity: 100 kg
 Category: F2

IFP1707

\$ 571,00

Leverage Squat / Calf

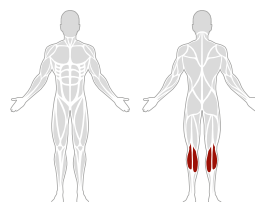

SPECIFICATIONS

Dimensions: 144,5x149,0x155,0 cm
 NET weight: 115,5 kg
 Weight capacity: 350 kg
 Category: F2

IFP1615

\$ 395,80

Belt Squat

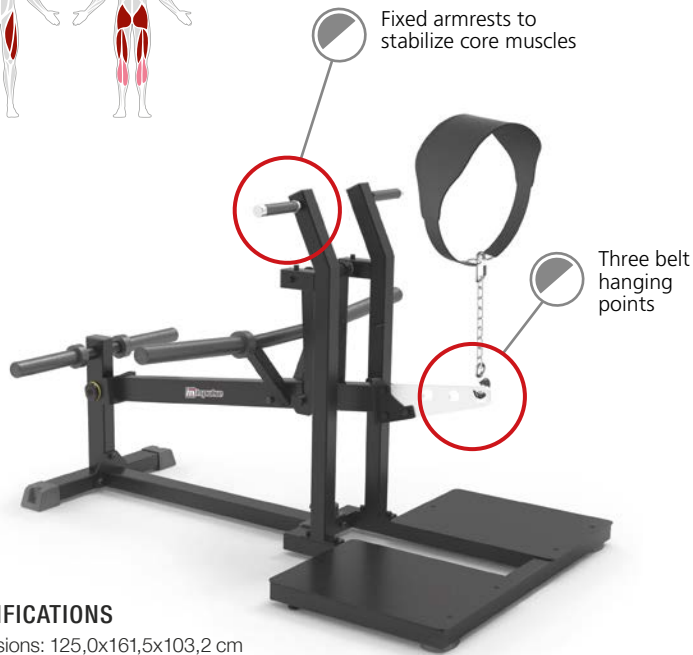
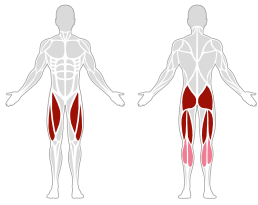

SPECIFICATIONS

Dimensions: 125,0x161,5x103,2 cm
 NET weight: 77,5 kg
 Weight capacity: 350 kg
 Category: F2

IFP1613

\$ 558,00

Vertical Leg Press

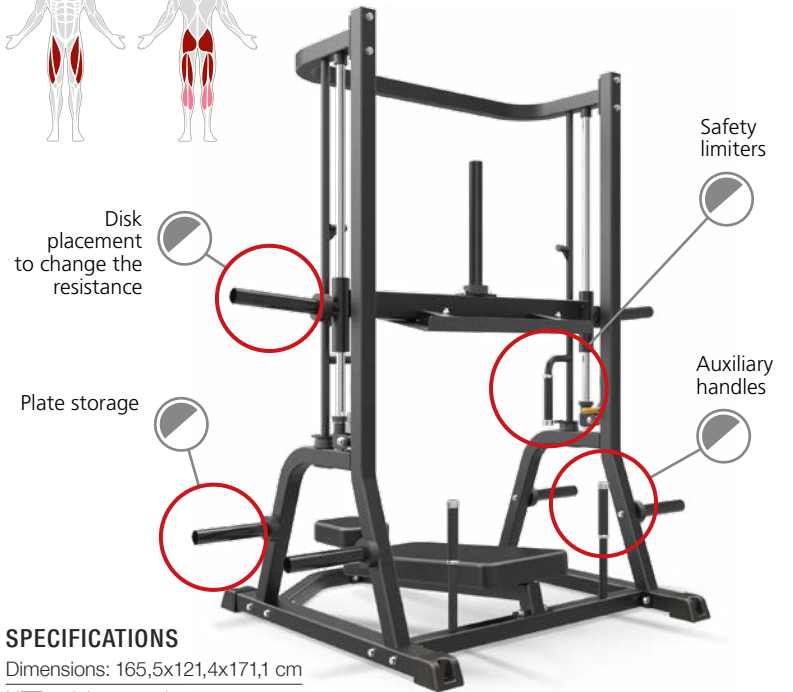
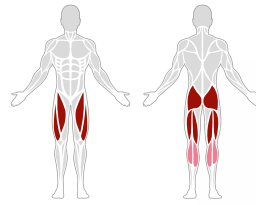

SPECIFICATIONS

Dimensions: 165,5x121,4x171,1 cm
 NET weight: 110,4 kg
 Weight capacity: 350 kg
 Category: F2

IFP1617

\$ 762,00

Hack Squat

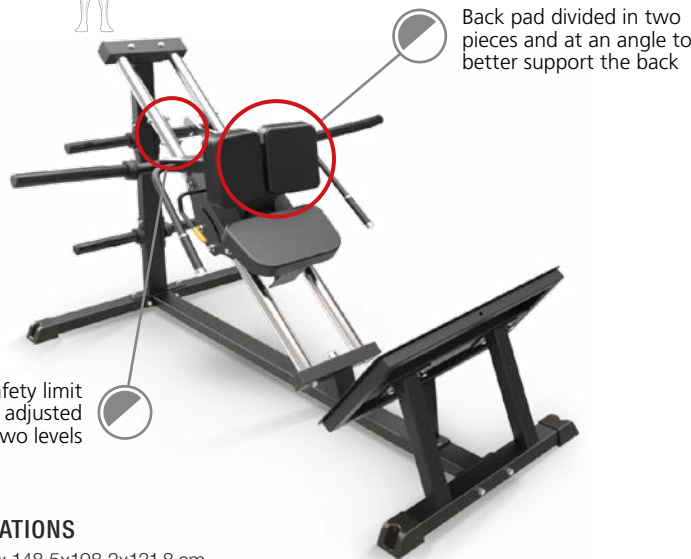
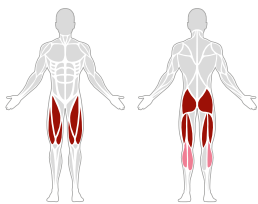

SPECIFICATIONS

Dimensions: 148,5x198,2x131,8 cm
 NET weight: 100,6 kg
 Weight capacity: 350 kg
 Category: F2

IFP1711

\$ 736,00

Hack Squat / Leg Press

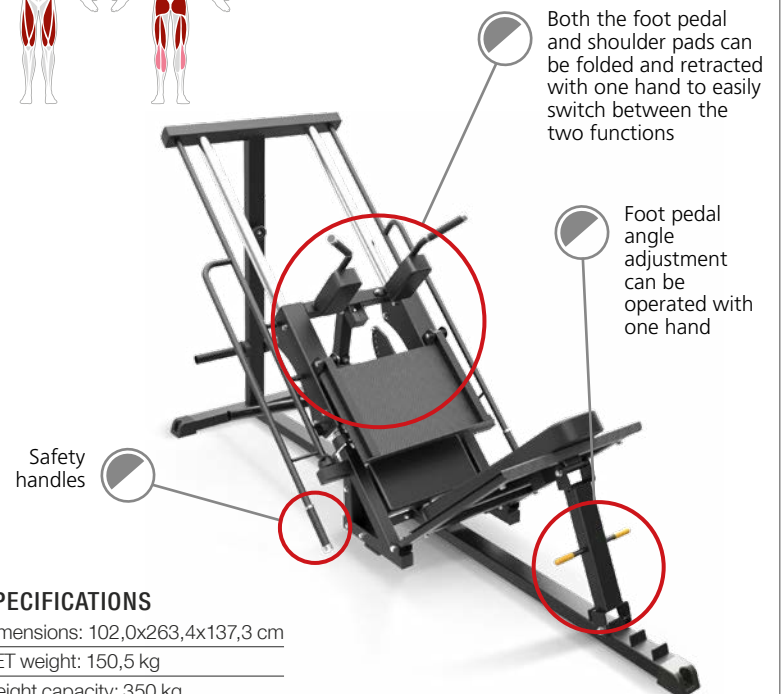
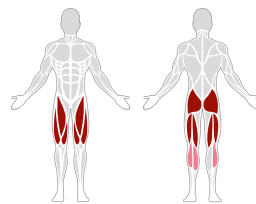

SPECIFICATIONS

Dimensions: 102,0x263,4x137,3 cm
 NET weight: 150,5 kg
 Weight capacity: 350 kg
 Category: F2



CODE



PRICE



NAME











DIMENSIONS (cm)









PAGE

















IZ Line (I-Zone)

	IZ7001	\$ 870,00	Stretching	165,5 × 168,3 × 236,4	295
	IZ7002	\$ 902,00	Box	165,5 × 112,6 × 239,0	295
	IZ7003	\$ 998,00	Rebound	165,5 × 107,2 × 234,0	295
	IZ7004	\$ 923,00	Half Rack	174,7 × 140,9 × 244,3	295
	IZ7005	\$ 2.425,00	Dap	182,6 × 75,6 × 236,5	296
	IZ7006	\$ 86,00	Connector	152,8 × 17,8 × 20,5	296
	IZ7007	\$ 345,00	Stair 2	285,0 × 111,7 × 20,4	297
	IZ7008	\$ 389,00	Stair 1	351,0 × 101,0 × 20,5	297
	IZ7009	\$ 277,30	Step Attachment	75,0 × 65,0 × 28,9	297
	IZ7010	\$ 186,90	Dip Attachment	94,0 × 62,4 × 28,9	297
	IZ7011	\$ 18,40	"S" Joint	17,8 × 10,0 × 5,0	296













					
CODE	PRICE	NAME	DIMENSIONS (cm)	PAGE	
	IZ7012	\$ 43,60	Pivot	53,1 × 12,6 × 17,8	297
	IZ7014	\$ 374,00	Stair	243,5 × 120,7 × 20,5 .	297
	IZ7015	\$ 258,00	Stair	240,6 × 170,4 × 20,5 .	297
	IZ7017	\$ 136,00	Battle Rope Reel	65,0 × 65,0 .	297

MS Line (Mega Space)





	MS00	\$ 374,00	Stand - Single Storage	179,0 × 60,9 × 261,4 .	301
	MS01	\$ 736,00	Half Rack	137,7 × 126,1 × 261,4 .	301
	MS02	\$ 1.120,00	Power Rack	137,7 × 230,6 × 261,4 .	301
	MS11	\$ 788,90	LAT Pulldown / Vertical Row	122,6 × 216,0 × 259,6 .	300
	MS12	\$ 503,50	Functional Cable Pulley	49,6 × 131,3 × 259,9 .	300
	MS13	\$ 426,00	Jammer Arms	87,5 × 36,9 × 139,5 .	302
	MS14	\$ 188,20	Belt Squat	111,2 × 55,0 × 67,7 .	305

















 CODE	 PRICE	 NAME	 DIMENSIONS (cm)	 PAGE
	MS15	\$ 480,00	Endless Rope Trainer	26,6 × 52,7 × 53,7 . 302
	MS21	\$ 94,00	Rack Connected Bridge	205,6 × 24,0 × 19,2 . 303
	MS22	\$ 120,50	Rack Connected Bridge	275,6 × 24,0 × 19,2 . 303
	MS23	\$ 162,00	Bumper Plate Storage Connector Between Rack	212,0 × 38,5 × 28,6 . 304
	MS24	\$ 220,50	Kettlebell Storage Connector Between Rack	212,0 × 44,1 × 10,7 . 304
	MS25	\$ 98,60	Ball Storage Connector Between Rack	212,0 × 38,5 × 10,8 . 304
	MS26	\$ 157,80	Dumbbell Storage Connector Between Rack	212,0 × 38,5 × 227,0 . 304
	MS27	\$ 199,00	Side Storage	99,5 × 41,6 × 76,3 . 305
	MS28	\$ 140,00	Multi Station Connected Bridge	14,5 × 300,0 × 7,6 . 303
	MS29	\$ 89,00	Central Connected Stand	261,4 × 16,0 × 16,0 . 303
	MS31		Platform	244,6 × 342,1 × 5,0 . 302
	MS32		Platform	257,6 × 382,5 × 5,4 . 302

 CODE	 PRICE	 NAME	 DIMENSIONS (cm)	 PAGE
	MS41	\$ 130,00	Side Storage	134,0 × 40,0 × 7,7 . 304
	MS43	\$ 52,00	Adjustable Utility Pins	59,0 . 307
	MS44	\$ 36,00	Barbell-Utility Platform Storage Attachment	28,0 × 24,0 × 18,0 . 304
	MS45	\$ 73,00	Foam Roller Pads	55,9 . 307
	MS7041	\$ 74,00	Barbell Lifter	78,1 × 61,8 × 90,5 . 306
	MS7042	\$ 78,50	Farmer's Walk Bar	144,0 × 16,9 × 7,6 . 306
	MS7043	\$ 31,60	T-Bar Row Handle	90,8 × 25,7 × 20,5 . 306
	MS7048	\$ 209,20	Power Sled	104,0 × 70,2 × 92,2 . 306
	HSPCF28	\$ 80,00	Multi Angle Pull Up Handle	114,3 × 32,4 × 10,9 . 306
	HSPCF29	\$ 180,00	Triphasic Training Arms	72,1 × 108,1 × 10,5 . 303
	HSPCF42	\$ 90,90	Tricep Dip Attachment	64,9 × 77,9 × 25,0 306
	HSPCF47	\$ 60,90	Resistant Band Anchor	30,5 . 307

				
CODE	PRICE	NAME	DIMENSIONS (cm)	PAGE
	HSPCF49	\$ 180,00	Safety Straps	115,0 × 5,0 × 1,0 . 305
	HSPCF51	\$ 22,30	Battle Rope Anchor	7,0 × 15,2 × 18,0 . 307
	HSPCF52	BCHS07500HS	Landmine Rack Attachment	12,6 × 53,0 × 24,0 . 305
	HSPCF54	\$ 47,20	J Hook Attachment	22,4 × 29,6 × 22,4 . 307
	HSPCF59	\$ 105,90	Ball Grip Attachment	20,7 × 20,9 × 7,6 . 307
	IZCFA12	\$ 103,00	Wall Ball Target	55,0 × 24,6 × 60,8 . 305
	IZCFA16	\$ 86,80	Heavy Bag Hanger	96,3 × 76,2 × 6,0 . 303

SE Series (Sterling Elite)

	SE5001	\$ 692,00	Half Rack	133,8 × 130,1 × 247,6 . 311
	SE5002	\$ 945,50	Power Rack	133,8 × 196,8 × 247,6 . 311
	SE5011	\$ 269,00	Stand-Single Storage	184,2 × 56,3 × 246,6 . 311
	SE5012	\$ 305,00	Combo Storage-Single	184,2 × 103,1 × 246,6 . 311

 CODE	 PRICE	 NAME	 DIMENSIONS (cm)	 PAGE
 SE5021	\$ 128,00	Rack Connector / Multi-Grip	190,0 × 22,5 × 23,0 .	312
 SE5022	\$ 43,00	Rack Connector-Thick Straight	190,0 × 7,6 × 23,0 .	312
 SE5023	\$ 116,00	Bumper Plate Storage Connector	190,0 × 7,6 × 23,0 .	312
 SE5024	\$ 192,00	Free Storage Connector	190,0 × 43,2 × 17,1 .	312
 SE5025	\$ 65,00	Ball Storage Connector	190,0 × 28,0 × 26,0 .	312
 SE5041	\$ 22,00	Band Pegs	32,5 × 10,1 × 5,0 .	313
 SE5042	\$ 87,00	Reverse J-Hooks	9,5 × 25,2 × 25,0 .	313
 SE5043	\$ 163,00	Spotter Stands	40,0 × 23,5 × 44,2 .	312
 HZ7009	\$ 204,00	Step Attachment	66,1 × 77,3 × 33,8 .	313
 HZ7010	\$ 109,00	Dip Attachment	62,5 × 94,6 × 33,9 .	313
 IZ7012	\$ 43,60	Landmine Rack Attachment	12,6 × 53,0 × 28,9 .	313



CODE







PRICE

NAME



DIMENSIONS (cm)

PAGE

















HZ Line (H-Zone)

















	HZ7001	\$ 960,00	Power Rack Station	173,7 × 172,3 × 255,8 .	319
	HZ7002	\$ 540,00	Hi-Low Pulley Station	110,6 × 110,9 × 241,3 .	319
	HZ7004	\$ 132,00	Multi-Function Connector	228,4 × 45,3 × 20,3 .	319
	HZ7006	\$ 28,00	Wall Connector	86,6 × 20,0 × 7,5 .	319
	HZ7009	\$ 204,00	Step Attachment	66,1 × 77,3 × 33,8 .	318
	HZ7010	\$ 109,00	Dip Attachment	62,5 × 94,6 × 33,9 .	318
	IZ7012	\$ 43,60	Pivot	12,6 × 53,0 × 28,9 .	318















SL Line

	SL7001	\$ 1.130,00	Chest Press	198,0 × 137,5 × 171,8	326
	SL7002	\$ 1.132,00	Pulldown	140,8 × 165,9 × 197,3	327
	SL7003	\$ 1.120,00	Shoulder Press	175,4 × 154,5 × 148,2	327

	 CODE	 PRICE	 NAME	 DIMENSIONS (cm)	 PAGE
	SL7004	\$ 1.168,00	Low Row	152,6 × 176,1 × 165,2	328
	SL7005	\$ 1.195,00	Incline Chest Press	207,2 × 152,3 × 176,5	326
	SL7006	\$ 1.238,00	Leg Press	142,1 × 226,6 × 141,5	329
	SL7007	\$ 1.094,00	Row	145,0 × 181,5 × 133,4	327
	SL7008	\$ 940,00	Rear Kick	129,9 × 1680 × 163,8	331
	SL7009	\$ 1.195,00	Power Rack	149,9 × 203,1 × 227,8	322
	SL7009OPT	\$ 364,00	Weight Platre Rack Option	167,3 × 71,7 × 219,9	322
	SL7010	\$ 295,00	Plate Rack	62,8 × 90,3 × 123,9	325
	SL7011	\$ 295,00	FID Bench	63,9 × 150,2 × 114,8	324
	SL7012	\$ 355,00	FI Bench	63,9 × 154,4 × 99,2	324
	SL7013	\$ 548,00	Glute Ham Bench	89,9 × 155,9 × 148,2	332
	SL7014	\$ 815,00	Half Rack	174,6 × 139,9 × 244,2	323

 CODE	 PRICE	 NAME	 DIMENSIONS (cm)	 PAGE
	SL7015	\$ 1.065,00	Full Rack	174,6 × 196,6 × 244,2 323
	SL7016	\$ 474,50	Dumbbell Rack	225,8 × 75,9 × 73,8 325
	SL7017	\$ 395,00	Seated Calf Raise	75,7 × 147,5 × 84,4 332
	SL7018	\$ 456,50	Arm Curl	86,0 × 113,6 × 101,6 328
	SL7019	\$ 592,00	Incline Row	104,8 × 196,3 × 126,2 328
	SL7020	\$ 2.182,00	Reverse Leg Press	193,3 × 246,1 × 153,4 329
	SL7021	\$ 1.718,00	Hack Squat	188,0 × 220,6 × 128,6 329
	SL7022	\$ 177,00	Utility Bench	63,1 × 119,0 × 82,2 325
	SL7023	\$ 885,00	Bicep Curl	104,5 × 149,4 × 119,9 328
	SL7024	\$ 1.155,00	Tricep Dip	157,8 × 173,1 × 120,4 327
	SL7025	\$ 1.030,00	Leg Extension	169,0 × 134,5 × 103,7 329
	SL7026	\$ 1.058,00	Leg Curl	130,0 × 152,7 × 140,6 330







	 CODE	 PRICE	 NAME	 DIMENSIONS (cm)	 PAGE
	SL7027	\$ 510,00	Barbell Rack	95,0 × 91,0 × 161,2	325
	SL7028	\$ 647,00	Flat Bench	173,8 × 191,0 × 131,5	326
	SL7029	\$ 776,00	Incline Bench	171,8 × 205,9 × 149,6	333
	SL7030	\$ 695,00	Decline Bench	171,8 × 237,0 × 131,5	333
	SL7031	\$ 988,00	Shoulder Bench Press	171,9 × 126,1 × 192,0	334
	SL7032	\$ 1.005,00	Standing Calf Raise	160,5 × 148,5 × 181,3	332
	SL7034	\$ 1.385,00	Squat	155,5 × 230,2 × 126,6	331
	SL7035	\$ 191,00	Flat Bench	63,0 × 128,1 × 42,6	324
	SL7036	\$ 1.058,00	Abdominal	134,4 × 126,7 × 164,2	334
	SL7038	\$ 755,00	Total Hip	160,8 × 161,8 × 110,6	330
	SL7039	\$ 1.133,00	Standing Press	217,1 × 200,0 × 213,5 cm	326
	SL7040	\$ 760,00	Squat Lunge	169,4 × 166,8 × 63,6	330

					
CODE	PRICE	NAME	DIMENSIONS (cm)	PAGE	
	SL7041	\$ 1.141,00	Super Olympic Bench	241,0 × 174,3 × 162,2	333
	SL7042	\$ 2.460,00	Magic Rack / Smith Machine	227,4 × 231,4 × 238,6	322
	SL7043	\$ 415,00	Multi AB Bench	63,0 × 172,2 × 91,2	324
	SL7045	\$ 455,00	Vertical Knees Raise / Dip Stand	76,5 × 118,9 × 153,7	334
	SL7045OPT	\$ 175,00	Chin-up and Dip	113,0 × 118,9 × 238,7	334
	SL7046	\$ 1.340,00	Iso-Lateral Super Chest Press	217,1 × 249,2 × 113,2	326
	SL7047	\$ 419,50	Multi Hyper Extension	94,7 × 134,0 × 87,2	326
	SL7051	\$ 665,00	Assisted Nordic Ham	164,8 × 132,3 × 168,4	331
	SL7055	\$ 1.025,00	Belt Squat	197,2 × 151,1 × 113,7	330
	SL7057	\$ 1.050,00	Pendulum Squat	225,2 × 131,4 × 167,5	331





ECP Line

	ECP101	\$ 1.327,00	Shoulder Press	163,8 × 151,5 × 145,5	338
---	--------	-------------	-----------------------	-----------------------	-----

 CODE	 PRICE	 NAME	 DIMENSIONS (cm)	 PAGE
	ECP103	\$ 1.445,00	Pulldown	168,0 × 110,5 × 173,9
	ECP201	\$ 1.625,00	Chest Press	180,0 × 175,0 × 180,0
	ECP301	\$ 1.170,00	Pulldown	174,5 × 164,5 × 193,2
	ECP302	\$ 1.189,00	Seated Row	160,0 × 180,0 × 1110,0
	ECP306	\$ 1.645,00	Pullover	162,0 × 135,5 × 145,6
	ECP401	\$ 1.082,00	Abdominal	168,5 × 109,5 × 172,1
	ECP501	\$ 1.007,00	Seated Biceps	135,5 × 108,8 × 97,0
	ECP504	\$ 1.383,00	French Press	191,5 × 169,9 × 138,6
	ECP604	\$ 925,00	Prone Leg Curl	175,1 × 160,7 × 78,8
	ECP605	\$ 1.270,00	Seated Leg Extension	172,7 × 131,4 × 110,0
	ECP617	\$ 1.900,00	Hack Squat	218,5 × 129,0 × 141,6
	ECP625	\$ 1.440,00	Kneel Glute Kickback	175,1 × 160,7 × 78,8

				
CODE	PRICE	NAME	DIMENSIONS (cm)	PAGE
 ECP713	\$ 1.885,00	Squat	230,0 × 112,0 × 117,0	340
 ECP721	\$ 1.082,00	Smith	224,2 × 136,8 × 223,2	341

FE Line (EXOFORM)

 FE9701	\$ 1.799,00	Chest Press	156,5 × 122,9 × 149,0	344
 FE9702	\$ 1.725,00	Lat Pulldown	130,4 × 122,6 × 210,9	345
 FE9703	\$ 1.786,00	Arm Curl	156,7 × 114,9 × 149,0	346
 FE9704	\$ 2.038,00	Pectoral	119,7 × 155,1 × 148,9	344
 FE9705	\$ 1.712,00	Leg Extension	124,0 × 149,2 × 149,0	347
 FE9706	\$ 1.901,00	Seated Leg Curl	124,0 × 154,1 × 148,8	348
 FE9708	\$ 1.685,00	Abductor-Adductor	151,4 × 172,7 × 148,8	347
 FE9710	\$ 2.525,00	Leg Press	134,8 × 178,6 × 148,9	348
 FE9712	\$ 1.725,00	Shoulder Press	142,2 × 176,5 × 149,0	344

	 CODE	 PRICE	 NAME	 DIMENSIONS (cm)	 PAGE
	FE9714	\$ 1.406,50	Abdominal	120,2 × 138,3 × 149,1	346
	FE9715	\$ 1.785,00	Pec Fly / Rear Delt	172,1 × 134,0 × 149,0	344
	FE9716	\$ 1.685,00	Calf Raise	118,7 × 123,0 × 174,5	348
	FE9718	\$ 2.328,00	Torso Rotation	119,0 × 114,9 × 150,6	347
	FE9719	\$ 1.822,00	Row	112,7 × 199,6 × 149,2	346
	FE9720	\$ 1.986,00	Weight Assisted Chin / Dip Combo	175,0 × 138,0 × 219,8	345
	FE9721	\$ 1.551,00	Prone Leg Curl	119,3 × 170,5 × 149,2	348
	FE9723	\$ 1.722,00	Tricep	158,0 × 114,9 × 149,0	345
	FE9724	\$ 2.275,00	Lateral Raise	126,6 × 126,1 × 149,1	345
	FE9726	\$ 1.578,00	Glute	130,7 × 155,8 × 148,8	347
	FE9732	\$ 1.643,00	Back Extension	122,3 × 138,3 × 148,9	346
	FE97WS200	\$ 259,00	Weight Stack	—	349

	CODE	PRICE	NAME	DIMENSIONS (cm)	PAGE
	FE97WS235	\$ 292,50	Weight Stack	—	349
	FE97WS295	\$ 366,00	Weight Stack	—	349

IT95 Line

	IT9501	\$ 1.240,00	Chest Press	147,5 × 119,1 × 150,6	353
	IT9502	\$ 1.258,00	Lat Pull	138,0 × 143,4 × 188,9	356
	IT9503	\$ 1.064,00	Arm Curl	120,8 × 122,5 × 150,7	356
	IT9504	\$ 1.365,00	Pectoral	144,9 × 136,1 × 150,7	354
	IT9505	\$ 1.174,00	Leg Extension	118,5 × 122,0 × 150,6	360
	IT9506	\$ 1.300,00	Seated Leg Curl	118,6 × 153,6 × 150,6	360
	IT9508	\$ 1.190,00	Abductor and Adductor	89,7 × 155,3 × 150,6	358
	IT9509	\$ 1.295,00	Total Hip	129,2 × 97,2 × 150,6	360
	IT9510	\$ 1.865,00	Leg Press	113,7 × 185,0 × 150,6	359

	 CODE	 PRICE	 NAME	 DIMENSIONS (cm)	 PAGE
	IT9512	\$ 1.249,00	Shoulder Press	144,3 × 156,0 × 151,0	356
	IT9514	\$ 1.048,00	AB Machine	114,8 × 134,6 × 158,1	357
	IT9515	\$ 1.173,00	Pec Fly / Rear Delt	127,5 × 127,1 × 204,8	354
	IT9516	\$ 1.080,00	Calf Raise	115,6 × 128,7 × 173,9	360
	IT9517	\$ 1.342,00	Dip Press	123,3 × 169,4 × 150,6	354
	IT9518	\$ 1.128,00	Torso Rotation	119,0 × 114,9 × 150,6	357
	IT9519	\$ 1.266,00	Row	126,4 × 161,6 × 150,6	356
	IT9520	\$ 1.355,00	Weight Assisted Chin / Dip Combo	157,3 × 131,5 × 228,6	355
	IT9521	\$ 1.096,00	Prone Leg Curl	114,5 × 145,8 × 150,6	358
	IT9522	\$ 1.167,00	Lat Pulldown / Vertical Row	122,3 × 189,7 × 222,8	355
	IT9524	\$ 1.056,00	Lateral Raise	121,3 × 122,2 × 150,6	357
	IT9525	\$ 1.190,00	Adjustable Hi/Lo Pulley	146,3 × 126,2 × 235,8	353

 CODE	 PRICE	 NAME	 DIMENSIONS (cm)	 PAGE	
	IT9526	\$ 1.188,00	Glute	121,7 × 161,5 × 150,6	358
	IT9527	\$ 2.635,00	4 Stack Multi-Station	221,4 × 348,9 × 238,2	353
	IT9527OPT	\$ 236,00	Cable Crossover Traditional	282,4 × 47,7 × 22,1	352
	IT9528	\$ 1.422,00	Leg Extension / Leg Curl	123,0 × 137,5 × 150,6	359
	IT9529	\$ 1.422,00	Multi Press	143,7 × 182,7 × 166,9	355
	IT9530	\$ 1.802,00	Dual Adjustable Pulley	162,0 × 137,0 × 227,0	353
	IT9532	\$ 1.055,00	Back Extension	118,8 × 123,3 × 150,6	358
	IT9533	\$ 1.245,00	Bicep/Tricep	122,5 × 130,0 × 150,6	355
	IT9534	\$ 1.270,00	Abdominal / Back Extension	118,9 × 119,6 × 150,6	357
	IT9537	\$ 1.350,00	Standing Multi Flight Machine	145,5 × 90,6 × 186,3	354
	IT9538	\$ 925,00	Hip Thrust	156,3 × 129,0 × 150,6	359
	IT9539	\$ 1.616,00	Seated Leg Press Hack Squat	185,7 × 109,0 × 150,6	359









	CODE		PRICE		NAME		DIMENSIONS (cm)		PAGE
	IT95WS160		\$ 235,00		Weight Stack		—		352
	IT95WS200		\$ 294,00		Weight Stack		—		352
	IT95WS235		\$ 348,00		Weight Stack		—		352
	IT95WS295		\$ 437,00		Weight Stack		—		352

IF93 Line







	IF9301		\$ 822,00		Chest Press		136,0 × 118,8 × 153,0		365
	IF9302		\$ 802,00		Lat Pulldown		131,8 × 158,3 × 189,1		368
	IF9303		\$ 701,00		Arm Curl		102,8 × 121,6 × 153,0		367
	IF9304		\$ 872,00		Pectoral		173,6 × 80,6 × 153,0		365
	IF9305		\$ 810,00		Leg Extension		104,8 × 114,6 × 153,0		370
	IF9306		\$ 912,10		Seated Leg Curl		103,4 × 144,8 × 153,0		370
	IF9308		\$ 988,50		Abductor / Adductor		93,5 × 157,0 × 153,0 .		370

















 CODE	 PRICE	 NAME	 DIMENSIONS (cm)	 PAGE	
	IF9310	\$ 920,00	Leg Press	116,8 × 205,5 × 153,0	371
	IF9312	\$ 810,00	Shoulder Press	145,6 × 145,0 × 153,0	367
	IF9314	\$ 735,00	Abdominal	100,8 × 108,5 × 153,0	369
	IF9315	\$ 872,00	Pectoral	149,3 × 142,1 × 186,3	366
	IF9316	\$ 791,00	Calf Raise	110,5 × 115,0 × 177,5	370
	IF9317	\$ 814,20	Seated Dip	121,2 × 122,7 × 153,0	367
	IF9318	\$ 828,00	Torso Rotation	124,0 × 110,3 × 153,0	368
	IF9319	\$ 791,50	Vertical Row	85,8 × 180,4 × 153,0	368
	IF9320	\$ 855,80	Weight Assisted Chin / Dip Combo	130,9 × 125,6 × 249,8	366
	IF9321	\$ 805,50	Prone Leg Curl	114,6 × 150,7 × 153,0	371
	IF9322	\$ 934,00	Lat Pulldown	122,3 × 188,6 × 222,7	368
	IF9324	\$ 730,00	Lateral Raise	75,0 × 119,7 × 153,0	366











	 CODE	 PRICE	 NAME	 DIMENSIONS (cm)	 PAGE
	IF9325	\$ 602,00	Adjustable Hi/Lo Pulley	144,9 × 125,8 × 233,8	365
	IF9326	\$ 727,00	Kick Back	106,8 × 103,4 × 153,0	369
	IF9327	\$ 1.635,00	4 Stack Multi-Station	244,5 × 342,7 × 233,8	365
	IF9327OPT	\$ 110,70	Cable Crossover Traditional	250,5 × 44,1 × 19,8	364
	IF9328	\$ 1.110,00	Leg Extension / Leg Curl	127,0 × 127,2 × 153,0 .	371
	IF9329	\$ 1.090,00	Multi-Press	144,6 × 202,6 × 153,0 .	366
	IF9330	\$ 1.230,00	Dual Adjustable Pulley	163,9 × 88,2 × 227,0.	364
	IF9332	\$ 794,00	Back Extension	103,4 × 112,0 × 153,0	369
	IF9333	\$ 924,00	Bicep Curl / Tricep Extension	120,3 × 132,7 × 153,0 .	367
	IF9334	\$ 1.046,00	Ab / Back	159,2 × 125,3 × 153,1	369
	IF9335	\$ 839,00	Abductor	94,6 × 158,3 × 153,0	369
	IF9336	\$ 840,00	Adductor	118,5 × 158,3 × 153,0	371

				
CODE	PRICE	NAME	DIMENSIONS (cm)	PAGE
 IF93WS160	\$ 215,20	Weight Stack	—	364
 IF93WS200	\$ 264,00	Weight Stack	—	364
 IF93WS235	\$ 312,00	Weight Stack	—	364
 IF93WS295	\$ 399,00	Weight Stack	—	364





IT70 Line









 IT7001	\$ 1.493,00	Smith	224,1 × 132,6 × 237,0	378
 IT7002	\$ 244,00	Seated Preacher Curl	80,0 × 95,3 × 88,2	375
 IT7003	\$ 418,00	AB Bench	93,5 × 174,8 × 106,3	376
 IT7004	\$ 242,50	Stretch	55,2 × 127,4 × 99,7	377
 IT7005	\$ 305,20	Seated Calf Raise	75,1 × 135,5 × 83,9	377
 IT7006	\$ 1.194,00	Leg Press / Hack Squat	97,5 × 218,1 × 149,3	377
 IT7007	\$ 328,00	Multi Hyperextension	74,9 × 131,2 × 102,5	376















	 CODE	 PRICE	 NAME	 DIMENSIONS (cm)	 PAGE
	IT7009	\$ 201,20	Flat Bench	74,9 × 120,0 × 42,6	378
	IT7010	\$ 346,00	Vertical Knee Raise / Dip Stand	78,1 × 113,1 × 151,5	375
	IT7010EOPT	\$ 174,00	Chin-Up Accessory	70,0 × 93,2 × 235,1	375
	IT7011	\$ 290,00	Multi-Adjustable Bench	75,1 × 121,7 × 105,9	378
	IT7012	\$ 455,00	Dumbbell Rack	158,0 × 81,4 × 98,2	379
	IT7013	\$ 358,70	Multi AB Bench	74,9 × 172,2 × 89,8	376
	IT7014	\$ 508,00	Flat Bench	165,8 × 165,7 × 137,3	374
	IT7015	\$ 672,00	Incline Bench	165,8 × 168,2 × 137,3	374
	IT7016	\$ 595,00	Decline Bench	165,8 × 212,0 × 137,3	374
	IT7017	\$ 216,00	Weight Plate Tree	60,6 × 93,8 × 120,9	379
	IT7018	\$ 343,00	Dumbbell Rack	158,0 × 81,4 × 93,8	379
	IT7019	\$ 499,00	Incline Row	100,9 × 196,2 × 126,2	374

	 CODE	 PRICE	 NAME	 DIMENSIONS (cm)	 PAGE
	IT7020	\$ 1.110,00	45 Leg Press	101,6 × 220,5 × 149,4	377
	IT7027	\$ 423,50	Barbell Rack	91,9 × 94,9 × 161,2	379
	IT7030	\$ 236,00	Abdominal Bench	72,6 × 98,5 × 62,5 .	376
	IT7031	\$ 514,00	Shoulder Bench Press	134,9 × 112,6 × 165,1 .	375
	IT7032	\$ 270,00	Olympic Bar Rack	96,0 × 71,0 × 108,6	379
	IT7033	\$ 1.800,00	Max Rack	211,7 × 148,8 × 218,6	378



ITF8 Line















	ITF8101	\$ 587,90	Olympic Shoulder Bench	171,7 × 130,7 × 185,0	383
	ITF8102	\$ 185,90	Utility Bench	133,1 × 84,4 × 103,8	386
	ITF8201	\$ 889,50	3-way Olympic Bench	240,1 × 171,9 × 155,8	383
	ITF8202	\$ 367,80	Olympic Flat Bench	171,8 × 170,3 × 125,4	382
	ITF8202OPT	\$ 162,00	Safety Bar Attachment	76,3 × 25,0 × 57,6	382

					
CODE	PRICE	NAME	DIMENSIONS (cm)	PAGE	
	ITF8203	\$ 536,50	Olympic Incline Bench	171,8 × 215,6 × 125,4	382
	ITF8204	\$ 491,00	Olympic Decline Bench	171,8 × 182,2 × 145,0	382
	ITF8301	\$ 317,00	Seal Row Bench	132,8 × 127,5 × 97,3	384
	ITF8401	\$ 328,30	Adjustable AB Bench	172,2 × 73,5 × 89,8	384
	ITF8402	\$ 387,60	Adjustable Back Extension Bench	179,7 × 71,6 × 106,7	385
	ITF8404	\$ 211,20	Roman Bench	118,2 × 65,7 × 69,2	384
	ITF8406	\$ 625,90	Glute & Ham Bench	129,9 × 96,9 × 128,1	385
	ITF8501	\$ 227,70	Seated Arm Curl Bench	104,5 × 81,6 × 87,9	384
	ITF8601	\$ 613,90	Squat Rack	177,6 × 172,2 × 189,0	386
	ITF8613	\$ 480,50	Hip Thrust Bench	155,3 × 104,6 × 48,9	385
	ITF8618	\$ 258,30	Sissy & Split Squat Bench	86,7 × 72,1 × 64,8	385
	ITF8701	\$ 352,00	Knee Raise	119,9 × 78,7 × 151,1	383



					
CODE	PRICE	NAME	DIMENSIONS (cm)	PAGE	
	ITF8702	\$ 578,00	Chin Up & Knee Raise	138,9 × 134,4 × 237,7	383
	ITF8721	\$ 1.050,00	Vertical Smith	121,6 × 224,2 × 230,9	387
	ITF8722	\$ 1.445,00	7° Smith	122,6 × 224,1 × 230,9	387
	ITF8801	\$ 149,80	Flat Bench	133,9 × 67,3 × 43,0	385
	ITF8802	\$ 296,40	Fi-Bench	143,6 × 69,9 × 43,0	384
	ITF8805	\$ 472,20	Barbell Rack	88,7 × 74,4 × 142,6	386
	ITF8806	\$ 143,50	Plate Rack	96,1 × 71,6 × 121,2	386
	ITF8809	\$ 302,40	Dumbbell Rack (For Hexagonal Dumbbells)	198,0 × 85,6 × 92,8	387
	ITF8810	\$ 458,80	Dumbbell Rack (For Round Dumbbells)	198,0 × 85,6 × 93,7	387













Encore Line

	ECE5	\$ 1.370,00	ECE5	81,2 × 184,9 × 178,0	395
	ECR7	\$ 1.092,00	ECR7	64,2 × 167,1 × 131,9	394



				
CODE	PRICE	NAME	DIMENSIONS (cm)	PAGE
 ECT7	\$ 1.855,00	ECT7	94,0 × 205,1 × 145,9	395
 ECU7	\$ 915,00	ECU7	62,8 × 113,2 × 147,2	394
 ES2000OPT1	\$ 21,90	Pivot	50,0 × 15,0 × 18,0	393
 ES2000OPT2	\$ 56,00	Pull Down Bar + Roller	126,5 × 25,5 × 13,0	393
 ES2100	\$ 1.834,00	ES2100	192,5 × 144,7 × 218,0	391
 ES3000	\$ 3.185,00	ES3000	364,2 × 292,9 × 217,7	390
 ES3000OPT	\$ 321,00	HiLo Pulley Attachment	37,6 × 81,9 × 214,5	393
 ES7011	\$ 273,40	Bench	52,5 × 144,0 × 49,0	393
 ES9030	\$ 1.520,00	ES9030	173,4 × 112,3 × 215,0	392

PL Line

 PL9002	\$ 760,00	Lat Pulldown / Seated Row	102,0 × 176,5 × 218,2	398
 PL9010	\$ 915,00	Leg Press / Calf Raise	114,7 × 216,5 × 152,0	398

	 CODE	 PRICE	 NAME	 DIMENSIONS (cm)	 PAGE
	PL9016	\$ 821,00	Inner / Outer Thigh	173,9 × 160,9 × 152,0	399
	PL9019	\$ 943,00	Leg Extension / Leg Curl	124,5 × 146,5 × 152,0	399
	PL9021	\$ 863,00	Multi Press	132,4 × 193,2 × 152,0	398
	PL9022	\$ 865,00	Rear Deltoid / Pectoral Fly	129,9 × 136,5 × 206,1	398
	PL9023	\$ 540,00	Biceps / Triceps	116,4 × 120,7 × 151,3	399
	PL9024	\$ 776,00	Ab / Low Back	109,9 × 104,4 × 152,0	399
	PLWS170	\$ 235,50	Weight Stack	—	399
	PLWS250	\$ 348,00	Weight Stack	—	399

IFP Line

	IFP1101	\$ 421,50	Seated Shoulder Press	157,9 × 152,0 × 106,9 .	402
	IFP1103	\$ 316,50	Standing Lateral Raise	116,5 × 88,5 × 155,0 .	402
	IFP1201	\$ 365,00	Seated Chest Press	127,6 × 98,4 × 124,8 .	402

				
CODE	PRICE	NAME	DIMENSIONS (cm)	PAGE
	IFP1206	\$ 376,20	Standing Chest Fly	131,0 × 151,5 × 149,1 . 402
	IFP1301	\$ 477,80	Lat Pulldown Όργανο Έλξεων Πλάτης	70,8 × 109,2 × 128,7 . 403
	IFP1302	\$ 415,00	Seated Row	102,0 × 147,0 × 134,0 . 403
	IFP1305	\$ 279,50	T-Bar Row Όρθια Κωπηλατική	207,9 × 90,8 × 63,5 . 404
	IFP1501	\$ 366,90	Bicep Curl Όργανο Κάμψεων Δικεφάλων	130,2 × 70,7 × 98,8 . 403
	IFP1604	\$ 375,40	Prone Leg Curl	120,2 × 162,3 × 79,8 . 406
	IFP1605	\$ 349,00	Seated Leg Extension	117,3 × 124,6 × 99,5 . 406
	IFP1607	\$ 609,00	Standing Adduction	134,1 × 141,9 × 146,1 . 405
	IFP1613	\$ 558,00	Vertical Leg Press	165,5 × 121,4 × 171,1 . 407
	IFP1614	\$ 555,00	Hip Thrust	129,2 × 144,9 × 78,4 . 405
	IFP1615	\$ 395,80	Belt Squat	125,0 × 161,5 × 103,2 . 407
	IFP1616	\$ 382,00	Vertical Hip Thrust	122,0 × 109,8 × 116,5 . 404

	 CODE	 PRICE	 NAME	 DIMENSIONS (cm)	 PAGE
	IFP1617	\$ 762,00	Hack Squat	148,5 × 198,2 × 131,8 .	407
	IFP1619	\$ 345,00	Reverse Hyperextension	79,7 × 131,0 × 115,3 .	405
	IFP1622	\$ 439,00	Standing Hip Abductor	59,5 × 172,0 × 128,0 .	405
	IFP1623	\$ 205,50	Seated Calf Raise	56,6 × 136,8 × 84,9 .	406
	IFP1706	\$ 301,00	Biceps / Triceps	70,8 × 109,2 × 128,7 .	403
	IFP1707	\$ 571,00	Leverage Squat / Calf	144,5 × 149,0 × 155,0 .	406
	IFP1711	\$ 736,00	Hack Squat / Leg Press	102,0 × 263,4 × 137,3 .	407
	IFP1721	\$ 725,00	Half Cage / Smith Machine	185,0 × 140,4 × 234,3 .	404
	IFP1721OPT	\$ 340,00	Lat Pulldown Seated Row Attachment	123,1 × 145,1 × 230,7 .	404

Χάρτες των περιοχών στέγασης των εγκαταστάσεων της ΕΛΔΙΚΟ ΣΠΟΡ ΜΟΝ. ΑΕΕ σε Αθήνα και Θεσσαλονίκη



ΚΕΝΤΡΙΚΟ ΚΑΤΑΣΤΗΜΑ: Κασσάνδρας 30, Τ.Κ.: 104 47 Αθήνα (Βοτανικός) • Τηλ.: 210 34 78 279 (6 γραμμές), Fax: 210 34 50 168

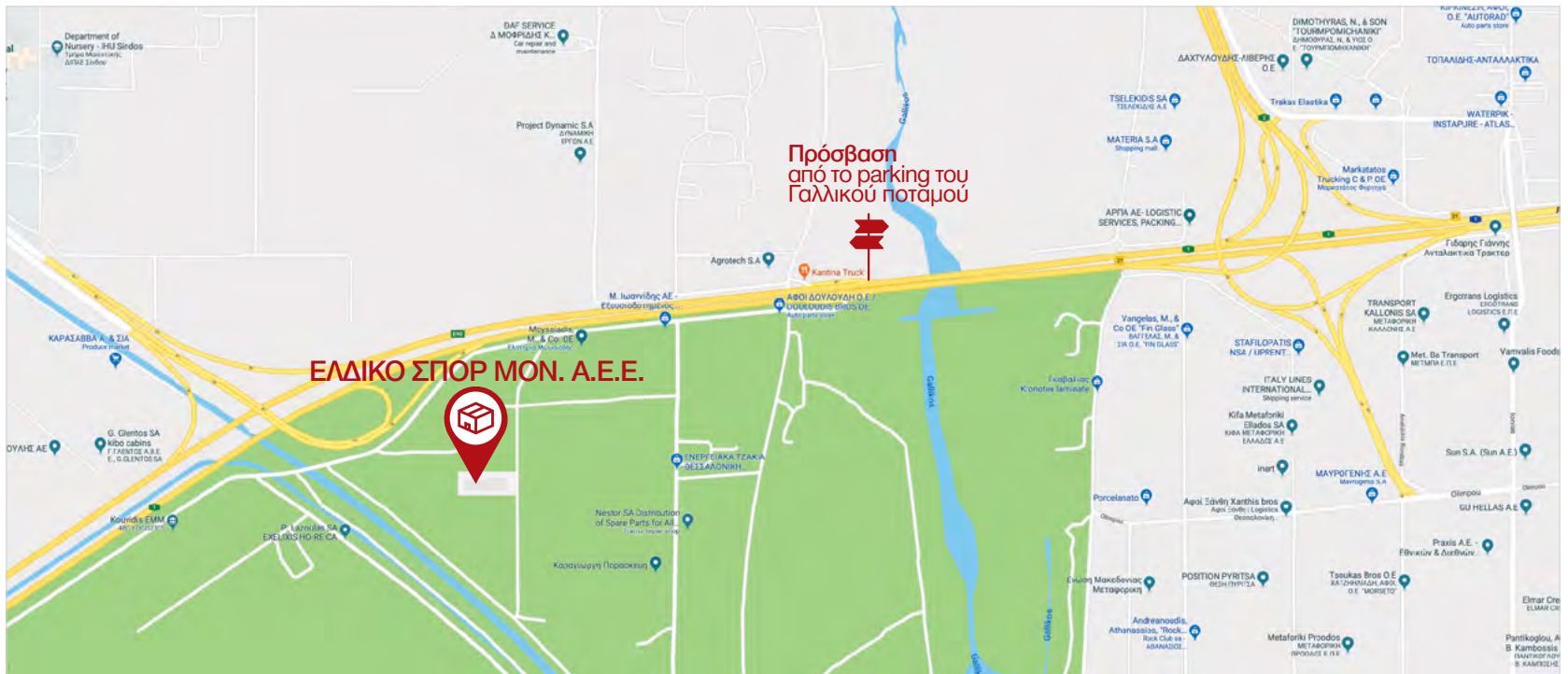

ΥΠΟΚΑΤΑΣΤΗΜΑ: 8^ο χλμ. Θεσ/νίκης-Αθίνας, Τ.Κ.: 574 00 Σίνδος (Θεσ/νίκη) • Τηλ.: 2310 57 00 37 (4 γραμμές), Fax: 2310 79 69 58

AMiLA **SPiRiT** **SOLE** **TOTALGYM** **MiKASA** **FOX40** **STAG**

Για την αποστολή επιταγών μπορείτε να χρησιμοποιήσετε: Spredex Courier και Συστημένη Επιστολή των Ελληνικών Ταχυδρομείων (ΕΛΤΑ) - **ΠΡΟΣΟΧΗ:** για ταχυδρομικές αποστολές μόνο στη διεύθυνση Αθηνών

**ΤΡΑΠΕΖΙΚΟΙ
ΛΟΓΑΡΙΑΣΜΟΙ
ΚΑΤΑΘΕΣΕΩΝ**

EuroBank: 00260204250200103614
IBAN: GR 7002602040000250200103614
ΠΕΙΡΑΙΩΣ: 5082023708714
IBAN: GR 2601720820005082023708714

AlphaBank: 105002002018462
IBAN: GR 9201401050105002002018462
ΕΘΝΙΚΗ: 138/470625-05
IBAN: GR 6601101380000013847062505

Σημαντική Προσθήκη: παρακαλούμε στην “αιτιολογία” να αναγράφεται πάντοτε η επωνυμία της επιχείρησης

κατάλογος και
τιμοκατάλογος

2024

Σύμβουλος Αγορών

AMILA®

in impulse

ReNegade

SPIRIT

SOLE

TOTAL GYM 

BODYCRAFT

Κεντρική Αποθήκη: ΚΑΣΣΑΝΔΡΑΣ 30, Τ.Κ. 104 47
ΑΘΗΝΑ (ΒΟΤΑΝΙΚΟΣ)

Τηλ. Κέντρο: 210 34 78 279 (6 γραμμές), Fax: 210 34 50 168

Υπ/μα Β. Ελλάδος: 8° χλμ. ΘΕΣ/ΝΙΚΗΣ - ΑΘΗΝΩΝ
Τ.Κ. 574 00 ΣΙΝΔΟΣ (ΘΕΣΣΑΛΟΝΙΚΗ)

Τηλ. Κέντρο: 2310 57 00 37 (4 γραμμές), Fax: 2310 79 69 58

e-mail: support@eldico.gr • web site: <http://www.eldico.gr/>

ELDICO sport



www.amila.gr

AMILA *in* impulse ReNegade SPIRIT SOLE TOTAL GYM 
BODYCRAFT MIKASA FOX40 SUNFLEX  Butterfly STAG

News/Updates

CHANGES IN THE CATALOGUE

= IMPORTANT CHANGE /

= NEW ITEM /

= SMALL CHANGE IN SPECS /

= PRICE CHANGE

Date	Code	Change	Go
21/04/2026	95137-95138	Arc Gradus plyometric box in two sizes	
	48073	Power Pilates Ball	
	94491-94494	Flooring from recycled rubber with 20% or 30% EPDM	
	43923	Primo Robur Dumbbell Rack	
	92236	Flow F250PI treadmill, with a DC 2,5hp motor and 125x45cm belt	
	92237	Velos BRF300PI treadmill, with a Brushless DC 3,0hp motor and 142x50cm belt	
02/04/2026	—	ITF8 Line. This series by Impulse is the continuation, expansion, and improvement of the well-known and popular IT70 Line	
	RE700B	The well known commercial quality Impulse's elliptical, now also available in black color	
	RR500B & RR700B	Impulse's recumbent bikes also available in black color	
	RU500B & RU700B	Same with the upright bikes	
	PS460 & PS450	The high-ranking spin bikes by Impulse in two colors	
	PB300B	The smaller spin bike is also available in black color	
	RT750B	Naturally, the commercial treadmill couldn't be missing from the all-black look	
	XSC700	Stair machine by Impulse	
	99751-99759	Pilates rings, 3 new colors, 3 resistance levels each color, choose the one you need and like	
	44678, 44679	Two more weights (28 & 32 kg) in the line of the cast iron kettlebells	
	95205	Primo Skald Squat Stand	
	81729, 81752, 81753	EVA mats with eyelets, in neutral colors	
	96838	Soft foam roller, medium roughness, black color	
	44160	New design to the weighted vest	
	43087	Boxball "F3"	
11/02/2026	44746	Wall-mounted Double Pulley "Tug", suitable for commercial use	
19/01/2026	44821	Treadmill SOLE F85 MY2023	
12/01/2026	43702-43705	Forte MMA and bag gloves	

Date	Code	Change	Go
	43841-43843	Changes to the design of the boxing bags	
	43887-43888	Changes to the design/look of the speed ball	
	95136	Changes to the design/look of the plyometric box	
	90677-90678	New design/colors to the power bags	
	32006-32008	Forte boxing gloves	
	43951	Blaze storage rack for medicine and slam balls	
	84627	AB Cushion, new color on the lower perimeter	
10/12/2025	41913	Handy Pocket Gym Timer	
	95106	Weighted vest	
	96607-96611	Rubber Loop Bands	
	96616	Trinity Hip Loop Band Set	
	92701	5pcs multiple-grip lat pull-down bars	
	44209	The well-known simple and economical exercise mat, now also in black color	
07/11/2025	84846-84850	Color Bumpers Slim	
	99865-99866	Balu yoga/pilates socks	
	—	New colors of Bellulu yoga/pilates socks	
	91552	Amila Tronic Commercial Hip Thrust	
	95356	Swivel for Yoga Swing	
	95808, 95821	New pilates balls, bulk packing, in the Trinity series' colors	
21/10/2025	96837-96837	Foam Roller Trinity	
	96959	Foot Massage Roller	
	84560-84561	Tempo Plyometric Box	
	90810-90816	Plexus Slam Ball	
	88155-88157	Trinity Pilates Ring	
17/09/2025	—	Modular and ergonomic ARKON Storage Rack, allows you to create your own unique setup	